



# CATALOGUE 2024

HEPCO & BECKER



## OUR COVER IMAGE THIS YEAR

There's no room for boredom here. Once again, the manufacturers have some exciting models lined up to ensure plenty of fun in the coming 2024 motorcycle season. And of course, we are working as fast as we can to deliver premium accessories for all these motorcycles in the Hepco & Becker quality you know and love. We have a very special place in our hearts for two of these models in particular: Honda's new and long-awaited Transalp, and Suzuki's new adventure bike, the V-Strom 800. You will find plenty of accessories for both on the following pages.

But you can get already a first idea of what awaits you from this year's catalogue cover and the page 2. Of course, sophisticated luggage solutions and a range of different components for actively and passively protecting your motorcycle and its passengers are all included. But we also offer you supplies for almost all other new motorcycles and, as has been our tradition for 45 years, also for countless models that have been cruising around the world's roads for years and decades.

What's more, we deliberately decided to play things closer to home for our cover image this year. Transalp and V-Strom wheel across the Martinshöhe through the diverse Western Palatinate, right on our doorstep. Page 2 features a stop in the wildly romantic Karlstal gorge. With its quaint sandstone rocks, it is one of the most beautiful gorges in the Palatinate Forest and is located very close to the legendary biker meeting point of Johanniskreuz, making it the perfect region for any successful motorcycle tour.

And if you're out and about in the area, feel free to pay us a visit. There is always something to discover and we'll be delighted to have you.

Until then, we send you our warmest regards from Pirmasens.

**The product contents list can be found from page 15 onwards.**

**HEPCO & BECKER**

# TEAMWORK



Unfortunately, it is no secret – almost everywhere we look, we are faced with bad news and little hope.

But our trade fair experience at the EICMA 2023 in Milan in November was a far different story. Well over half a million cheerful and interested individuals packed into the eight fully sold out halls of the trade fair to get inspired by the vast number of new motorcycle models and huge range of accessories on offer. Of course, we were also part of the action with our prestigious stand and took part in countless fascinating discussions over the six days.

And we brought this positive feeling back with us to our premises and everyday work. After all, it is also a powerful incentive for the team in our Development department. Day after day, they ultimately face the challenge of designing, testing and perfecting high-quality accessories in good time. We are delighted to introduce our “Makers” to you over the following pages and to grant you a peek behind the scenes here at Hepco & Becker.

Once again, you will find plenty of new items in this catalogue. But we have also revised some of our popular products and given them a new look. Get ready for a surprise and take some time to have a look through. As usual, you can find accessories for brand-new models arriving on the market in 2024 on our website at [www.hepco-becker.de](http://www.hepco-becker.de). If you cannot find what you are looking for there, our expert Sales team will be happy to help you further by telephone.

If you would like to meet us in person, you can find us at the motorcycle trade fairs in Friedrichshafen, Munich, Dortmund and Tulln in beautiful Austria in 2024. And of course, at the EICMA in Milan once again. We are, of course, always there for you at our premises in Pirmasens, both in Workshop Sales and Workshop Assembly.

As always – we look forward to meeting you and wish you a happy, safe 2024 packed with plenty of adventure. Thank you for your continued loyalty!

**The Hepco & Becker team**

**HEPCO & BECKER**

## ENVIRONMENTALLY FRIENDLY AND SUSTAINABLE MANAGEMENT

At Hepco & Becker, we stand by our honest promise to bring only durable, high-quality products to the market, worldwide and at all times. Early on in our company's forty-year history, it was important to us to carefully balance ecological and economic concerns and to bring them into a sensible relationship. Sustainability is more than just a buzzword for us – we embody it and see ourselves as responsible for people and nature today and in the future.

Our strategy is not only to strive for economic sustainability, but also to focus on environmental and socio-ecological sustainability. This already begins with the development and manufacture of our products. This includes short distances, the reduction of material and energy consumption as well as nature-friendly material cycles and waste avoidance. For example, we conserve valuable resources by using our own solar power, recycle production residues externally using a sophisticated recycling concept, and strive not only to comply with recognised environmental standards in production, but also to exceed them.

We also ensure the sustainability and longevity of our products through our qualified, fast and widely praised repair service. We keep our products „alive“. Defective components are largely replaced or repaired by us. Nothing is more environmentally friendly and efficient than maintaining existing parts. The production process of our leather and its control are also important factors for us. First and foremost, we require species-appropriate animal husbandry and expect the leather to be tanned in full compliance with European environmental standards. We also make progress with many small steps. For example, we offset CO2 emissions caused by our paper consumption by participating in a climate protection project in Brasilia. This saving alone would be enough to circumnavigate the globe several times by motorcycle.



## SOCIAL AND HUMAN RESPONSIBILITY

Hepco & Becker is a globally active, medium-sized company and a major manufacturer in the field of motorcycle accessories. For 45 years now, motorcycles have been upgraded and personalised with our model-specific products. We currently employ around 80 people at our site in Pirmasens. We place great importance on ensuring that the people who manufacture our products are paid fairly. Therefore, we demand from our producers and suppliers that they pay their employees appropria-

tely too. Respect and decency dictate that people should be able to live from their work and find socially acceptable working conditions. Our employees should not only be able to perform their work safely, but also remain healthy. We stand by our special responsibility towards our employees, which does not end at the factory gate. It is also important for us to be involved in local associations and to provide financial support for children's and youth work.

# SOCIAL MEDIA

*Instagram* + ♥ 📍

 **@hepcobecker**  
motorcycle accessories



♥ 🗨️ 📍 🔖

hepcobecker Suit up your bike and step in the hepcobecker circle!  
#hepcobecker #suitupyourbike #motorcycle #accessories

🏠 🔍 + ♥ 👤

 YouTube



Be part of the Hepco&Becker circle SUBSCRIBE

 **HepcoBecker EN**  
EICMA 2022  
Suit up your bike and step in the hepcobecker circle!

▶ Daniel Explains: Junior / Junior Flash Topcases 4:06
▶ Daniel Explains: Junior / Junior Flash side cases 1:12
▶ Daniel Explains: Xplorer Cutout Set 2:28
▶ Daniel Explains: Complete carrier 2:04
▶ Daniel Explains: Xtravel C-Bow 3:48

Daniel Explains: BikeSpecial ▶ Play all

▶ Daniel Explains: BikeSpecial TRUMPF Enduro 660 4:12
▶ Daniel Explains: BikeSpecial APRILIA SR GT 125 Sport 2:21
▶ Daniel Explains: BikeSpecial YAMAHA XSR 700 4:18
▶ Daniel Explains: BikeSpecial ROYAL ENFIELD Scram 411 3:43
▶ Daniel Explains: BikeSpecial YAMAHA T700 World Raid 5:23

Daniel Explains! ▶ Play all

▶ Daniel Explains: LED auxiliary headlights 2:15
▶ Daniel Explains: Street rear bag 4:23
▶ Daniel Explains: Xplorer series 5:31
▶ Daniel Explains: Xtravel C-Bow 4:43
▶ Daniel Explains: Reyster Neo 4:48

- Follow us & receive benefits as a result:
- Special assembly videos on bikes that sell well.
  - Vehicle + product presentation through emotional images.
  - Repost our posts with #hepcobecker to increase the reach of your own channels



#HEPCOBECKER  
@HEPCOBECKER

# HISTORY OF THE COMPANY



Hepco&Becker, a name that guarantees quality and stands for service for motorcycles. The one-man operation was founded in 1973 by engineer Franz Becker, who was involved in a fatal motorcycle accident in 1975. The business was continued and developed into a medium-sized company by young student Paul Ehrhardt. Its production in the early days involved essential metal parts.

1984 marked the takeover of hard-shell case production by Hepting & Co. from Stuttgart Feuerbach and the foundation of Hepco&Becker GmbH as the continuation of Franz Becker GmbH. Hepting was once one of the largest suitcase manufacturers with more than one thousand employees in Germany. In the seventies and the beginning of the eighties, Hepting manufactured thousands of motorcycle cases for BMW and Krauser.

Thanks to in-house case production, Hepco&Becker successfully provided new, attractive products and assumed a leading role on the market. Whilst a number of competitors have disappeared, Hepco&Becker has managed to remain successful to this day. The rhino became a key concept for the Hepco&Becker brand.

It represents independence and robustness, power and durability, just like every item that comes out of the Hepco&Becker establishment. The rhino has high loyalty values for many motorcyclists as it is not so easy to dissuade thanks to a certain stubbornness. Sustainability and reliability are, to this day, values which shape and define day-to-day business at Hepco&Becker.



HEPCO&BECKER

*Classic*  
SINCE 1975

Picture taken in 1978  
Far left: Paul Ehrhardt, then Managing Director



**HEPCO & BECKER**

# THE COMPANY TODAY

Hepco&Becker is a globally active, medium-sized company and a major manufacturer of motorcycle accessories with a brand profile. Motorcycles have been upgraded and customised with model-specific products for over 45 years now, and we employ approx. 80 people at our site in Pirmasens. Customers from over 60 countries appreciate the quality and variety of the Hepco&Becker product range. Regardless of in which country you are travelling:

The Hepco&Becker brand is renowned for its genuine pledge to provide long-lasting and quality accessories. Hepco&Becker has grown sustainably since its founding, and combines traditional model diversity with innovative, high-quality products "Made in Germany". Components and carrier systems for over 1,000 motorbike models have been produced over the years. Small series of products can even be produced for classic and newer models. We can also manage specific requests from customers.

All our employees are motivated with a passion for bikes, based on their crucial, individual role in the company.

Our commitment is to ensure employment in the region, sustain eco-friendly production and to conduct respectful working relationships. Future-oriented investments are made in training young people who will benefit from the vast experience of our long-term employees. We implement a flat, hierarchical corporate structure and ongoing employee training to also serve the personal and professional development of each individual.

This is how we encourage an innovative spirit and the creativity to develop new products. This creative power forms the basis to expand our product range. At the same time, we strive to meet the high demands in terms of quality and products of our customers. Hepco&Becker is your "one-stop shop". This enables optimal networking between individual departments.

A production/warehouse area, with a surface area of 1800 square metres will enable us to invest in the most modern tube processing machines and welding technology.

Our logistics and warehouse management departments also need extra capacity for the thousands of items.



# IT ALL STARTS WITH IDEAS THAT ULTIMATELY BECOME REALITY





# PASSION-DRIVEN DEVELOPMENT

It is our goal to develop and manufacture high-quality products. By doing so, we are able to enhance motorcycles and offer every customer their own way to equip or convert their bike to suit their own ideas and needs.

But these ambitious goals can only be realised with an extraordinary team effort. A combination of years of experience and technical expertise, passion, ambition and love for life on two wheels enables us to constantly create new, beautiful and successful products that are a hit with every motorcycle enthusiast. We employ design, functionality and quality to bring about safety, emotions and exceptional experiences.

The motorcyclist with their ideas and needs determines what we develop. The desires and preferences of each individual often vary greatly. Technical innovation and a strive for modernity on the one hand, and a yearning for the past and rediscovery of the little things on the other give the world of two-wheelers ex-

citement and meaning.

We believe our strengths lie in understanding passion for motorcycling, knowing our customers and therefore understanding what they want.

Each new motorcycle offers new opportunities for improvement, change and personalisation. We use our decades of experience to examine each and every detail and analyse it for any weak points. This is a constantly ongoing process where our proximity to our customers and not least, our close-knit network, help us to come up with development ideas and implement them in the shortest time.

A small, elite team works with a great deal of passion and commitment in our Development department on how to put these ideas into practice.

At this point, it's time to let these people, who pursue our guiding principle day in day out, speak for themselves. We carried out a brief group interview in our Development office, where you may find out some interesting trade secrets.

## Confirmed quality!

Through recurring audits, TÜV Rheinland has confirmed for years that the internal standards for our products and processes meet the high quality standards of independent institutes. Our verified management system, which includes the development, production and sale of motorcycle accessories is aimed at offering products of the highest quality at all times.

Any products that are also subject to approval are given a General Operating Permit (ABE). This applies to any centre stand that leaves our company.

The required documents come with the centre stand, can be viewed on our website and can be downloaded according to type at any time.



You can rely on us, trust in our quality.

Choosing the Hepco & Becker brand always means relying on the highest quality. Quality that you can rely on for years to come and that we promise you beyond the statutory periods!

Hepco & Becker therefore voluntarily offers its customers a 5-year manufacturer's warranty.

Hepco & Becker assumes this manufacturer's warranty towards consumers for products in addition to the statutory warranty that the consumer is entitled to towards the seller.

This applies regardless of any mandatory statutory liability regulations, such as the Product Liability Act, in cases of intent and gross negligence by Hepco & Becker or its vicarious agents resulting in injury to life, body or health.



## QUESTIONS TO TEAM MEMBERS

**1. First things first: What do you generally consider important when developing new products?**

NA: *The answer varies greatly, and of course, depends on the product in question. Given that all of us are motorcyclists ourselves and spend a lot of time on the road, we're able to contribute our own experience to the process. Our main focus always lies with consumer benefits and functionality, as well as the question of whether we would screw the product onto our own motorcycle. We don't develop any products we don't believe in ourselves!*

*The high and constantly growing quality demands of our customers and our competition also motivate us to develop creative ideas for new products and to stay innovative.*

**2. Who decides and, based on which criteria, which product you develop for which motorcycle?**

NA: *We generally try to make decisions as a team, as each of us has our own different strengths and a lot of experience to share. Another important indicator for us is the motorcycle market or the vehicle manufacturers, who are always introducing new, highly interesting mo-*

*dels to the market, for which we can, of course, offer luggage solutions and protective gear.*

*We have a clear motto in this regard: "Yesterday's customer is and remains tomorrow's customer!" That's why we partly also develop products for niche vehicles and exotic models or focus on special requests from individual customers. Through our crafting manufactory, we are always able to produce small to very small series economically, and in turn, offer these to our customers.*

*Thanks to growing globalisation, we also have many national importers around the world that we have been cooperating with for many years. We always maintain close partnerships and regularly exchange information.*

*This entire development process takes no more than two days, which we consider a unique pace. This doesn't include our functional and practical testing, which always takes place afterwards.*

**3. A new motorcycle model comes in, and you want to develop a crash bar for it. How long will it be until the customer can buy it online or in store?**

NA: *It takes four to six weeks to transform an idea into the finished product.*

**HEPCO & BECKER**

During this time, we usually achieve development and are able to supply the customer with series parts. As soon as the motorcycle is standing on the lifting platform in our development workshop, we can get started! We are a well-coordinated team of mechanics and design engineers that work hand in hand. Together, we discuss the design and implementation, before our specialists begin opening up the screw points on the motorcycle, identifying mounting material such as screws and sleeves, and setting up the production machines. In the meantime, the initial angular steel bracket designs are created in the CAD system, which are produced and screwed to our machines as prototypes.

Steel tube bending is a supreme discipline! It takes lots of experience because we programme the machines for these freely from our head based on the design idea. This is followed by documentation and the careful creation of our installation instructions. Finally, we specify the data determined from these prototypes and produce the welding and testing gauges required for series production.

**4. It sounds like that was just the quick version! If we were to get more specific: Once the new motorcycle is on the lifting platform, what happens first?**

*MG: First, the motorcycle is lashed cleanly onto the lifting platform. Safety first!*

*AB: We don't do anything without detaching and taking off the sensitive trim parts! Development takes place directly on the motorcycle, where we take special care to avoid any damage.*

*MG: Then there is a team meeting directly by the motorcycle. Even before this, all those involved have already thought about what might be "missing" from the motorcycle. But it's only in reality, directly next to the bike, that they can check the implementation and have to take different approaches. Each person is able to contribute here. At any rate, we always try to implement our "standard programme" – protection, luggage, accessories.*

*MT: Yes, that's the goal! But we have to and want to have the motorcycle physically in the Development department to be able to decide what makes sense.*

*For example, with guards, it also very important to look at the structure of the motorcycle frame. It's only possible to see which mounting points are suitable for absorbing the arising forces as best as possible in the event of a crash once you've removed one or the other screw. Identifying these fixed points on the motorcycle is also decisive for the design.*

*AB: Out of all the requirements for development, it's worth remembering that*

## SERVICE is one of our top priorities!

Good, all-round service is just as important today as the quality of the product itself. Our customer service starts with good advice and will accompany you and your product at best for a lifetime.

Whether by telephone, email or via our social media channels, we are here to listen to you and your concerns. You can contact us at any time and will receive a competent answer as quickly as possible.

As a matter of conviction, we refuse to use chatbots or other AI-based software tools. We greatly value personal, direct interaction. You can therefore be sure that you will always get a response from trained employees with the right specialist knowledge for your issue. This starts, for example, with universal product advice and goes as far as the apparently simple request for a spare part.

Experience has to be experienced.

Each kilometre driven with Hepco & Becker accessories is also another test kilometre for our products. Whether offroad or on long, speedy motorway transfers in the constant rain. Each tour comes with new findings and experience. We are therefore always grateful for feedback and suggestions for products or constructive suggestions on how we can improve our products. We'll take the message seriously, engage with it and consider what is feasible and/or makes sense to gradually make our products even better.



## Quality on location. Hands down!

Where possible, we manufacture on location here in Pirmasens to be able to perform the necessary controls and quality assurance. Our long-term success proves us right and is probably also due to the fact that we work with capable, reliable partners and suppliers.

These existing, evolved partnerships will remain the cornerstone of our quality claims at Hepco & Becker in future. Where possible and after considering everything, we manufacture our products with conviction in Germany. The supply performance and deeply rooted quality awareness in this country confirm this attitude with each new day.

As a result, we continually invest in development and quality assurance here in Pirmasens. We consider the interlinking of both departments essential when it comes to new developments and product improvements and make sure to protect this level of quality in future.



## QUESTIONS TO TEAM MEMBERS

*the motorcycle is often only directly on the lifting platform for 2-3 days during the first stage. The first step is therefore to set priorities and meaningfully distribute tasks within the team. Efficiency plays a major role here.*

### 5. From where do you get your inspiration and feel for the right design of the tube parts?

*AB: There are many influencing factors here. Personal sense of taste, the existing framework conditions, such as frame/tube/trim connections and experience from countless developments and customer feedback are important here.*

*MT: Some of us are motorcyclists ourselves and therefore have a certain sense of taste. When you work in the Development department, you simply need to come with the right feel for design. Years of experience are also a tremendous help.*

### 6. Who is responsible, e.g. for how an engine guard finally looks?

*AB: It's a combination of the designed idea, technical implementation and function of the guard.*

*MG: Michael plays a huge role in the tube constructions, especially with gu-*

*ards. He's been around forever and knows what is feasible technically and for series production.*

*MD: The senior boss still gets involved. (Grins unanimously and winks)*

### 7. How do you know whether an engine guard is the right size and is able to withstand real-life conditions?

*MG: This is an interplay of experience, theoretical load analysis and practical tests. These take place during the quick meeting or on multiple photo and test tours. Long-term tests are mainly carried out by friendly motorbike travellers.*

*AB: The endurance tests on the test bench are important, especially for our cases and bags. This is not only the case for new developments, but also series parts.*

### 8. What base material is used for the tubes?

*MD: We use the following dimensions of steel, depending on the purpose: 32/25/22/18/16 x 2 mm*

*NA: We require a consistently high level of quality to ensure the required manufacturing precision. In addition, we need high tensile strength in the tubes for our products. This is a key quality character-*

ristic, particularly for guards. We therefore only buy German quality steel from renowned manufacturers.

MT: Particularly in the area of stainless steel tubes or chrome products, we place high demands on the quality of the raw material, as this is where the high-quality surface processing (glass bead blasting/ electropolishing with stainless steel or the chrome-plating process) reveals errors in the output material most.

#### 9. Are standardised tests carried out, and if yes, in which areas?

AB: We regularly perform vibration testing in the luggage division. To check the bags or even the rack constructions. The TÜV regularly visits for centre stands. A predefined test process exists here for every new development.

MG: There are checklists to follow for all attachments. For example, we always check the ground clearance of the motorcycle when our accessory parts are installed.

AB: Consideration has to be taken of the ergonomic aspects of the average biker. Tests to assess leg room or even unrestricted operation of the brake and clutch pedal are therefore mandatory and must be ensured.

#### 10. How do prototypes become series parts?

AB: First and foremost, the finished prototype is captured digitally in its entirety. During the gauge construction that follows, minor optimisations are still performed as necessary. To then manufacture a 0 series (a low quantity of 10 parts is manufactured under real-life manufacturing conditions). Series production can only start once these parts have been released. In parallel, the installation instructions are created and required components such as screws, washers and distances are checked for availability and ordered directly with long lead times.

#### 11. And when do you come in, Anatoli?

AQ: My job is to make the required manufacturing gauges for an available sample. Nothing more and nothing less!

NA: I can describe his job a bit more precisely here (laughs). His role acts as the link in the chain between development and production. Anatoli makes sure that the gauges for production are manufactured properly and accompanies the first series production. What makes his experience so valuable is that he knows exactly what is needed in production and where potential challenges may lie.

## Appreciation creates value.

It takes a lot of motivated people all pulling together to be able to offer you the best possible product. The positive attitude of each individual employee is made up of passion for everyday work paired with enthusiasm for motorcycles, stemming from a meaningful and important role in the company.

This increases mutual appreciation among employees for the work they do every day. Because depending on the department and tasks in the company, each employee has their own individual abilities and expertise which comes from prior knowledge or is picked up on the job, day after day, year after year. This experience is reflected in the final product. Over the years, this has resulted in a tight-knit team.

This policy of team spirit is beneficial for a positive working climate and good vibes in the office or workshop. Respectful cooperation and open, eye-level communication lay the foundation for manufacturing products that consumers want. We are always on the lookout for capable hands and clever minds to join our team.

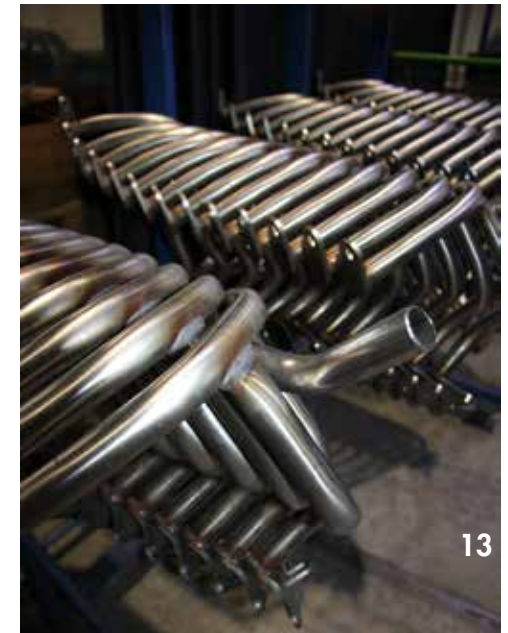

# PASSION-DRIVEN DEVELOPMENT – QUESTIONS TO DIFFERENT MEMBERS OF THE TEAM

**12. In the age of digitalisation, all data for a new prototype is definitely saved to the server, right?**

*MG: Thanks to our new ERP system, which we took live at the start of the year, lots of relevant data in the development process is entered and stored directly – but not everything! The basis for manufacturing our metal parts has always been the sample part and associated gauge, without which nothing would get done. Only in this way can we perform series production.*

*MT: We digitalise all relevant data required for later series production! Whether bending data, tube lengths, the shape of the laser-cut parts, etc.*

*AB: But we always keep the very important things in our heads. Also to protect against hackers (grins).*

**13. What is the finishing step in the development of this kind of engine guard?**

*AB: The trial attachment of the 0 series.*

**14. Who creates the product images that can be found in the online shop and in the installation instructions?**

*MG: That's where our Marketing department comes in. But if urgent, sometimes*

*the "Junior Boss" takes care of that personally. He's well-known internally for his good photography skills and always gives it his all (winks).*

*PE: Fun aside! The girls from Marketing know by now what matters. The pictures have to look good and be informative. In addition, things have to work swiftly so that we can start with the publications as quickly as possible.*

**15. What's the secret behind products in the production department still being produced with perfect precision, even when already over 40 years old?**

*AQ: It's all about carefully handling and regularly maintaining the gauges. Before each series production, the gauges and samples are checked to prevent anything from going wrong in production.*

*AB: It also comes down to the solid construction of the gauges, which are almost indestructible.*

**16. And finally, one more personal question: which motorcycle on your lifting platform recently were you drawn to most and why?**

*AB: The Honda DAX, it could stand right next to my desk. Small, simple and fast*

*as lightning – and we do have some beautiful accessories in our range (laughs and smiles).*

*MG: The KTM 890 SMT, now that's a bike I'd like to have for a week or two.*

*MT: The Yamaha Ténéré 700. I'm a big fan of the machine's sleek, sporty Dakar Rally design.*

*AQ: A Harley! Perhaps a Forty Eight Sportster – it has a really cool sound and doesn't stand too high. It's also ideal for people who aren't 2 metres tall or want some lowering.*

*MD: A BMW S1000R, from the latest generation – nobody needs more performance and less windscreen than that.*

*NA: If we're talking about something new, then the Triumph Thruxton 1200 FE (Final Edition) in British Racing Green with a metallic effect and those gorgeous, golden highlight lines. A feast for the eyes and almost too beautiful to ride.*



# TABLE OF CONTENTS • LUGGAGE

**XCEED 20**



**XPLORER 28**



**SIDE AND TOP CASES**

**ALU STANDARD 38**



**GOBI 44**



**JOURNEY 50**



**JUNIOR 56**



**JUNIOR FLASH 56**



**SIDE AND TOP CASES**

**XTRAVEL 82**



**JOURNEY TOPCASE 64**



**ORBIT 71**

**SIDE AND TOP CASES**

**HEPCO&BECKER**

# TABLE OF CONTENTS • LUGGAGE

**XCORE 74**



**ORBIT 78**



**STRAYKER 80**



**XTRAVEL 82**



**ROYSTER 86**



**STREET 90**



## C-BOW LUGGAGE

**DRYBRID 95**



**XTRAVEL XL/M 92/94**



**ROYSTER 96**



**STREET 106**



**SPORT STAR 101**



**LEGACY 102**



**NEW**

## REAR BAGS

**EPIC 106**



**STREET 112**



**ROYSTER 110**



**LEGACY 105**



**V1 117**



**TANK BAGS**

**TANK BAGS**

**TANK GUARD BAG**

**HEPCO&BECKER**



# TABLE OF CONTENTS • LUGGAGE

**LEGACY** 120/103

**BUFFALO / LIBERTY** 131

**LEGACY** 132



**C-BOW LUGGAGE**

**TOOL BAGS**

**RUGGED** 122

**BUFFALO / BUFFALO CUSTOM** 124

**IVORY** 127

**LIBERTY** 128

**NEVADA** 130



**LEATHER BAGS**

**RUGGED** 134

**BUFFALO / BUFFALO CUSTOM** 136

**LIBERTY** 138

**LEGACY** 133



**LEATHER REAR BAGS**

**HEPCO&BECKER**

# TABLE OF CONTENTS • CARRIER

## CARRIER SYSTEMS FOR SIDE CASES AND SIDE BAGS



LOCK IT SIDE CARRIER 142



SIDE/COMPLETE CARRIER 143



C-BOW HOLDER BLACK 150



C-BOW HOLDER CHROME 151



LEATHER BAG HOLDER TUBE TYPE 152

## CARRIER SYSTEMS FOR TOP CASES



EASYPACK 144



ALURACK 145



REAR RACKS TUBE TYPE 146



UNIVERSAL PARTS 156



RUGGED CUTOUT 153

## CUTOUT HOLDER

## CARRIER SYSTEMS FOR SOFT BAGS



MINIRACK 148



ENLARGEMENT 149



SPORTRACK 157



SISSYBAR 160



SOLORACK 161

# TABLE OF CONTENTS • PROTECTION / ACCESSORIES

## PROTECTION BARS



PROTECTION BARS 162  
BARS STAINLESS STEEL 168



ENGINE GUARDS CHROME 167

**NEW**



SLIDEPACK 166



REAR/FRONT GUARDS 169



RAILING/HANDLE BAR 170

## PROTECTION



HANDLE GUARDS 171



SKID PLATES 172



HEADLIGHT GRILLES 173



CENTER STANDS 176



SIDE STAND ENLARGEMENTS 177

## ACCESSORIES



FENDER GUARD 178



TWINLIGHTS 179

**NEW**



NOVA LED FLOORER 175



CANISTER SET 180

## TANKRINGS



LOCK IT TANKRING 154

**HEPCO & BECKER**



**BIKE MODELS 181**

# XCEED

Exceeding limits



The XCEED sets new standards in the field of aluminium cases. The unmistakable appearance paired with the experience of more than 40 years of manufacturing motorcycle cases are the basis of this new unique case. A unique hydro-forming manufacturing process leads to excellent surfaces. The titan case is additionally provided with an anodized coating, which not only increases the corrosion protection and scratch resistance but also creates a beautiful and haptic surface.

The black version of the Xceed is powder-coated. The combination of high-quality aluminium and impact-resistant plastic creates an elegant, timeless case that is light and handy.

With great attention to detail, the design takes up contemporary forms and lines. This distinguishes it from other aluminium cases. No matter on which motorbike - this case is worth seeing.

# XCEED

Robust bottom tray  
Matt and glossy surfaces



Lock with integrated hinge  
Comfortable carrying handle on both sides



Logo embedded in the lid



Anodised aluminium sheet with logo embossing and high-impact resistant plastic parts at high stressed areas



Integrated waterproof seal  
Special feature: Luggage net integrated in the lid



High-quality rivets and additional bonding guarantee stability

# XCEED Side case

Exceeding limits



**Xceed Silver**  
**Left case**

Item-no. 610222 00 09

**Right case**

Item-no. 610223 00 09



**Xceed Black**  
**Left case**

Item-no. 610222 00 11

**Right case**

Item-no. 610223 00 11



**Xceed Titan**  
**Left case**

Item-no. 610222 00 00

**Right case**

Item-no. 610223 00 00



**Xceed Jet black**  
**Left case**

Item-no. 610222 00 01

**Right case**

Item-no. 610223 00 01

# XCEED Side case



## XCEED Side case

- Made of 1.5 mm thick aluminum plates, anodized or black coated
- Impact-resistant plastic molding - absorbs impacts and ground contact
- Lid opens from both sides and is completely removable for easy loading
- Stable, easy-to-use locks, both sides, integrated carrying handles
- Absolutely waterproof due to the glued-in special seal
- Case and top case available with simultaneous locking (please specify when ordering).
- Luggage net integrated in the lid
- Comprehensive range of accessories available
- Functional lid holder
- Incl. key and cylinder



Xceed silver

## INFO

**Case Xceed**  
Weight: 5,2 kg  
Capacity: 38 Litres  
Load: 10 kg each case

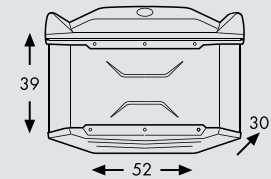

**Side case fits with**



**Side case carrier / Complete carrier**



# XCEED Top case



**Xceed Top case silver**  
Item-no. 610224 00 09



**Xceed Top case black**  
Item-no. 610224 00 11



**Xceed Top case Titan**  
Item-no. 610224 00 00



**Xceed Top case Jet black**  
Item-no. 610224 00 01



# XCEED Top case



## XCEED Top case

- Made of 1.5 mm thick aluminum plates, anodized or black coated
- Impact-resistant plastic molding - absorbs impacts and ground contact
- Lid opens from both sides and is completely removable for easy loading
- Stable, easy-to-use locks, both sides, integrated carrying handles
- Absolutely waterproof due to the glued-in special seal
- Case and top case available with simultaneous locking (please specify when ordering).
- Luggage net integrated in the lid
- Comprehensive range of accessories available
- Functional lid holder
- Incl. key and cylinder
- Top case: space for one helmet

INFO

### Top case Xceed

Weight: 4,8 kg  
Capacity: 45 Litres  
Load: 5 kg

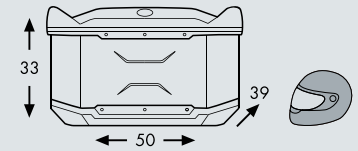

### Top case fits with



Easyrack / Alurack / Rear rack tube type



Xceed TC silver



# XCEED ACCESSORIES

## Inner bag



The Xceed inner bag is perfectly adapted to the case shape. Loading is easier because the inner bag can be packed in advance. And at the end of the tour, all you have to do is take the inner bag with you. Equipped with 2-way zipper and adjustable shoulder strap. A useful supplement for everyday use.

**Inner bag Xceed side case**  
Item-no. 700523

**Inner bag Xceed top case**  
Item-no. 700524

## Carrying handle



The carrying handle has an ergonomically shaped hand grip and is fastened to the case with the lashing eyes.

**for side case**  
Item-no. 740016

## Shoulder strap for case/top case



Can only be used in combination with carrying handle for case/top case

**Shoulder strap**  
Item-no. 700401

## Top bag



The Xceed top bag is ideal for storing more luggage. With a volume of 11 litres and the all-around zipper, additional storage space is created. Useful and simple extension of the cases for additional luggage. Recommended for longer journeys. The inner bag is waterproof.  
Dimension: 12x45x26cm

**Top bag Xceed Case**  
Item-no. 640006 00 01



With waterproof inner liner

## Back rest



A backrest on the top case keeps your passenger comfortable even on long trips. Made of soft black polyurethane and designed for optimal shock absorption.

**for Xceed top case**  
Item-no. 700322

# XCEED ACCESSORIES

## Additional kit for Xceed side cases



Additional kit for Xceed side cases for mounting universal holder, set for water bottle & water canister

**Additional kit Xceed**  
Item-no. 710127

## Universal accessory holder



Fastened to the case exterior. Lets you carry your accessories along with you, fastened to the case with straps (not included).

**Universal holder\***  
Item-no. 740003

## 2-litres cannister



A useful addition to the aluminum cases or top cases. The small plastic cannister holds about 2 litres of water. Complete set with all parts. Diameter of the opening: 29mm Incl. universal holder.

**Cannister Set\***  
Item-no. 740005

**\*NOTE:**  
Mounting on side cases only possible with the additional kit for Xceed. Holes must be drilled in the case/top case. Sealing washers included.

## Bracket set for water bottles



**Bracket set for water bottles\***  
Incl. universal holder  
Item-no. 740004

**Water bottle**  
0,6 Litres  
Item-no. 740015

## SPARE PARTS XCEED



## Description

## Item-no.

- |   |                    |
|---|--------------------|
| 1. Lid lock without cylinder for case/top case* | 710115 00 01       |
| 2. Fixing lock with cylinder for top case*      | 710114 00 01-xxx** |
| 3. Cylinder with key for Pos.1 and 2.*          | 710109             |
| 4. Key*   | 710110             |
| 5. Sealing for Xceed case                       | 710087             |
| 5. Sealing for Xceed top case                   | 710145             |
| 6. Lid holder for Xceed case/ top case          | 710097             |
| 7. Logo ø32mm                                   | 710095             |
| 8. Emblem Xceed chrome                          | 710086 00 02       |
| 8. Emblem Xceed black                           | 710086 00 01       |
| 9. Luggage net for Xceed top case               | 710083             |
| 9. Luggage net for Xceed case                   | 710082             |

\*Indicate the key number

\*\*Example: Desired key number: 140 - Order number: 710112 00 01-140 01-140

# XPLORER

The top class combining aluminium and plastic



A modern yet contemporary design of an extremely robust combination of anodized aluminum plate and highly impact-resistant plastic molding. This merging of design and functionality matches the modern spirit of many motorcycles. With its 1.5 mm thick anodized aluminum plate and tough plastic parts, this case absorbs impact and vibration with special ease. The anodized or powder-coated aluminum effectively prevents unsightly aluminum wear. The Xplorer has a high-quality surface structure. The lid opens to a 90° angle! This case is guaranteed watertight.

# XPLORER

High-quality connection between sheet metal and frame thanks to adhesive-rivet connection



Case and top case have several integrated slots for belt fastening e. g. for a matching top bag, which is attached to the case lid. High quality logo embossing

Waterproof thanks to integrated lid seal and raised case frame

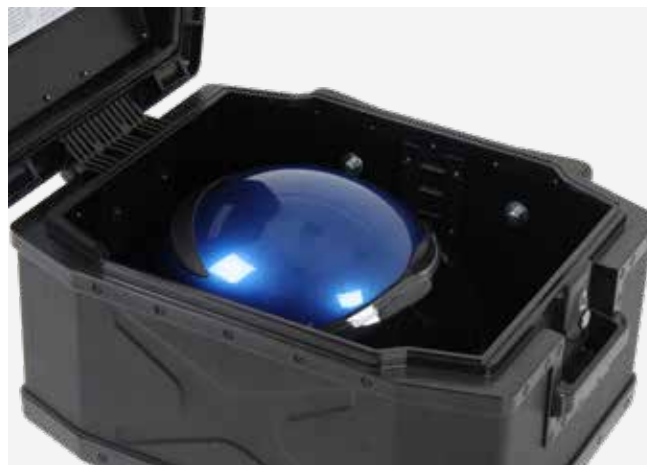

Xplorer top case and sicecase 40 have room for one helmet and more...

Easy to use, stable metal locks (Fixing and lid lock)



Ergonomic handles on both sides coupled with integrated hinges

# XPLORER Side case



**Xplorer 30 silver**  
**Left case**  
Item-no. 610208 00 00  
**Right case**  
Item-no. 610209 00 00



**Xplorer 40 silver**  
**Left case**  
Item-no. 610210 00 00  
**Right case**  
Item-no. 610211 00 00



**Xplorer 30 black**  
**Left case**  
Item-no. 610213 00 01  
**Right case**  
Item-no. 610214 00 01



**Xplorer 40 black**  
**Left case**  
Item-no. 610215 00 01  
**Right case**  
Item-no. 610216 00 01

# XPLORER Side case

## Xplorer

### XPLORER Side case

- Made of 1.5 mm thick plate aluminum, silver anodized or black coated
- Impact-resistant plastic molding - absorbs impacts
- Secure metal locks, integrated carrying handles
- Top loader – cover folds up 90°
- Absolutely watertight, no aluminum wear
- Side and top case available with simultaneous locking (please specify when ordering).
- Comprehensive range of accessories available
- Incl. key and cylinder
- In two sizes (30/40 Litres) - 40 Litres with space for one helmet



Xplorer 40

### INFO

#### Case Xplorer 30

Weight: 4,4 kg  
Capacity: 33 Litres  
Load: 10 kg each case

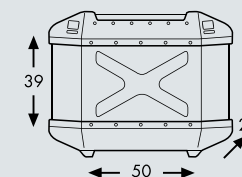

#### Case Xplorer 40

Weight: 4,9 kg  
Capacity: 42 Litres  
Load: 10 kg each case

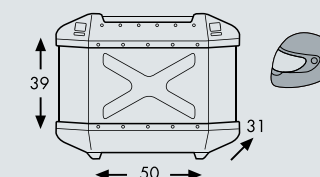

Fits with



Side case carrier / Complete carrier



# XPLORER Top case



**Xplorer 45 silver**  
Item-no. 610212 00 00



**Xplorer 60 silver**  
Item-no. 610225 00 00



**Xplorer 45 black**  
Item-no. 610217 00 01



**Xplorer 60 black**  
Item-no. 610225 00 01



# XPLORER Top case

# Xplorer

## XPLORER Top case

- Made of 1.5 mm thick plate aluminum, silver anodized or black coated
- Impact-resistant plastic molding - absorbs impacts
- Secure metal locks, integrated carrying handles
- Absolutely watertight, no aluminum wear
- Side and top case available with simultaneous locking (please specify when ordering).
- Comprehensive range of accessories available
- Incl. key and cylinder
- TC45: Storage space for a helmet
- TC60: Storage space for two helmets



Xplorer TC 45 silver

### Top case Xplorer 45

Weight: 4,8 kg  
Capacity: 45 Litres  
Load: 5 kg

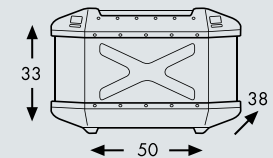

### Top case Xplorer 60

Weight: 6,1 kg  
Capacity: 58 Litres  
Load: 10 kg

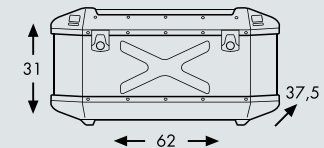

### Fits with



Easyrack / Alurack / Rear rack tube type



# XPLORER CUTOUT SET

Set of cases and side carrier - high volume - less width - more value

# Xplorer Cutout

This exclusive set for assorted models consists of a model specific stainless steel side carrier and two Xplorer aluminum cases. Due to its recessed 37 liter Xplorer case on one side the case is close to the bike.

On the other side is a special 40 liter Xplorer case. With this combination the width is reduced and the bike looks symmetrical from the back. It does not interfere with the stability of the bike due to the center of gravity being so close. The cases are made of shock resistant plastic molding and anodized aluminum sheets. The black version is powder coated additionally.

The side carrier is made of 2mm strong stainless steel pipe with 16mm in diameter. The surface is electro polished. The system is light and stable, perfectly for offroad use.



**Xplorer Cutout Set**  
Item-no. see model list

**Xplorer Cutout Set black**  
Item-no. see model list

Also as a black version with powder coated surface



**Xplorer Cutout 37 silver**  
Weight: 4,6 kg; Capacity 37 Liters  
Dimensions WxHxD:  
48 x 38 x 22/31 cm  
Load: 10 kg each case

**Xplorer 40 silver**  
Weight: 4,9 kg; Capacity 42 Liters  
Dimensions WxHxD:  
50 x 39 x 31 cm  
Load: 10 kg each case  
Space for one helmet

**Side carrier - firmly bolted**  
Surface-blasted, electro-polished side carrier

# XPLORER

## XPLORER CUTOUT SETS - available for:

APRILIA Tuareg 660 (2022-)  
 BMW F 650/700/750/800/850 GS  
 BMW R 1250 GS LC (2018-)  
 BMW R 1200 GS (2004-)  
 BMW R 1200 GS LC (2013-2017)  
 BMW R 1200 GS Adventure (2014-)  
 DUCATI DesertX (2022-)  
 HONDA CRF 1000 Africa Twin / Adventure Sports  
 HONDA CRF 1100 Africa Twin / Adventure Sports  
 HUSQVARNA Norden 901 (2022-)  
 KTM 1050 / 1190 Adventure/R  
 KTM Super Adventure 1290  
 KTM 790 / 890 Adventure/R  
 SUZUKI V-Strom 650 ABS  
 TRIUMPH Tiger 800/XC/X/CX/A/XR/XRX/T  
 YAMAHA Ténéré 700

### Features case:

- On muffler side with recessed 37-liter Xplorer case
- High-impact plastic and anodized aluminum sheet
- With keys and cylinder locks
- Optional accessories
- Optional luggage space added with top bag

### Features carrier:

- A weather-resistant, firmly fastened Stainless steel side carrier that fits for any adventure
- Surface-blasted, electro-polished metal tubes
- About one meter total width, depending on model
- Includes clear installation instructions

## SPARE PARTS XPLORER

### Description

### Item-no.

1. Fixing lock for case	710113 00 01-xxx**
1. Fixing lock top case	710112 00 01-xxx*
2. Lid lock	710114 00 01-xxx*
3. Cylinder with key, for 1. and 2.*	710109
4. Key*	710110
5. Sealing for Xplorer 30	710005
5. Sealing for Xplorer 40/Xplorer Cutout 37/40	710004
5. Sealing for Xplorer Top case	710003
6. Fixing clamp	710119

\*Indicate the key number

\*\*Example: Desired key number: 140 - Order number: 710112 00 01-140 01-140



## Tool Box



The robust, completely waterproof toolbox, made from shock-resistant plastic, excellently complements the side case carrying system, and is ideally connected between the side case and the back of the bike. By fixing it on the opposite side to the muffler, the empty space is used in the best possible way and it creates additional storage room. With a length of 29cm and a width of 8cm, both tools and replacement parts can be accommodated whilst saving space. The toolbox has a quick-open screw top. The universal version can be attached in other positions too.

# XPLORER ACCESSORIES

## Inner bag



Easier loading before and at the end of the ride, there's no need to remove the whole case – just the inner bag. Made of hard-wearing black fabric with 2-way zipper and adjustable carrying strap.

**Inner bag for Xplorer 40 / Cutout 40**  
Item-no. 700514

**Inner bag for Xplorer 30**  
Item-no. 700513

**Inner bag for Xplorer Cutout 37**  
Item-no. 700520

**Inner bag Xplorer top case 45**  
Item-no. 700515

**Inner bag Xplorer top case 60**  
Item-no. 700525

## Top bag for cases



The bags offer additional storage space on the case lids and are easily fastened to the case.

**for Xplorer 40 / Cutout 37**  
Item-no. 640005 00 01

**for Xplorer 30**  
Item-no. 640004 00 01

## Tool roll



With pockets for hand tools. Without tools.

**Tool roll**  
Item-no. 640013 00 01

## Security kit for expeditions



**for Xplorer 30/40**  
Item-no. 750002

**for Xplorer Cutout 37/40**  
Item-no. 750003

On extreme expeditions, it makes sense to attach the case to its carrier to deter theft. For this, the security kit is the right option.

A special bracket on the exterior hooks behind the carrier.

NOTE: This requires holes to be drilled in the case.

## Back rest



A backrest on the top case keeps your passenger comfortable even on long trips. Made of soft black polyurethane and designed for optimal shock absorption.

**Backrest**  
Item-no. 700315

## Universal accessory holder



Fastened to the case exterior. Lets you carry your accessories along with you, fastened to the case with straps (not included).

NOTE: This requires holes to be drilled in the case/top case.

**Universal holder\***  
Item-no. 740003

# XPLORER ACCESSORIES

## Railing



TC 45



TC 60/Xplorer 30/40

Extra luggage can be carried on this rail or works as a transport aid. The rail is of steel tubing and protected with a plastic coating.

for Xplorer top case 45/60  
Item-no.  
610093 00 01  
610093 00 09

for Xplorer 30 Case  
Item-no.  
610098 00 01

for Xplorer 40/Cutout 40  
Item-no.  
610099 00 01

## Carrying handle



The carrying handle has an ergonomically shaped hand grip and is fastened to the case with the lashing eyes.

for top case 45  
Item-no. 740014

for side case  
Item-no. 740009

## Shoulder strap for case/top case



The shoulder strap (can only be used in combination with carrying handle for case/top case) offers the possibility to transport the case and still have your hands free.

Shoulder strap  
Item-no. 700401

## 2-litres cannister



A useful addition to the aluminum cases or top cases. The small plastic cannister holds about 2 litres of water. Complete set with all parts. Diameter of the opening: 29mm  
NOTE: This requires holes to be drilled in the case



Cannister Set\*  
Item-no. 740005

\*NOTE:  
Mounting on side cases only possible with the additional kit for Xceed.  
Holes must be drilled in the case/top case. Sealing washers included.

## Bracket set for water bottles

Brackets for aluminum water bottles are a useful addition to the aluminum cases. Bottle not included. NOTE: This requires holes to be drilled in the case

Bracket set for\*  
water bottles  
Item-no. 740004

Water bottle  
0,6 Litres  
Item-no. 740015



# ALU STANDARD

For everyday use and extreme situations



With the Alu Standard collection, we have created models that also stand up to extreme conditions with no trouble at all. The 1.5 mm thick, smooth, highly durable aluminum alloy helped give the collection its name.

With their right-angled shape, Alu Standard side cases provide spacious, practical storage space with no protruding corners or edges and are easy to load from above. The foam lid seal keeps the content of the case or top case dry. The different widths side cases can be combined for Enduro bikes.

Especially recommended for side carriers that have different mounting widths due to the high exhaust system position typical of Enduros. The Enduro set can eliminate this asymmetry.

# ALU STANDARD

Embossing for edge protection and to increase stability and give the cases an unmistakable character



Case frame very robust and resistant due to manufacturing process

Watertight lid seal  
Metal reinforcement below chrome rail



Steel support frame, chrome-plated with metal lock

Standard chrome rail  
Stable metal lid lock



Top loader

# ALU STANDARD

For everyday use and extreme situations



## Alu Standard 35

Left case

Item-no. 610074 00 00

Right case

Item-no. 610075 00 00



## Alu Standard 40

Left case

Item-no. 610076 00 00

Right case

Item-no. 610077 00 00



Topcase

## Alu Standard 35

Item-no. 610073 00 00



# ALU STANDARD

## ALU STANDARD Top case

- Robust 1.5 mm aluminum shell material with edge and base profile for stability
- Watertight, thanks to special foam seal
- Carrying handle on lid, stainless steel lid hinges
- Comprehensive range of accessories
- Incl. key and cylinder

## ALU STANDARD Side case

- Robust 1.5 mm aluminum shell material with edge and base profile for additional stability
- Watertight, thanks to special foam seal
- Top loading, carrying handle in the lid area, stainless steel hinges on lid
- Case and top case available with simultaneous locking (please specify when ordering).
- Cases can be combined as an Enduro set
- Incl. key and cylinder



Alu Standard 40



INFO

**Side case  
Alu Standard 35**  
Weight: 5,9 kg  
Capacity: 36 Litres  
Load: 10 kg each case

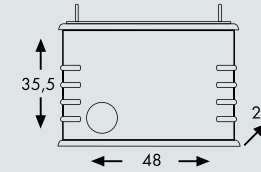

**Side case  
Alu Standard 40**  
Weight: 6,4 kg  
Capacity: 42 Litres  
Load: 10 kg each case

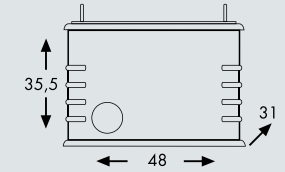

Fits with



**Side case carrier / Complete carrier**

**Top case Alu Standard 35**  
Weight: 5,2 kg • Capacity: 35 Litres  
Load: 5 kg

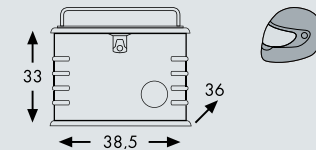

Fits with



**Alurack / Rear rack tube type**

**For the use with an Aluracks we recommend the optional special bracket - see Accessories**

# ALU STANDARD ACCESSORIES

## Inner bag



Easier loading before and at the end of the ride, there's no need to remove the whole case – just the inner bag. Made of hard-wearing black fabric with 2-way zipper and adjustable carrying strap.

for Alu Standard 40 side case  
Item-no. 700509

for Alu Standard 35 side case  
Item-no. 700508

for Alu Standard 35 top case  
Item-no. 700510

## Security kit for expeditions



Security kit  
Item-no. 750007

On extreme expeditions, it makes sense to attach the case to its carrier to deter theft. For this, the security kit is the right option. A special bracket on the exterior hooks behind the carrier.  
NOTE: This requires holes to be drilled in the case.

## Back rest



A backrest on the top case keeps your passenger comfortable even on long trips. Made of soft black polyurethane and designed for optimal shock absorption.

Backrest  
Item-no. 700315 black

## 2-litres cannister



Cannister Set  
Item-no. 740005

A useful addition to the aluminum cases or top cases. The small plastic cannister holds about 2 litres of water. Complete set with all parts. Diameter of the opening: 29mm  
NOTE: This requires holes to be drilled in the case

## Bracket set for water bottles

Brackets for aluminum water bottles are a useful addition to the aluminum cases. Bottle not included.

NOTE: This requires holes to be drilled in the case

Bracket set for  
water bottles  
Item-no. 740004

Water bottle  
0,6 Litres  
Item-no. 740015



# ALU STANDARD ACCESSORIES

## Reflection strips



Self-adhesive for cases and topcases in red and white. Improves the perception in the dark or twilight. 1m fixed length, 55mm wide.

Item-no. 710234 00 03 white  
Item-no. 710234 00 04 red

## Spare Parts Alu Standard Side Case



## Description

1. Fixing lock with cylinder, black\*
1. Fixing lock with cylinder, silver\*
2. Lid lock with cylinder, black\*
2. Lid lock with cylinder, silver\*
3. Cylinder with key for Pos.1 and 2.\*
4. Key\*
5. Railing for Alu Standard 35
5. Railing for Alu Standard 40
6. Railing reinforcement for Alu Standard 35
6. Railing reinforcement for Alu Standard 40
7. Lid counterpart
8. Spacer for lid
9. Holder left with Fixing lock
9. Holder right with Fixing lock

## Item-no.

- 710113 00 01-xxx\*\*
- 710113 00 09-xxx\*\*
- 710114 00 01-xxx\*\*
- 710114 00 09-xxx\*\*
- 710109
- 710110
- 710063
- 710065
- 710064
- 710066
- 710070
- 710071
- 710073
- 710074

## Special to pcase bracket



For use on an Alurack, we recommend our special top case bracket for optimal fastening.

Bracket for Alurack  
Item-no. 700007351 silver  
Item-no. 700007350 black

## Spare Parts Alu Standard Top Case

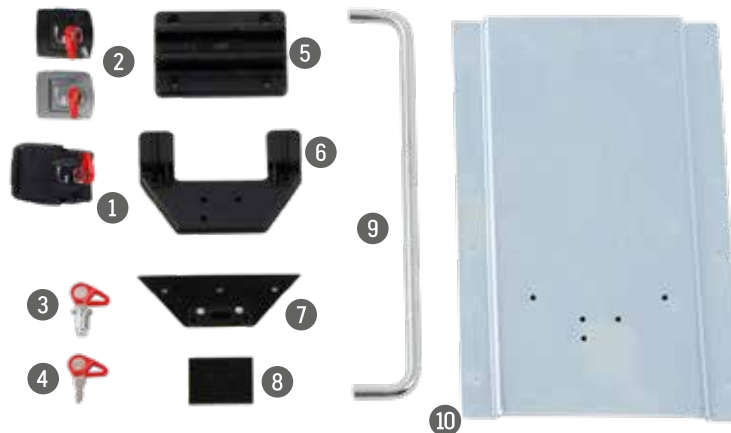

## Description

1. Fixing lock with cylinder, black\*
2. Lid lock with cylinder, black\*
2. Lid lock with cylinder, silver\*
3. Cylinder with key for Pos.1 and 2.\*
4. Key\*
5. Locating moulding
6. Fixing clamp
7. Lid counterpart
8. Spacer for lid
9. Railing
10. Bottom plate

## Item-no.

- 710112 00 01-xxx\*\*
- 710114 00 01-xxx\*\*
- 710114 00 09-xxx\*\*
- 710109
- 710110
- 710072
- 710119
- 710070
- 710071
- 710067
- 710069

\*Indicate the key number

\*\*Example: Desired key number: 140

- Order number: 710112 00 01-140 01-140/ 710112 00 01-140 09-140

# GOBI

The answer to every question



If you want to go on new trails, you have to leave the old paths. After 25 years of motorcycle case development and production, the GOBI is the answer to every question. The goal was to create a real alternative to the ordinary aluminum case. And with the GOBI series, we've succeeded! If an aluminum case drops, it usually gets damaged. That reduces its functionality. The GOBI is made of highly impact-resistant plastic, colored through and through. Its special shell is extremely resistant and watertight, and it absorbs shocks and unintentional contact with the ground. GOBI gets its stiffness and stability from its double-wall construction. This also allows over 3.5 quarts of liquid to be stowed in each side compartment.

# GOBI

Side case and top case made of robust and impact-resistant plastic, double-walled. Railing as standard on Topcase.



Watertight thanks to a special seal



Stable metal mounting lock, incl. key and cylinder



Sturdy metal lid locks including key and cylinder  
Stability and design due to ribbed structure



Integrated ergonomic carrying handle  
and rubber hinge cover

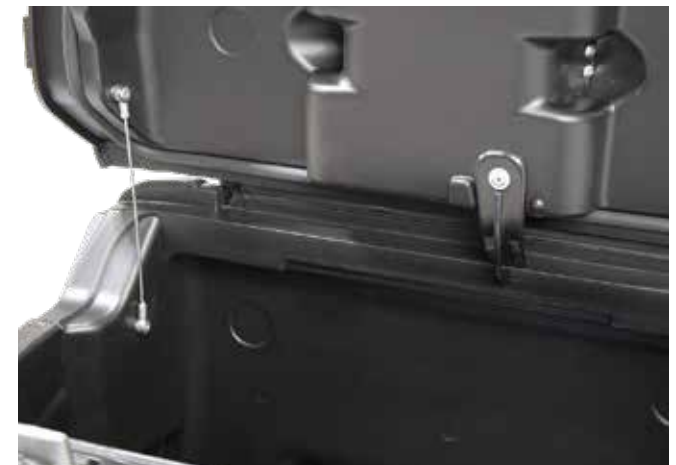

Lid locking device and lid holder, standard

# GOBI

The answer to every question



**Gobi black edition**  
- with mounted luggage brackets  
Item-no. 610288 00 01



**Gobi black**  
Item-no. 610083 00 01



**Topcase  
Gobi black edition**  
Item-no. 610289 00 01



**Topcase  
Gobi black**  
Item-no. 610084 00 01

## GOBI Top case

- Special double-walled shell, watertight thanks to a special seal
- Made of highly impact-resistant solid plastic
- Standard metal railing
- Extremely rugged metal locks, ergonomic handle
- Case and top case available with simultaneous locking (please specify when ordering).
- Comprehensive range of accessories
- Incl. key and cylinder

## GOBI Side case

- The top-loading reference for extreme riding
- Special double-walled shell, watertight thanks to a special seal
- Made of highly impact-resistant solid plastic
- Side case carries over 3.5 quarts of liquid between the shells
- Extremely rugged metal locks, ergonomic handle
- Case and top case available with simultaneous locking (please specify when ordering).
- Comprehensive range of accessories
- Incl. key and cylinder



Gobi black edition

## INFO

### Side case Gobi

Weight: 6,0 kg  
Capacity: 31 Litres  
Load: 10 kg/Case

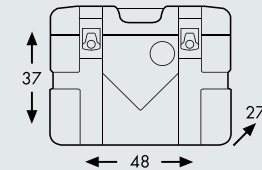

### Fits with



Side case carrier / Complete carrier

### Top case Gobi

Weight: 6,0 kg  
Capacity: 38 Litres  
Load: 5 kg

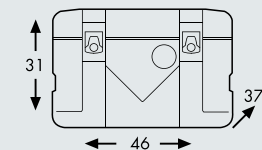

### Fits with



Easyrack / Alurack / Rear rack tube type

# GOBI ACCESSORIES

## Inner bag



Easier loading before and at the end of the ride, there's no need to remove the whole case – just the inner bag. Made of hard-wearing black fabric with 2-way zipper and adjustable carrying strap.

**For Gobi Side case**  
**Item-no. 700508**

**For Gobi top case**  
**Item-no. 700511**

## Security kit for expeditions



**Security kit**  
**Item-no. 750008**

On extreme expeditions, it makes sense to attach the case to its carrier to deter theft. A special bracket on the exterior hooks behind the luggage carrier.  
NOTE: This requires holes to be drilled in the case.

## Back rest



A backrest on the top case keeps your passenger comfortable even on long trips. Made of soft black polyurethane and designed for optimal shock absorption.

**Backrest**  
**Item-no. 700312**

## Luggage brackets



Sensible accessory for GOBI cases. Allow soft luggage to be strapped to the case (straps not included) Standard equipment at the Gobi black edition cases.

**Luggage brackets**  
**Item-no. 700149**

## Water tap for case



The GOBI case is made of two honeycombed shells, which provides empty space to hold more than 3.5 quarts between the inner and outer case shell. This can be made accessible with a water tap.



Filling opening

**Water tap**  
**Item-no. 700148**



# SPARE PARTS GOBI SIDE CASE AND TOP CASE

## Spare Parts Gobi Side case



## Description

1. Fixing lock with cylinder, grey\*
2. Lid lock with cylinder, grey\*
3. Cylinder with key, for Pos1. and 2.\*
4. Key\*
5. Hinge cover black
6. Hinge strip black
6. Hinge strip grey
7. Lid plate inside
8. Lid plate outside black
8. Lid plate outside grey
9. Rubber
10. Rubber buffer
11. Lid locking device
12. Wire lid holder
13. Sealing
14. Logo ø50mm

## Item-no.

- 710111 00 09-xxx\*\*
- 710114 00 09-xxx\*\*
- 710109
- 710110
- 710062 00 01
- 710058 00 01
- 710058 00 09
- 710059
- 710060
- 710061
- 710057
- 710056
- 710054
- 710053
- 710055
- 710000

## Spare Parts Gobi top case



## Description

1. Fixing lock, black with cylinder\*
2. Lid lock with cylinder, grey\*
3. Cylinder with key, for Pos1. and 2.\*
4. Key\*
5. Front railing (lock side) grey
6. Rear railing grey
7. Fixing clamp
8. Locating moulding
9. Wire lid holder
10. Sealing
11. Logo ø50mm

## Item-no.

- 710112 00 01-xxx\*\*
- 710114 00 09-xxx\*\*
- 710109
- 710110
- 710051
- 710052
- 710119
- 710117
- 710053
- 710068
- 710000

\*Indicate the key number

\*\*Example: Desired key number: 140

- Order number: 710112 00 01-140 01-140 /710112 00 01-140 09-140

# JOURNEY

Aerodynamic design perfected



A timeless classic: Modern design combined with consistent quality and ingenious details. No matter which angle you look at your motorcycle from, the JOURNEY series' aerodynamic makes for a sweeping appearance and a safe ride. Plus, the JOURNEY series provides enough storage space for long trips and stays watertight thanks to special seals. The unique integrated bumper strip protects the case during minor jostling and impacts. The case's shell is made of impact-resistant, double-walled plastic. The removable covers can optionally be painted to match the bike color. This product has been proven over years.

# JOURNEY

3D logo. Cover can be removed and painted to match bike color  
Picture shows the Journey 42 matte white.



Exchangeable scuff and bumper strip

High quality grained plastic surface  
Cover smooth and painted; the black gloss variant is below.



Space for one helmet in side case and top case

Stable metal-lock incl. key and cylinder



2 tension belts in each case shell  
Waterproof double seal

## JOURNEY Side case



**Journey 42 silver**  
Item-no. 610080 00 01



**Journey 42 recon**  
Item-no. 610280 00 04



**Journey 42 black**  
Item-no. 610280 00 11



**Journey 42 white**  
Item-no. 610080 00 03

# JOURNEY Side case

## JOURNEY Side case

- Covers can be removed and painted to match bike color
- Watertight thanks to special seal
- Integrated bumper strip provides impact protection
- Case shell made of highly impact-resistant plastic
- Case and top case available with simultaneous locking (please specify when ordering).
- Comprehensive range of accessories
- Incl. key and cylinder
- Space for one helmet



Journey 42 black

## INFO

### Side case Journey 42

Weight: 3,8 kg

Capacity: 40 Litres

Load: 10 kg each case

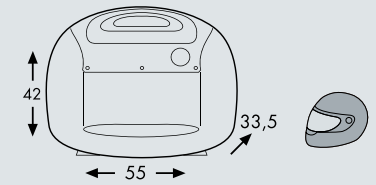

Fits with



Side case carrier / Complete carrier

Spare parts see page 63

Inner bag for side case and top case  
Item-no. 700503



# JOURNEY Top case



**Journey 42 silver**  
Item-no. 610085 00 01



**Journey 42 recon**  
Item-no. 610285 00 04



**Journey 42 black**  
Item-no. 610285 00 11



**Journey 42 white**  
Item-no. 610085 00 03

# JOURNEY Top case

## JOURNEY Top case 42

- Covers can be removed and painted to match bike color
- Watertight thanks to special seal
- Integrated bumper strip provides impact protection
- Case shell made of highly impact-resistant plastic
- Case and top case available with simultaneous locking
- Comprehensive range of accessories
- Incl. key and cylinder
- Space for one helmet

### Backrest for top case

A backrest on the top case keeps your passenger comfortable even on long trips. Made of soft black polyurethane and designed for optimal shock absorption.



**Backrest**  
Item-no. 700308

### Railing for top case

This rail lets you transport more things you need on your trip (a sleeping bag, air mattress, etc.). The rail is made of steel tubing and protected with a black plastic coating.



**Railing**  
Item-no. 610060 00 01

### Inner bag

Easier loading before and at the end of the ride, there's no need to remove the whole case – just take out the inner bag. Made of wear-resistant black fabric with 2-way zipper and adjustable carrying strap.



**Inner bag**  
Item-no. 700503

INFO

### Top case Journey 42

Weight: 3,8 kg  
Capacity: 40 Litres  
Load: 5 kg

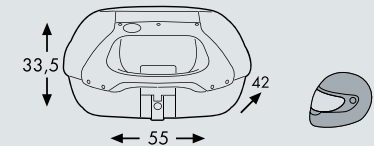

### Fits with



Easyrack / Alurack / Rear rack tube type

Spare parts see page 72



# JUNIOR / JUNIOR FLASH

Classic design by Hepco&Becker



For many years, the undisputed sales champ – always comes in first in comparison tests. Our „Junior“ case series.

It doesn't matter which version or size you pick: Junior cases are designed and tailored for strength and practicality in mind.

We offer Junior side cases with 30 or 40 liters of space. Robust and highly resilient through its double-wall construction, it forgives rough landings, protects its contents even during small jolts and is watertight. The case's side lid makes it optimal for loading. Two strong tension belts hold the content in place even when the lid is open.

The Junior 40 has space for a helmet.



# JUNIOR / JUNIOR FLASH

High quality exclusive surface appearance  
Covers are smooth and varnished; example shown here is silver



Available in 2 sizes, so well suited as enduro set



Side cases Junior / Junior Flash 40 space for one helmet, 2 tension belts in each case shell



Surface detail Junior Flash. Above is the Junior Flash with silver cover.  
Cover can be removed and painted to match your bike.



Dynamic look on the bike due to asymmetrical design with separate cases for the left and the right side



High quality grained plastic surface

# JUNIOR/JUNIOR FLASH Side case

Classic design by Hepco&Becker



## Junior 30

Item-no. 610033 00 01

## Junior 40

Item-no. 610036 00 01



## Junior 30 Flash

Item-no. 610233 00 09

## Junior 40 Flash

Item-no. 610236 00 09



## Junior 30 Flash black

Item-no. 610233 00 11

## Junior 40 Flash black

Item-no. 610236 00 11

# JUNIOR/JUNIOR FLASH Side case

HEPCO&BECKER

*Classic*  
SINCE 1975

## JUNIOR / JUNIOR FLASH Side case

- Completely watertight thanks to a special seal
- Highly impact-resistant plastic shells with extremely rugged metal locks
- Also available as an Enduro set (30lt/40lt or 40lt/ 30lt)
- Aerodynamic design
- Junior Flash with painted covers, removable for custom painting
- Case and top case available with simultaneous locking (please specify when ordering).
- Matching-look top cases from the Junior and Journey series
- Incl. key and cylinder



Junior 40

Junior 30

### Accessories:

#### Inner bags for Junior/Junior Flash side cases

Easier loading before and at the end of the ride, there's no need to remove the whole case – just take out the inner bag. Made of hard-wearing black fabric with 2-way zipper and adjustable carrying strap.

**Junior 30 left**  
Item-no. 700506

**Junior 40 left**  
Item-no. 700501

**Junior 30 right**  
Item-no. 700507

**Junior 40 right**  
Item-no. 700502

## INFO

**Junior 30**  
Weight: 3,5 kg  
Capacity: 27 Litres  
Load: 10 kg each case

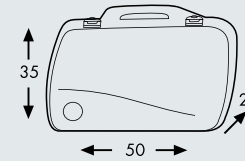

**Junior 40**  
Weight: 3,8 kg  
Capacity: 37 Litres  
Load: 10 kg each case

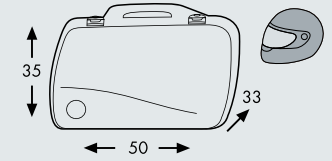

**Junior Flash 30**  
Weight: 3,5 kg  
Capacity: 27 Litres  
Load: 10 kg each case

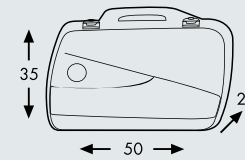

**Junior Flash 40**  
Weight: 3,8 kg  
Capacity: 37 Litres  
Load: 10 kg each case

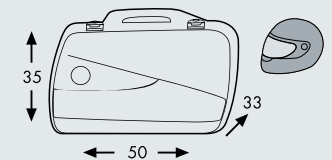

Fits with



Side case carrier / Complete carrier

Spare parts see page 63



# JUNIOR / JUNIOR FLASH ENDURO SET

The Junior series is available as an Enduro set with 2 different case sizes.

For those who like an especially slim bike width and have different luggage carrier widths due to the high exhaust system position typical of Enduros.

The Enduro set can remedy this asymmetry. Depending on which side the muffler is on, we provide the right combination of 30 or 40 liters case.

**Side case set Enduro  
Junior 30 left / Junior 40 right**  
Weight: 3,5/3,8 kg  
Capacity: 27 Litres / 37 Litres  
Dimensions 50 x 35 x 26/50 x 35 x 33cm  
Load: 10 kg each case



**Enduro Set Junior**  
Item-no. 610038 00 01

**Side case set Enduro  
Junior 40 left / Junior 30 right**  
Weight: 3,8/3,5 kg  
Capacity: 37 Litres / 27 Litres  
Dimensions 50 x 35 x 33/50 x 35 x 26cm  
Load: 10 kg each case



**Enduro Set Junior**  
Item-no. 610037 00 01

**Enduro Set Junior Flash silver**  
Item-no. 610238 00 09



**Side case set Enduro  
Junior Flash 30 left / 40 right**  
Weight: 3,5/3,8 kg  
Capacity: 27 Litres / 37 Litres  
Dimensions 50 x 35 x 26/50 x 35 x 33cm  
Load: 10 kg each case

**Enduro Set Junior Flash silver**  
Item-no. 610237 00 09



**Side case set Enduro  
Junior Flash 40 left / 30 right**  
Weight: 3,8/3,5 kg  
Capacity: 37 Litres / 27 Litres  
Dimensions 50 x 35 x 33/50 x 35 x 26cm  
Load: 10 kg each case

**Enduro Set Junior Flash black**  
Item-no. 610238 00 11



**Enduro Set Junior Flash black**  
Item-no. 610237 00 11



# JUNIOR TC 40 Top case

HEPCO&BECKER

*Classic*  
SINCE 1975

- Completely watertight thanks to a special seal
- Highly impact-resistant plastic shells for absolute robustness.
- Comprehensive range of accessories available
- Incl. key and cylinder



## Junior 40

Item-no. 610040 00 01

### Backrest for top case

A backrest on the top case keeps your passenger comfortable even on long trips. Made of soft black polyurethane and designed for optimal shock absorption.



Backrest  
Item-no. 700303

### Railing for top case

This rail lets you transport more things you need on your trip (a sleeping bag, air mattress, etc.). The rail is made of steel tubing and protected with a black plastic coating.



Railing  
Item-no. 610055 00 01

### Inner bag

Easier loading before and at the end of the ride, there's no need to remove the whole case – just take out the inner bag. Made of wear-resistant black fabric with 2-way zipper and adjustable carrying strap.



Inner bag  
Item-no. 700510

INFO

### Top case Junior 40

Weight: 4,4 kg  
Capacity: 40 Litres  
Load: 5 kg

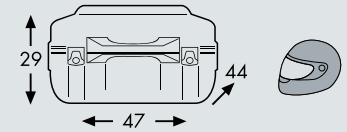

Fits with



Easyrack / Alurack /  
Rear rack tube type

Spare parts see page 73



# JUNIOR / JUNIOR FLASH TC 55 Top case



**Junior 55**  
without covers  
Item-no. 610047 00 01



**Junior Flash 55**  
Covers silver  
Item-no. 610047 00 09



**Junior Flash 55**  
Covers black gloss  
Item-no. 610047 00 11

## INFO

### Top case Junior 55/Flash

Weight: 4,9 kg  
Capacity: 55 Litres  
Load: 5 kg

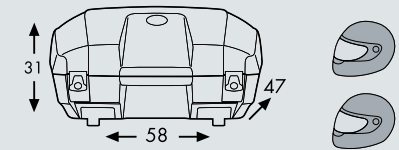

### Fits with



**Easyrack / Alurack /  
Rear rack tube type**

**Spare parts see page 73**

### Backrest for top case

A backrest on the top case keeps your passenger comfortable even on long trips. Made of soft black polyurethane and designed for optimal shock absorption.



**Backrest**  
Item-no. 700320

### Railing for top case

This rail lets you transport more things you need on your trip (a sleeping bag, air mattress, etc.). The rail is made of steel tubing and protected with a black plastic coating.



**Railing**  
Item-no. 610051 00 01

### Inner bag

Easier loading before and at the end of the ride, there's no need to remove the whole case. Made of wear-resistant black fabric with 2-way zipper and adjustable carrying strap.



**Inner bag**  
Item-no. 700503

- The Junior top cases available in 3 version: with covers in silver or black and without cover
- Watertight thanks to a special seal.
- Floor mat and small document sleeve.
- Highly impact-resistant plastic shells for absolute robustness.
- Incl. key and cylinder
- Offers 55 liters of storage space for 2 full-face helmets and more.

# SPARE PARTS FOR JOURNEY/JUNIOR/JUNIOR FLASH

## Spare Parts Journey



### Description

1. Fixing lock for side case with cylinder, black\*
1. Fixing lock with cylinder for top case, black\*
2. Key\*
3. Cylinder with key for Pos1. and 4.\*
4. Lid lock without cylinder, black\*
5. Pin for hinge
6. Logo ø50mm
7. Sealing
8. Lid holder
9. Cover silver
9. Cover recon
9. Cover black
9. Cover white
10. Strap
11. Bumper guard (give colour number)
12. Lock cover
13. Fixing clamp
14. Locating moulding

\*Indicate the key number

\*\*Example: Desired key number: 140 - Order number: 710112 00 01-140 01-140

### Item-no.

- 710111 00 01-xxx\*\*
- 710112 00 01-xxx\*\*
- 710110
- 710109
- 710136
- 710030
- 710000
- 710013
- 710016
- 710009 00 09
- 710009 00 04
- 710009 00 11
- 710009 00 03
- 710011
- 710014
- 710118
- 710119
- 710117

## Spare Parts Junior / Junior Flash Side case



### Description

1. Fixing lock with cylinder, black\*
2. Key\*
3. Cylinder with key for Pos.1 and 4.\*
4. Lid lock with cylinder, black\*
5. Logo ø50mm
6. Sealing
7. Strap
8. Floor plate 30 left
8. Floor plate 30 right
8. Floor plate 40 left
8. Floor plate 40 right
9. Cover silver left
9. Cover silver right
9. Cover black left
9. Cover black right

\*Indicate the key number

\*\*Example: Desired key number: 140 - Order number: 710112 00 01-140 01-140

### Item-no.

- 710111 00 01-xxx\*\*
- 710110
- 720109
- 710114 00 01-xxx\*\*
- 710000
- 710038
- 710040
- 710034
- 710035
- 710036
- 710037
- 710044 00 09
- 710045 00 09
- 710044 00 11
- 710045 00 11

# JOURNEY / JUNIOR TOP CASE SERIES

The practical storage space for your motorbike



Within our Topcase series you can choose from a wide range of sizes from 29 to 55 litres capacity and different versions with and without covers. Whether for the scooter or as additional storage space on the tourer - we have the right topcase for every need. Combined with a Hepco&Becker rear rack tube type or an Alurack/Easyrack top case carrier, the top cases are securely fastened and cut a fine figure on your motorcycle even without a side case. If your bike is already equipped with an external supplier rack, we also offer top case versions with a universal adapter plate (top case pallet). For all Journey topcases there is room for at least one helmet and more. The shells are made of high-quality, impact-resistant plastic. 100% waterproof due to circumferential rubber seal and overlapping of the shells. Useful accessories such as backrests, railing and inner bags available.



Always enough storage space for at least one helmet and more...



Wide range of accessories:  
Inner bags, railings and back rests



Suitable for every taste and need  
Different colours, panels and sizes available



# JOURNEY TC 30

With universal pallet for existing rear racks/carriers

High quality design with special surface



Example: Top case TC 52 with glossy black cover



## Journey TC 30

Item-no. 610206 00 01

Incl. top case pallet  
+ mounting material



Backrest  
Item-no. 700313

The plate is placed under the topcase pallet to compensate for unevenness in the carrier substrate or to prevent the pallet from bending.



Reinforcement plate  
Item-no. 710153

INFO

**Journey TC 30**  
Weight: 3,0 kg  
Capacity: 29 Litres  
Load: 5 kg

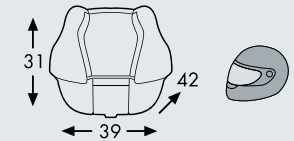

Fits with



Existing rear racks/carriers

- Top case with a 29 litre capacity - ideal for every scooter
- Front cover black gloss with red insert
- Top case pallet for mounting on every rear rack included
- Incl. key and cylinder
- Space for one helmet



With push button actuation

# JOURNEY TC 40

For Easy-/Alurack and Rear rack tube type



**Journey TC 40 silver**

Cover silver  
Item-no. 610088 00 09



Bottom view  
lock latch  
on rear rack



**Journey TC 40 black**

without cover  
Item-no. 610088 00 01

With universal pallet for existing rear racks/carriers



**Journey TC 40 black**

without cover  
Item-no. 610089 00 01



Incl. top case pallet  
+ mounting material



Bottom view  
Locked on  
top case pallet



**Journey TC 40 silver**

Cover silver  
Item-no. 610089 00 09

# JOURNEY TC 40

## JOURNEY Topcase TC 40

- The Journey top case 40 available in 2 versions  
black with red reflector / silver with clear reflector
- Case shell made of highly impact-resistant plastic
- Comprehensive range of accessories available
- Incl. key and cylinder
- Version with pallet for universal mounting
- Space for one helmet

### Railing for top case

This rail lets you transport more things you need on your trip (a sleeping bag, air mattress, etc.).  
The rail is made of steel tubing and protected with a black plastic coating.

### Backrest for top case

A backrest on the top case keeps your passenger comfortable even on long trips. Made of soft black polyurethane and designed for optimal shock absorption.



Backrest for TC 40 Item-no. 700311  
Railing for TC 40 Item-no. 610061 00 01

### Inner bag

Easier loading before and at the end of the ride, there's no need to remove the whole case – just take out the inner bag. Made of wear-resistant black fabric with 2-way zipper and adjustable carrying strap.



Inner bag for TC 40  
Item-no. 700510



The plate is placed under the topcase pallet to compensate for unevenness in the carrier substrate or to prevent the pallet from bending.



Reinforcement plate  
Item-no. 710153

## INFO

**Journey TC 40**  
Capacity: 35 Litres  
Weight: 4,0 kg  
Load: 5 kg

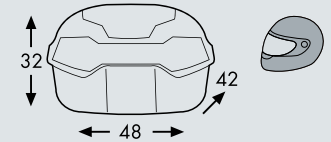

**Fits with**



**Easyrack / Alurack /  
Rear rack tube type**

**Journey TC 40**  
Capacity: 35 Litres  
Weight: 4,0 kg  
Load: 5 kg

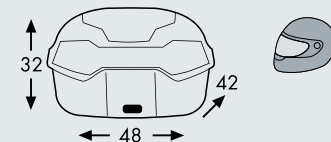

**Fits with**



**Existing rear racks/carriers**

**Spare parts see page 72**

# JOURNEY TC 50

For Easy-/Alurack and Rear rack tube type



**Journey TC 50 silver**  
Cover silver  
Item-no. 610086 00 09

With universal pallet for existing rear racks/carriers



**Journey TC 50 black**  
without cover  
Item-no. 610087 00 01



Bottom view  
lock latch  
on rear rack



Incl. top case pallet  
+ mounting material



Bottom view  
Locked on  
top case pallet



**Journey TC 50 black**  
without cover  
Item-no. 610086 00 01



**Journey TC 50 silver**  
Cover silver  
Item-no. 610087 00 09

# JOURNEY TC 50

## JOURNEY Topcase TC 50

- The Journey top case 50 available in 2 versions  
black with red reflector / silver with clear reflector
- Case shell made of highly impact-resistant plastic
- Comprehensive range of accessories available
- Incl. key and cylinder
- Version with pallet for universal mounting
- Space for two helmets

### Railing for top case

This rail lets you transport more things you need on your trip (a sleeping bag, air mattress, etc.).  
The rail is made of steel tubing and protected with a black plastic coating.

### Backrest for top case

A backrest on the top case keeps your passenger comfortable even on long trips. Made of soft black polyurethane and designed for optimal shock absorption.



Backrest for TC 50 Item-no. 700305  
Railing for TC 50 Item-no. 610061 00 01

### Inner bag

Easier loading before and at the end of the ride, there's no need to remove the whole case – just take out the inner bag. Made of wear-resistant black fabric with 2-way zipper and adjustable carrying strap.



Inner bag for TC 50  
Item-no. 700503



The plate is placed under the topcase pallet to compensate for unevenness in the carrier substrate or to prevent the pallet from bending.



Reinforcement plate  
Item-no. 710153

INFO

**Journey TC 50**  
Weight: 4,3 kg  
Capacity: 49 Litres  
Load: 5 kg

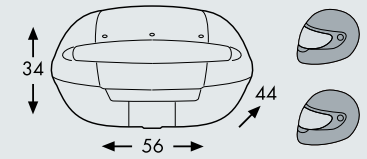

Fits with



**Easyrack / Alurack /  
Rear rack tube type**

**Journey TC 50**  
Weight: 4,3 kg  
Capacity: 49 Litres  
Load: 5 kg

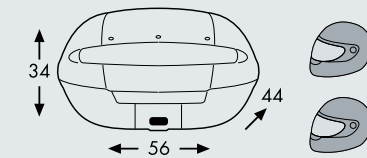

Fits with



**Existing rear racks/carriers**  
**Spare parts see page 72**

# JOURNEY TC 52

INFO

## Journey TC 52 silver

Cover silver  
Item-no. 610207 00 09



## Journey TC 52 recon

Cover arctic  
Item-no. 610207 00 04

## Journey TC 52 black

Cover black gloss  
Item-no. 610207 00 04

**Journey TC 52**  
Weight: 4,8 kg  
Capacity: 52 Litres  
Load: 5 kg

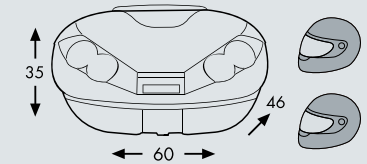

**Fits with**



**Easyrack / Alurack /  
Rear rack tube type**  
**Spare parts see page 72**

### Backrest for top case

A backrest on the top case keeps your passenger comfortable even on long trips. Made of soft black polyurethane and designed for optimal shock absorption.



Backrest for TC 52  
Item-no. 700314

### Railing for top case

This rail lets you transport more things you need on your trip (a sleeping bag, air mattress, etc.). The rail is made of steel tubing and protected with a black plastic coating.



Railing for TC 52  
Item-no. 610058 00 01

### Inner bag

Easier loading before and at the end of the ride, there's no need to remove the whole case. Made of wear-resistant black fabric with 2-way zipper and adjustable carrying strap.



Inner bag for TC 52  
Item-no. 700503

- The Journey 52 top case - available in 3 colours: Cover silver, black or arctic
- Watertight thanks to special seal
- Case shell made of highly impact-resistant plastic
- Comprehensive range of accessories available
- Incl. key and cylinder
- Space for two helmets

# ORBIT TC 54

- Top case made of black, highly impact resistant plastic
- Futuristic design with distinctive surface structures
- New all-in-one lock concept
- Easy to handle
  - just set the top case down and click it in
- Waterproof
- Optional railing or backrest available
- Carrying handle integrated
- Incl. key and cylinder
- Space for 2 helmets



**Topcase Orbit 54**  
Item-no. 610290 00 01



## INFO

**Top case Orbit 54**  
Weight: 4,6 kg  
Capacity: 54 Litres  
Load: 5 kg

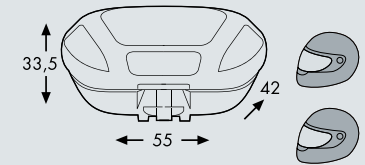

**Fits with**



**Alurack / Existing rear racks/carriers**

**Spare parts see page 73**

### Backrest for top case

A backrest on the top case keeps your passenger comfortable even on long trips. Made of soft black polyurethane and designed for optimal shock absorption.



**Backrest**  
Item-no. 700321

### Railing for top case

This rail lets you transport more things you need on your trip (a sleeping bag, air mattress, etc.). The rail is made of steel tubing and protected with a black plastic coating.



**Railing**  
Item-no. 610056 00 01

### Inner bag

Easier loading before and at the end of the ride, there's no need to remove the whole case. Made of wear-resistant black fabric with 2-way zipper and adjustable carrying strap.



**Inner bag**  
Item-no.700503



**Floor mat**  
Item-no.710225

**Document bag**  
Item-no.710049

# JOURNEY TOP CASE SPARE PARTS

## Spare parts JOURNEY top case 40/50



### Description

### Item-no.

1. Fixing lock for top case, black with cylinder*	710112 00 01-xxx**
2. Fixing clamp	710119
3. Locating moulding	710117
4. Lock cover	710118
5. Key*	710110
6. Cylinder with key for Pos.1 and 7*	710109
7. Lid lock without cylinder, black	710137
8. Pin for hinge	710030
9. Logo ø50mm	710000
10. Sealing TC 40	710019
10. Sealing TC 50	710027
11. Lid holder	710016
12. Cover TC 40 silver	710010
12. Cover TC 50 silver	710012 00 09
13. Reflector TC 40 red	710021
13. Reflector TC 40 clear	710022
14. Reflector TC 50 red	710020
14. Reflector TC 50 clear	710023
15. Lock unit with cylinder, black*	710139
16. Universal pallet	710050
17. Strap	710011
18. Cover	710098

## Spare parts JOURNEY top case 52



### Description

### Item-no.

1. Fixing lock for top case, black with cylinder*	710112 00 01-xxx**
2. Fixing clamp	710119
3. Lock cover	710118
4. Key*	710110
5. Cylinder with key for Pos1. and 6*	710109
6. Lid lock without cylinder, black	710137
7. Pin for hinge	710030
8. Logo ø50mm	710000
9. Sealing	710026
10. Lid holder	710016
11. Cover silver	710015 00 09
11. Cover recon	710029 00 04
11. Cover black	710029 00 11
12. Reflector left	710024
13. Reflector right	710025
14. Strap	710011



# JUNIOR/ORBIT TOP CASE SPARE PARTS

## Spare parts JUNIOR / FLASH top case 55



## Description

## Item-no.

1. Top case fixing lock, black with cylinder*	710112 00 01-xxx**
2. Lid lock with cylinder, black*	710114 00 01-xxx**
3. Cylinder with key*	710109
4. Key*	710110
5. Felt insert	710216
6. Lid holder	710016
7. Sealing	710042
8. Document bag	710049
9. Strap	710011
10. Logo ø50mm	710000
11. Reflector	710043
12. Fixing clamp	710119

## Spare parts JUNIOR top case 40

## Description / Item-no.



1. Top case fixing lock, black with cylinder*	710102 00 01-xxx**
2. Lid lock with cylinder, black*	710114 00 01-xxx**
3. Cylinder with key*	710109
4. Key*	710110
5. Logo ø50mm	710000
6. Sealing	710041
7. Lid holder	710016
8. Strap	710039
9. Lock cover	710118
10. Fixing clamp	710119
11. Locating moulding	710117

## Spare parts ORBIT top case 54

## Description / Item-no.



1. Fixing lock with cylinder*	710146
2. Fixing clamp with springs	710090
3. Cover fixing clamp+washer	710091
4. Fixing lock bottom	710092
5. Pin for hinge	710030
6. Key*	710110
7. Cylinder with key*	710116
8. Lid holder	710016
9. Logo	710096
10. Strap inc.rivets+washers	710094
11. Sealing black	710093
12. Universal pallet	610149 00 01

\*Indicate the key number

\*Indicate the key number

\*\*Example: Desired key number: 140 - Order number: 710112 00 01-140 01-140

# XCORE

Stylish travel companion for any weather



**XCORE**

Whether you're going on holiday in bright sunshine or on an excursion in light drizzle, your luggage stays dry and safe in the Xcore side case. It's a pleasure to be well-equipped when travelling along country roads or exploring new regions.

The high-quality workmanship is already evident from the outside. Made of two black, highly impact-resistant plastic shells that provide the necessary robustness. The front is adorned with an anodised aluminium plate with Xcore embossing – a design that matches many machines.

Openable on both sides, it's ideal for keeping provisions, rain gear and much more besides close at hand when you're on the move. Packing is also easy, as the lid is completely removable and lockable.

As usual, you can rely on our theft-proof design: the case can be locked to the C-Bow holder from Hepco&Becker. So your luggage can stay on your bike during your break. When you arrive at your destination, extend the robust carrying handle with logo lettering and check in to your accommodation in style.

# XCORE

Robust thanks to two highly impact-resistant plastic shells  
Aluminium panels are easy to replace



Convenient retractable handle allows for easy handling



Lock with integrated hinge, handy push operation  
Key and lock cylinder included



Waterproof due to integrated lid seal and raised case frame



Theft-proof attachment to the C-Bow



Special look due to combination of aluminium and plastic with different surfaces

# XCORE

Stylish travel companion for any weather

## XCORE



**Xcore black**

Item-no. 610295 00 01

**Xcore**

Item-no. 610295 00 00

**INFO**

**Xcore C-Bow**  
Weight: 2,8 kg  
Capacity: 18 Litres  
Load: 5 kg each case

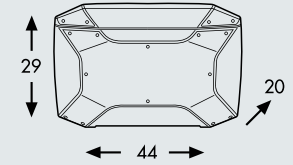

**Fits with**



**C-Bow holder**

Maximum speed: 130 km/h



Lid can be opened on both sides  
Lid can also be completely removed!

# XCORE

## XCORE C-Bow

- High-quality anodised aluminium sheet with Xcore embossing on the front
- Made of 2 highly impact-resistant plastic shell elements
- Theft-proof locking
- Exclusively for the patented Hepco&Becker C-Bow system
- Lid can be opened on both sides
- Lid can also be completely removed!
- Absolutely watertight due to integrated seal
- Robust carrying handle with folding function
- Incl. 2 keys and lock cylinder



## XCORE ACCESSORIES



Easier loading before and at the end of the ride, there's no need to remove the whole case. Made of wear-resistant black fabric with 2-way zipper and adjustable carrying strap.

**Inner bag  
Item-no. 700526 black**

## SPARE PARTS XCORE



### Description/Item-no.

1. Xcore Lid  
710257 00 01
2. Xcore Body, without attachments  
710158 00 01
3. Xcore Lid lock without cylinder  
710159 00 01
4. Cylinder with key \*  
710109-xxx\*\*
5. Key\*  
710110-xxx\*\*
6. Xcore Sealing  
710160 00 01

\*Indicate the key number

\*\*Example: Desired key number: 140  
Order number: 710110-140

# ORBIT SIDE CASE

Be different



Following the „Be different“ motto, we have created an innovative product for the motorcycle industry with the new Orbit side case.

A striking accomplishment at first glance, furthered with closer inspection, one can notice its distinct design cues. The Orbit side case is the perfect choice whether you have to run an errand or take a weekend trip. The case differentiates itself from other side cases due to the modern look. The All-In-One design concept combines a lid and retainer lock which makes handling very easy and allows to the contents to be locked safely.

The Orbit SC must be combined with the C-Bow carrier for your specific bike. Without the cases, the C-Bow Holder remains unobtrusive on the bike maintaining the look. Obligatory at Hepco & Becker: 100% waterproof!

# ORBIT SIDE CASE



## Orbit Sidecase

Item-no. 610293 00 01

## INFO

**Orbit Side case**  
Weight: 1,8 kg  
Capacity: 15 Litres  
Load: 3 kg each case

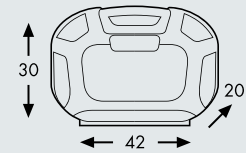

**Fits with**



**C-Bow holder**



Full of storage space  
Plenty of room for shopping despite the small size...



**Waterproof**  
Through integrated seals in signal colours.



All-in-one lock design - Combines a cover and stop latch for simple use.

## Inner bag

Easier loading before and at the end of the ride, there's no need to remove the whole case. Made of wear-resistant black fabric with 2-way zipper and adjustable carrying strap.



**Inner bag**  
Item-no. 700521 black

# STRAYKER

The elegant classic with a high-quality appearance



A classic of the highest quality! These elegant retro bags hark back to the leather suitcases of generations past. The Strayker case is not made of leather, but of high-resistance, watertight soft-feel material with a leather look that holds its shape excellently. With its color-contrasting corner applications made of enameled plastic, it is a true highlight for any roadster and a real alternative to hard-shell cases. Off the bike, it also looks great as an everyday briefcase. It has plenty of space for A4 folders or a laptop.



# STRAYKER



**Strayker C-Bow**  
Item-no. 620945 00 01



**Strayker**  
Item-no. 620940 00 01



Softfeel material in leather look with soft feel  
High-quality metal locks



Ergonomic carrying handle, spring-loaded  
Colour contrasting corner attachments



**Inner bag for Strayker**  
Item-no. 700405

Easier loading before and at the end of the ride, there's no need to remove the whole case – just take out the inner bag. Made of hard-wearing black fabric with 2-way zipper and adjustable carrying strap.

## INFO

**Side case Strayker**  
Weight: 2,6 kg  
Capacity: 16 Litres  
Load: 5kg each case

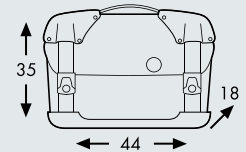

**Fits with**



**C-Bow holder or  
leather bag holder**

**Rain hood for Strayker**  
(without picture)

**Item-no. 700415**



# XTRAVEL

Explore & Travel - Xtravel



Explore & Travel - This motto gave its name to this new line of bags. A collection created to discover the new in the distance. No matter with which motorcycle, no matter where the journey goes - the range of applications of Xtravel is almost limitless. Multifunctional and universally applicable, almost no wishes remain unfulfilled.

We have succeeded in creating a collection that is waterproof as well as robust, solid, suitable for off-road use and simply stylish. In addition, the functionality of the attachment to the motorcycle is essential: Whether on the C-Bow holder, the side case carrier or the rear section of the motorcycle - every bag has its purpose.

You can drive with the Xtravel Basic around the world or with the Xtravel C-Bow version to the cafe, whether in unpaved terrain or on asphalt - Xtravel will also convince you.

# XTRAVEL

Thermoformed EVA front provides stability  
High-quality G-Hook closure elements made of anodised aluminium



Xtravel Basic:  
Front flap with integrated luggage net



Matching rear bag available  
Can also be used as backpack



Water-repellent outer material  
Connecting belt for mutual tensioning

Integrated inner bag with roll-top closure - absolutely waterproof



Lateral MOLLE-system (loops) for the attachment of optional accessories



# XTRAVEL BASIC

Explore & Travel - Xtravel



**XTravel Basic**  
Item-no. 640630 00 01



Special adapter plate for all tubular side case carrier included

## INFO

**Xtravel Basic**  
Weight: 2 kg  
Capacity: 33 Litres  
Load: 10 kg each case

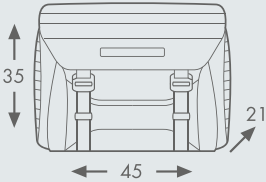

Fits with



Side case carrier / Complete carrier



Compatible with Rotopax



For attachment to the side case carrier a carrier-specific mounting kit is required - see model list p.189

# XTRAVEL C-BOW

Explore & Travel - Xtravel

# XTRAVEL



**XTravel C-Bow**  
Item-no. 640632 00 01

Connecting belt for mutual tensioning included



**INFO**

**Xtravel C-Bow**  
Weight: 2 kg  
Capacity: 19 Litres  
Load: 5 kg each case

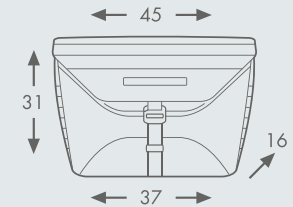

**Fits with**



**C-Bow holder**

**More products of Xtravel:**



**Xtravel XL - see page 93**  
**Xtravel M - see page 94**

# ROYSTER SPEED

Uncompromisingly sporty



Royster Speed – uncompromisingly sporty Form follows performance. The Royster Speed is streamlined, compact, no-frills and has been reduced to the essential features that a bag with this requirement profile must have.

It is made of robust and resistant EVA material, which also gives the Royster bag its dimensional stability. Water-repellent on the outside, the contents are protected by an additional, waterproof inner pocket with a roll top closure.

Safety in the dark is enhanced by the reflector triangles. Tried-and-tested convenience features, such as the theft-proof C-Bow locking mechanism or robust zips that can be additionally secured with the addition of a lock, are obligatory.

The Royster Speed is ready to match the sporty design and performance of current motorcycles.

# ROYSTER SPEED



**Royster Speed  
C-Bow yellow**  
Item-no. 640624 00 07

**Royster Speed  
C-Bow black**  
Item-no. 640624 00 01

## INFO

**Royster Speed C-Bow**  
Weight: 2,6 kg  
Capacity: 13 Litres  
Load: 5 kg

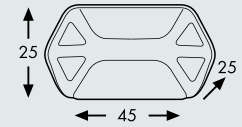

**Fits with**



**C-Bow holder**



Theft-proof attachment to the C-Bow Handle for easy transport



Waterproof, sewn-in inner bag with roll-top closure



Reflective details  
Rubberised zip

## More products of the Royster series:



**ROYSTER REAR BAG - see page 97**  
**ROYSTER TANK BAG- see page 110**

# ROYSTER NEO

Design taken to the next level



As a visual highlight among the side panniers, it impresses with its independent, striking and fresh design. It is made of robust and resistant EVA material, which gives the Royster Neo bag its dimensional stability. The front is covered with abrasion-resistant polyester 1200D. The back panel is coated with polyurethane in „Diamond Shape Optics“. This increases the dirt resistance and makes cleaning easier.

Its light weight makes the bag very handy and allows it to be carried easily thanks to a functional handle. Water-repellent on the outside, the contents are protected by an additional, waterproof and removable inner pocket. The volume can be increased by 1.5 litres thanks to the all-round zip.

The inside of the bag is locked with a sophisticated combination lock. The C-Bow holder ensures theft-proof mounting on the motorbike.



# ROYSTER NEO



## Royster Neo C-Bow yellow

Item-no. 640622 00 07

## Royster Neo C-Bow black

Item-no. 640622 00 01

## INFO

**Royster Neo C-Bow**  
Weight: 1,7 kg  
Capacity: 16-17,5 Litres  
Load: 5 kg

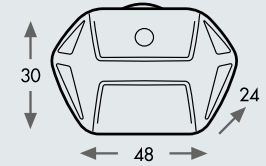

Fits with



C-Bow holder



Volume increase through extension zip for more storage space



An integrated polyester inner bag keeps the bag watertight.



Integrated combination lock

## More products of the Royster series:



**ROYSTER REAR BAG** - see page 97  
**ROYSTER TANK BAG** - see page 110

# STREET

The bag with understatement



The redesigned STREET softbags for our HEPCO&BECKER C-Bow side carriers not only look good, but they are sturdy and the contents are easily accessible. We gave the bag a minor facelift in 2020, but rest assured: different design, same quality!

Not too bulky, but the compartment capacity is definitely roomy enough for a weekend trip. The bags can withstand a brief shower, while the waterproof inner pockets will keep the contents dry during longer downpours.

Our system with the C-Bow carrier has a decisive advantage over the conventional fastening with straps under the seat: the theft-proof and secure attachment with a locking mechanism on the C-Bow carrier. No slipping, no hanging down; they retain their great shape.

Made from robust and tear-resistant polyester fabric. The back panel is reinforced with PU, resistant to dirt and water-repellent.

The contents are protected with an additional, waterproof inner lining.

# STREET



**Street C-Bow**  
Item-no. 640602 00 01

## INFO

**Street C-Bow**  
Weight: 1,5 kg  
Capacity: 16 Litres  
Load: 5kg

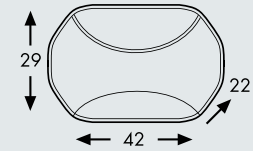

**Fits with**



**C-Bow holder**



Flutter-free carrying handle  
Watertight zippers



Waterproof inner bag with roll closure included,  
removable



Shoulder strap included

**More products of Street series:**



**STREET REAR BAG - see page 100**  
**STREET TANK BAG - see page 112**

# XTRAVEL TAIL BAG XL

Explore & Travel - Xtravel



With a generous packing volume of 50 litres, the new soft bag is perfect for longer trips. Thanks to the integrated compression straps, it can be securely fastened to the motorbike even with less luggage. A spacious, waterproof inner pocket made of polyester with the tried-and-tested roll-top closure keeps things dry when riding in the rain. The water-repellent outer material with inner coating and the covered zips mean that even short rides through light rain are easily managed.

There is a zipped mesh pocket in the lid of the bag for storing items requiring quick access. Two additional external pockets are quickly accessible through zips and offer additional packing volume. The zips to the main compartment are lockable. It is securely fastened with a reliable 4-point tensioning strap. The anti-slip material on the underside of the bag provides even more grip and the integrated seat pan pocket improves this even further. The reflective details ensure better visibility in road traffic.

# XTRAVEL TAIL BAG XL

**XTRAVEL**



## Xtravel Tail bag XL

Item-no. 640635 00 01

Included:  
4x loop straps, 80cm  
2x lashing eyes for attachment to licence plate holder



Included:  
Shoulder strap

**INFO**

### Xtravel Tail bag

Weight: 2 kg  
Capacity: 50 Litres  
Load: 12kg

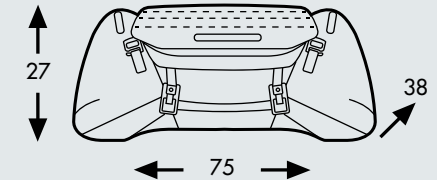

Fits with



Pillow seat



Attachment for loop straps  
Integrated carrying handle



Waterproof inner pocket with roll-top  
closure included



Integrated compression straps

More products of Xtravel series:



**XTRAVEL BASIC** - see page 84  
**XTRAVEL C-BOW** - see page 85  
**XTRAVEL M** - see page 94

# XTRAVEL REARBAG M

## XTRAVEL



Backpack function possible with the integrated straps



**Xtravel Rear bag M**  
Item-no. 640634 00 01

INFO

**Xtravel Rear bag M**  
Weight: 1,2 kg  
Capacity: 23-30 Litres  
Load: 5 kg

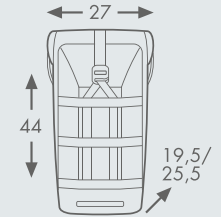

**Fits with**



**Rear rack tube type/Pillow seat**



Outer compartment with luggage net



Waterproof roll top closure



Incl. 4 tension straps for individual fastening  
Integrated volume expansion to approx. 30 L

**More products of Xtravel:**



**XTRAVEL BASIC - see page 84**  
**XTRAVEL C-BOW - see page 85**

# DRYBRID TAIL BAG

More than just your everyday luggage solution.

- Wide opening with rolltop closure
- Two wraparound compression straps
- Water-tight, heat-taped seams
- Comfortable carry handle
- Universally suitable for many motorcycle models
- Sturdy and abrasion-resistant material
- UV-resistant and very easy to clean
- Air valve on side for quick compression while packing
- Enclosed loop straps for universal 4-point fastening
- Shoulder strap optionally available



## Drybrid Bag 30

Item-no. 640015 00 01

## Drybrid Bag 50

Item-no. 640016 00 01

**NEW**

INFO

### Drybrid Bag 30

Weight: 0,9 kg  
Capacity: 30 Litres

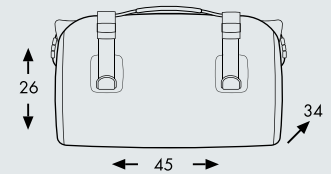

### Drybrid Bag 50

Weight: 1 kg  
Capacity: 50 Litres

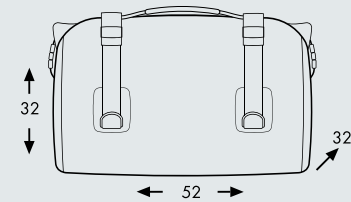

Fits with



Pillion seat / Enlargement



4 loop straps for secure lashing included with delivery



Air valve on side for quick compression while packing



Comfortable carry handle



Wide opening with rolltop closure and plastic clips on side

# ROYSTER REARBAG

Right behind you!



Now the Royster product family is complete! The unmistakable look of the Royster product line is complete with the addition of this rear bag .

The modern rear bag is a visual highlight for any pillion seat. Alongside the focus on packing volume and function, this bag claims to be contemporary yet entirely innovative.

The Royster rear bag offers two fixing methods: The bag can be mounted in a flash onto a model specific sport rack using the Lock-it/Basic fixing, or conventionally on a pillion seat using the reliable 4-point strap fixing. Thanks to both models, the rear bag is the perfect luggage solution for lots of sporty motorbikes. Whether it's for a short trip or long journey, the Royster rear bag offers a generous amount of space to complement the Royster side bag and tank bag.



# ROYSTER REARBAG

INFO



## Royster Rearbag Lock-it

Item-no. 640812 00 01 black  
Item-no. 640812 00 07 yellow

## Royster Rearbag Basic

Item-no. 640819 00 01 black  
Item-no. 640819 00 07 yellow

Belt fastening + Lock-it or Basic rear bag holder included  
Further information on page 154



## Royster Rearbag

Item-no. 640811 00 01 black  
Item-no. 640811 00 07 yellow



Belt fastening included



An integrated inner sack made of polyester is guaranteed to be watertight.



Two practical outside pockets for quick access to small travel accessories



Also suitable for a helmet thanks to the increase in volume.

**Royster Rearbag**  
Weight: 1,8 kg  
Capacity: 17-19 Litres Load: 5 kg

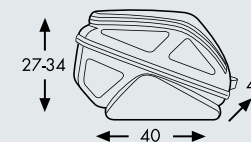

**640812 fits with**



**Sportrack / Pillow seat**

Lock-it attachment and belt fastening possible

**Royster Rearbag**  
Weight: 1,8 kg  
Capacity: 17-19 Litres Load: 5 kg

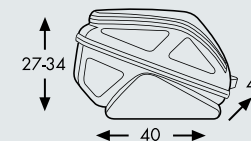

**640811 fits with**



**Pillow seat**

Only belt attachment possible

**More products of Royster series:**

**ROYSTER SIDE BAG - see page 87**  
**ROYSTER TANK BAG- see page 110**

# ROYSTER REARBAG SPORT

Right behind you!



This is our smaller relative of the Royster Rearbag with the same features, but smaller and slimmer. A large packing volume is not always desired. But the Royster Rearbag Sport also has an integrated expansion zip for more storage space.

The Royster Rearbag Sport is offered in two versions, which differ in the mounting options: In the Lock-it version, the locking unit with Lock-it rear bag holder for mounting on the sports rack is included. Straps for conventional fastening are also included. The version with belt fastening is attached conventionally to the pillion seat bench by means of a reliable 4-point tensioning belt fastening. Lock-it mounting is not possible here

Thanks to both models, the rear bag is the perfect luggage solution for lots of sporty motorbikes.

# ROYSTER REARBAG SPORT

The Lock-it Rear bag for Sportracks and pillow seats



INFO

## Royster Rearbag Sport Lock-it

Weight: 1kg  
Capacity: 11-15 Litres  
Load: 5 kg

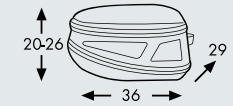

640815 fits with



Sportrack / Pillow seat

Lock-it attachment and belt fastening possible

## Royster Rearbag Sport

Weight: 1kg  
Capacity: 11-15 Litres  
Load: 5 kg

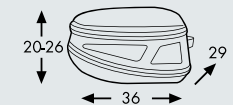

640814 fits with



Pillow seat

Only belt attachment possible

More products of Royster series:

**ROYSTER SIDE BAG - see page 87**  
**ROYSTER TANK BAG- see page 110**

## Royster Rearbag Sport

Item-no. 640814 00 01 black

Belt fastening included



Waterproof through sewn-in inner bag with roll closure

## Royster Rearbag Sport Basic

Item-no. 640820 00 01 black

Belt fastening + Lock-it or Basic rear bag holder included  
Further information on page 154



Volume increase through extension zip for more storage space



Carrying handle for easy carrying

# STREET REARBAG

Make two out of one! With facelift and additional version

The Street rear bag comes with a facelift in 2022 and in two versions:

### Strap version:

The scope of delivery now includes 4 loop straps for individual attachment, for example on the pillion seat.

### Lock-it version:

In addition to the 4 loop straps, the Lock-it tail bag holder is also included. This holder allows it to be mounted on a mini or sports rack. The mounting of the counterholder on the underside of the tail bag is the same as for the tank ring counterholder.

- The belt version is suitable for almost all motorcycles.
- Reliable tension belt fastening
- Lock-it version suitable for Minirack or Sportrack
- Volume expansion through all-round zip
- Underside made of non-slip material
- Zipped mesh compartment on the lid
- Water repellent outer material
- 2 outer compartments with zips
- Robust carrying handle
- Integrated rain cover
- Reflective details for increased visibility



**Street Rear bag**  
Item-no. 640817 00 01 black

**Street Rear bag Basic**  
Item-no. 640818 00 01 black



Organiser compartments inside the lid and additional mesh pockets



All-around zipper for volume increase  
Integrated access to the interior

INFO

### Street Rear bag Lock-it

Capacity: 7-10 Litres

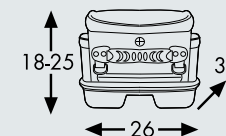

640806 fits with



Minirack / Sportrack

### Street Rear bag

Capacity: 7-10 Litres

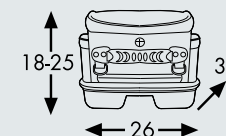

640817 fits with



Pillow seat  
Only belt attachment possible



Shoulder strap included with both versions

# SPORT STAR

## The universal rear bag

The alternative to a tank bag. The Sport Star looks great and needs no additional handles or holders.

Depending on the model, it is fastened with straps to the seat or to a rear rack. With a zipper and compression straps, its capacity can vary up to 28 liters, depending on the version.

- A choice of sizes and designs
- Flexible fastening with straps to the rear rack or pillion seat
- Premium quality
- Robust Cordura fabric
- Variable capacity with zipper and compression straps
- Can also be used as a backpack or shoulder bag
- Rain hood as a recommended accessory



Capacity increase - on all models with zipper and compression straps



**Small Sport Star Rack**

Item-no. 640012 00 00



**Small Sport Star**

Item-no. 640002 00 00



**Small Sport Star Rack**

**BMW R 1200 GS/LC**

Item-no. 640003 00 00



Small Sport Star  
Flexible attachment on the pillion seat



Small Sport Star - special version for the original rack of the BMW R 1200 GS/LC

INFO

**Small Sport Star**  
Capacity: 18-28 Litres

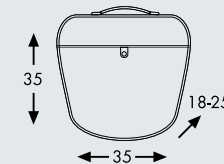

Fits with



Pillow seat

**Small Sport Star Rack**  
**BMW R 1200 GS/LC**  
Capacity: 15-25 Litres

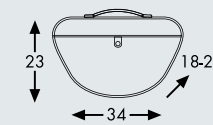

Fits with



Original rear rack  
BMW R 1200 GS

**Small Sport Star Rack**  
Capacity: 15-25 Litres

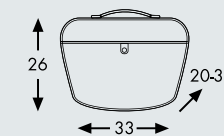

Fits with



Rear rack tube type/Easy-/Aluracks  
Sport-/Minirack

# LEGACY

From the past grows new...



since 1975  
**LEGACY**  
by HEPSCO & BECKER

The Legacy collection is characterized by timeless chic and the use of uncompromisingly high-quality materials. Functional, robust, and smart with a quality found nowhere else.

Made of wear resistant material, sewn in layers, and coated with a permanent water-repellent solution. In addition, the inner lining is made of waterproof polyester.

For the Legacy collection we use naturally refined leather materials: 3.3mm thick, naturally tanned cowhide. The leather is finished and treated by hand in our factory. This allows for a unique look. The quality of workmanship, craftsmanship, and choice of materials are the hallmarks of the Legacy line.

# LEGACY

From the past grows new...

since 1975  
**LEGACY**  
by HEPSCO & BECKER



### Legacy Courier bag C-Bow M

Item-no. 6451976 00 08 M green  
Item-no. 6451976 00 01 M black

### Legacy Courier bag C-Bow L

Item-no. 6451976 00 08 L green  
Item-no. 6451976 00 01 L black



INFO

### Legacy Courier bag M

Weight: 1,6 kg  
Capacity: 9 Litres  
Load: 3kg

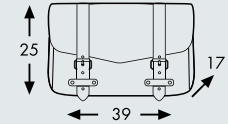

### Legacy Courier bag L

Weight: 1,6 kg  
Capacity: 11 Litres  
Load: 3kg

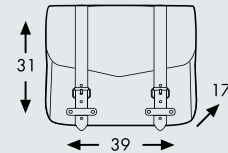

Fits with



C-Bow holder



Inside zipper trimmed in leather



Backwall made of 3,3mm thick, naturally tanned cow leather incl. C-Bow attachment

### LEGACY Shoulder strap

Item-no. 7401975 00 02  
(120 cm green)  
Item-no. 7401975 00 03  
(120 cm black)



### LEGACY Shoulder strap

Item-no. 7401975 00 01  
Leather brown



### Rain hood

LEGACY L Item-no. 700436  
LEGACY M Item-no. 700435

### Legacy Courier Bags Sets:

#### Legacy C-Bow Courier bag set M

Item-no. 6451976 00 08 MM green  
Item-no. 6451976 00 01 MM black

#### Legacy C-Bow Courier bag set L

Item-no. 6451976 00 08 LL green  
Item-no. 6451976 00 01 LL black

#### Legacy C-Bow Courier bag set M/L

Item-no. 6451976 00 08 ML green  
Item-no. 6451976 00 01 ML black

# LEGACY

Your authentic style

since 1975  
**LEGACY**  
by **HEPCO&BECKER**

The Legacy collection is characterized by timeless chic and the use of uncompromisingly high-quality materials. Functional, robust and smart, simply with that certain something. Universal, practical rear bag for individual fixing to the motorcycle. Just the right packing volume if you require a bit more space. Made of heavy duty linen, sewn in several layers and permanently water-repellent coated. Complemented by naturally tanned leather.



Shoulder strap  
(green or black)  
included

### Legacy Rear bag

Item-no. 6451975 00 08 H green  
Item-no. 6451975 00 01 H black

INFO

### Legacy Rear bag

Capacity: 25 Litres

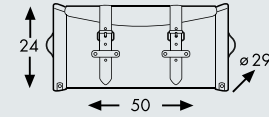

Fits with



Pillow seat / Enlargement / Solorack

### Accessories: RAIN HOOD

Item-no. 700437

More products of Legacy series:



**COURIER BAG** - see page 103  
**TOOL BAG** - see page 132



Leather handle at the side



Double zipper for easy loading  
Trimmed in leather for reinforcement



Underside with eyelets for fastening  
Edge protection



# LEGACY TANK BAGS

Your authentic style

Suitable for your Retro series, we now have the suitable tank bags for the Lock-it tank rings. The Legacy tank bags M are manufactured from hard-wearing canvas in green or black, sewn in multi-layers and coated for lasting water resistance. Complemented by naturally tanned cow hide leather. The leather is processed by hand in our factory. The quality of the finish, the craftsmanship and material selection are signs of the Legacy line. The Legacy tank bag is available in sand brown and black, including a „rugged“ look. Manufactured to have a high durability using 3mm strong shell cordovan with a sturdy, rigid interior trim. Perfect for smaller luggage. Stamped with the Legacy logo.

since 1975  
**LEGACY**  
by HEPSCO & BECKER



**Legacy Tankbag M**  
Item-no. 6451977 00 01

INFO

## Legacy Tank bag M

Capacity: 6 Litres

Load: 3 kg

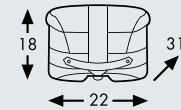

Fits with



**Lock-it**

**basic**

For differences see page 154

The matching ring for your model:  
see Model list or on the Internet.



BMW R nineT



An integrated internal sack made of polyester guarantees complete watertight usage



Manufactured in our leather factory with the highest quality of leather and workmanship.

More products of Legacy series:



**COURIER BAG - see page 103**  
**LEATHER REAR BAG - see page 133**

# EPIC / ROYSTER / STREET TANKBAG

Tank bags, small to XL



Whether you are commuting to work or taking off on a weekend adventure or long-distance journey, our tank bags are the perfect solution for transporting your most important items. With their versatile design and practical size, our bags offer plenty of space for items such as your phone, keys, wallet and even a change of clothes.

Tank bags are not only practical, but also a stylish addition to your motorcycle. They offer numerous features that have proven to be extremely useful in daily life. Two-way zips, a carry handle and an integrated rain cover are usually included as part of the basic equipment.

Thanks to the innovative Lock-it or Basic tank rings, you can quickly attach or remove the tank bags.

Not able to or don't want to have a tank ring? No problem: our Epic 11 Belt model is conventionally attached to the tank using straps.

# EPIC 16

For epic moments on your bike

- High-density EVA foams, along with tear-resistant and durable 840D Ballistic Polyester ensure it retains its shape.
- Lockable zips and robust carry handle
- Water-repellent outer material
- Additional compartments with mesh compartment inside the lid
- Small reflective details for improved visibility
- Removable, water-tight inner bag with rolltop closure, easy removal using press stud fastening
- Expanded volume thanks to all-round zip fastening
- Loop system on the lid for optional accessories such as card or smartphone pocket

**NEW**



**Epic 16**  
Item-no. 640904 00 01



Expanded volume possible



Mesh compartment in the lid



Removable, water-tight inner bag with rolltop closure, easy removal using press stud fastening



Practical Velcro fastener for attaching gloves, such as at tollbooths or fuel stations

**INFO**

**Epic 16**  
Capacity: 16-19 Litres  
Load: 3 kg

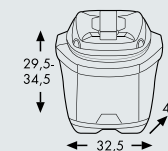

**Fits with**



**Lock-it / Basic Tankring**  
**Lock-it** **basic**

For differences see page 154  
The matching ring for your model:  
see Model list or on the Internet.

**Matching accessories**  
Map bag, Smartphone bag, Locks  
see page 116



Base plate with variable adjustment of the adapter enables optimum positioning of the EPIC on your motorbike.

# EPIC 13 / EPIC 11 / EPIC 11 Belt

For epic moments on your bike

**NEW**



**Epic 13**  
Item-no. 640903 00 01



**Epic 11**  
Item-no. 640905 00 01

**Epic 11 Belt**  
Item-no. 640902 00 01

Expanded volume possible



Practical Velcro fastener for attaching gloves, such as fuel stations



Removable, water-tight inner bag with rolltop closure, easy removal using press stud fastening



EPIC 11 Belt with flexible strap fastening

The Epic 11 Belt tank bag has been developed to be flexible and suitable for models where no model-specific training can be offered for technical reasons. Thanks to its flexible strap fastening, it fits onto a wide range of motorcycles while remaining stable and reliable at all times.

**Epic 13**  
Capacity: 13-16 Litres  
Load: 3 kg

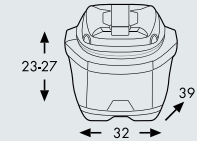

**Epic 11**  
Capacity: 11-14 Litres  
Load: 3 kg

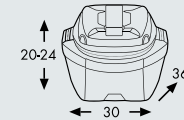

Fits with



Lock-it / Basic Tankring



For differences see page 154

The matching ring for your model:  
see Model list or on the Internet.

**Epic 11 Belt**  
Capacity: 11-14 Litres  
Load: 3 kg

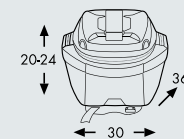

Strap fastening only

# EPIC 6 / EPIC 3

For epic moments on your bike

- High-density EVA foams, along with tear-resistant and durable 840D Ballistic Polyester ensure it retains its shape.
- Lockable zips and robust carry handle
- Water-repellent outer material
- Additional compartments with mesh compartment inside the lid
- EPIC 6: Removable, water-tight inner bag with rolltop closure, easy removal using press stud fastening
- EPIC 3: Integrated water-tight inner lining
- Loop system on the lid for optional accessories such as card or smartphone pocket

**NEW**



**Epic 6**  
Item-no. 640901 00 01

**Epic 3**  
Item-no. 640900 00 01

EPIC 6:  
Expanded volume possible



Mesh compartment in the lid



Matching accessories  
Map bag, Smartphone bag, Locks  
see page 116



Waterproof inner bag EPIC 6  
Waterproof inner lining EPIC 3

**Epic 6**  
Capacity: 6-8 Litres  
Load: 3 kg

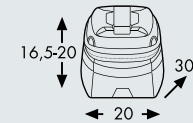

**Epic 3**  
Capacity: 3 Litres  
Load: 3 kg

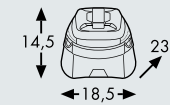

**Fits with**



**Lock-it / Basic Tankring**  
**Lock-it** **basic**

For differences see page 154  
The matching ring for your model:  
see Model list or on the Internet.



Base plate with variable adjustment of the adapter enables optimum positioning of the EPIC on your motorbike.

# ROYSTER TANK BAG

Perfectly shaped

- No direct mounting on the painted tank
- Extremely high dimensional stability due to deep-drawn EVA material - very low weight
- Cover shell made of abrasion-resistant polyester D1200
- Side mounted reflectors for better visibility
- Organizer compartment with luggage net on the inside of the lid
- Eyelets on the lid shell for attaching accessories
- Version with yellow or black 2-way zip
- Fixing by original Hepco&Becker Lock-it tank ring



## Royster Tankbag

Item-no. 640810 00 01 black  
Item-no. 640810 00 07 yellow

INFO

**Royster Tank bag**  
Capacity: 6-9 Litres  
Weight: 0,6 kg Load: 3 kg

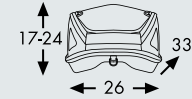

Fits with



Lock-it / Basic Tankring



For differences see page 154

The matching ring for your model:  
see Model list or on the Internet.



You can find the right ring for your model on the model list or on our website



An integrated internal sack made of polyester guarantees complete watertight usage



Enlargement of volume quite simply by a circular zip fastener



**Matching accessories**  
Map bag, Smartphone bag, Locks

# ROYSTER DAYPACK

No more and no less

- No direct mounting on the painted tank
- Extremely high dimensional stability due to deep-drawn EVA material - very low weight
- Shells made of abrasion-resistant polyester D1200
- Side mounted reflectors for better visibility
- Version with yellow or black 2-way zip
- Fixing by original Hepco&Becker Lock-it tank ring



**Royster Daypack**  
 Item-no. 640813 00 01 black  
 Item-no. 640813 00 07 yellow

INFO

**Royster Daypack**  
 Capacity: 5 Litres  
 Weight: 0,5 kg Load: 3 kg

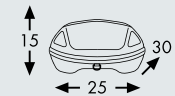

Fits with



Lock-it / Basic Tankring

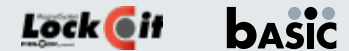

For differences see page 154

The matching ring for your model:  
 see Model list or on the Internet.



You can find the right ring for your model on the model list or on our website



2-way zipper with eyelets for optional lock



The inner lining made of polyester ensures waterproofness.

More products of Royster series:



**SIDE BAG - see page 87**  
**REAR BAG - see page 97**

# STREET TOURER ENDURO M

Tank bag series small to XL

- 100% polyester (with water-resistant coating)
- No direct mounting on the painted tank
- With volume expansion
- Extremely high dimensional stability due to deep-drawn EVA material with low weight
- 3M-SCOTCHLITE™ Reflex piping, handle, luggage hook and shoulder strap
- Flexible bottom shell
- Adapts optimally to the tank geometry
- Integrated Rain hood
- Fixing by Lock-it tank ring
- With side outer pockets



**Street Tourer Enduro M**  
Item-no. 640816 00 01

INFO

## Street Tourer Enduro M

Capacity: 10-14 Litres

Load: 3 kg

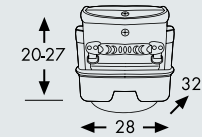

Fits with



Lock-it / Basic Tankring



For differences see page 154

The matching ring for your model:  
see Model list or on the Internet.



Perfect fit for Enduro tanks.  
Here the example of the BMW R 1250 GS



Lateral, lower mesh facilitates access to the interior. With volume expansion



Equipment inside cover:  
map/document compartment, pen pockets,  
large compartment with Velcro closure

More products of Street series:



**SIDE BAG-** see page 91  
**REAR BAG -** see page 100



# STREET TOURER M

Tank bag series small to XL

- 100% polyester (with water-resistant coating)
- No direct mounting on the painted tank
- With volume expansion
- Extremely high dimensional stability due to deep-drawn EVA material with low weight
- 3M-SCOTCHLITE™ Reflex piping, handle, luggage hook and shoulder strap
- Integrated Rain hood
- Fixing by original Hepco&Becker Lock-it tank ring



**Street Tourer M**  
Item-no. 640805 00 01

INFO

**Street Tourer M**  
Capacity: 7-10 Litres  
Load: 3 kg

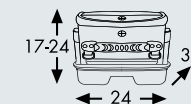

Fits with



Lock-it / Basic Tankring



For differences see page 154  
The matching ring for your model:  
see Model list or on the Internet.



Equipment inside cover:  
map/document compartment, pen pockets,  
large compartment with Velcro closure



Lateral, lower mesh facilitates access to  
the interior. With volume expansion



Map pocket integrated in lid accessible  
from the outside, with its own zipper

More products of Street series:



**SIDE BAG- see page 91**  
**REAR BAG - see page 100**

# STREET TOURER XL/L

Tank bag series small to XL



**Street Tourer L**  
Item-no. 640800 00 01



**Street Tourer XL**  
Item-no. 640801 00 01



Map pocket also suitable for Sat Nav  
Cable feed-through for map pocket  
and interior space



Outside pockets for model L, XL, Enduro:  
Front pocket and side pockets for coins,  
toll tickets, etc. Interior mesh pockets



Street Tourer Enduro M/XL  
with front pocket and logo embroidery

## INFO

### Street Tourer XL

Capacity: 18-21 Litres • Load: 3 kg

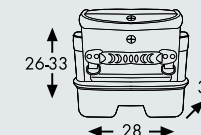

### Street Tourer L

Capacity: 10-15 Litres • Load: 3 kg

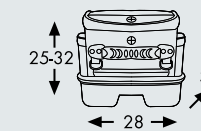

Fits with



Lock-it / Basic Tankring



For differences see page 154

The matching ring for your model:  
see Model list or on the Internet.

More products of Street series:

**SIDE BAG- see page 91**  
**REAR BAG - see page 100**

# STREET DAYPACK

## Street Daypack

As the name suggests, the Daypack is the ideal companion for the small tour. The semi-rigid lid and bottom shell are connected to each other by a water-repellent zipper. A carrying handle and shoulder strap make it easy to carry along. A Rain hood for complete water protection is included.

The tight and secure fit of the tank bag is guaranteed at all times, thanks to the lock it tank ring. Additional lashing loops included for other accessories.



**Street Daypack**  
Item-no. 640808 00 01

## Street Daypack small

Our smallest tankbag features: integrated card compartment in the lid, 2-way zipper and a possible increase in volume from 3 to 5l. A carrying handle and the shoulder strap make it easy to carry along. Separate rain hood included.



Street Daypack:  
Easy mounting on lock it tank ring

## Street Daypack small

Item-no. 640804 00 01



Street Daypack small:  
Easy mounting on metal tanks with magnets

INFO

### Street Daypack

Capacity: 4 Litres • Load: 3 kg

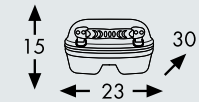

Fits with



Lock-it / Basic Tankring



For differences see page 154

The matching ring for your model:  
see Model list or on the Internet.

### Street Daypack small

Capacity: 2-3 Litres

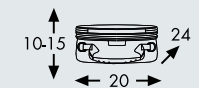

Metal tanks



Magnet mounting

# ACCESSORIES FOR TANK BAGS

## For Royster Daypack and Street Daypack

Lock-it holder for Sportracks/Miniracks - Set Item-no. 506100  
 Basic holder for Sportracks/Miniracks - Set Item-no. 516100

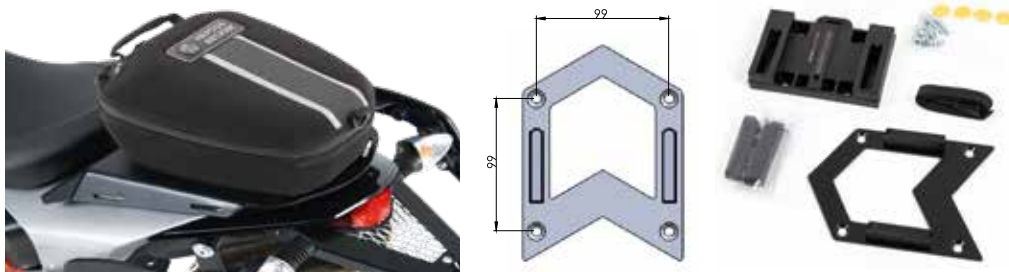

If you want to carry a Street or Royster Daypack as a rear bag on a Mini or Sportrack, this holder set is required. Incl. closure unit for mounting on the Daypack and Lock-it or Basic holder for mounting on the Mini or Sportrack.

Smartphone bag  
 Item-no. 640809 00 01



Smartphone bag, waterproof - easy to attach to the Street Daypack or Royster Tank bag using the three lashing eyes.  
 Not for Royster Daypack.

Map bag  
 Item-no. 640807 00 01



Map pocket, waterproof. Simply by using the lashing eyes to the Street Daypack or Royster Tank bag.  
 Dimension: 320x230mm  
 Not for Royster Daypack.

## For all Hepco&Becker Tank bags

Closing unit for a second tank bag

Tankring Lock-it - Item-no. 506000  
 Tankring Basic - Item-no. 516000



If you want to use a second tank bag on your Tankring, you will need this additional closing unit, which is then screwed to the second tank bag.

Combination lock  
 Item-no. 7105590



Anti-theft for the 2-way zipper. Prevents unauthorized opening of the tank bag.

Combination lock with wire  
 Item-no. 7105591



Use of powder-coated wire rope, the tank bag on a bike is securely connected

Anti-theft for bags with Lock-it funktion  
 Item-no. 506300



The safety device inside the tank/rear bag prevents unauthorised unlocking of the tank ring. Incl. combination lock. For bags with Lock-it funktion.

# TANK GUARD BAG SET V1

The perfect complement for safety guards

Suitable for many different Hepco & Becker protective guards and a useful addition for all those who want to make optimum use of their luggage storage facilities.

Extremely high dimensional stability due to deep-drawn EVA material and very low weight. The lid shell is made of abrasion-resistant 450 D polyester with a PUR coating.

The bag is water-repellent on the outside and has a smaller waterproof bag on the inside. The wide opening angle and lockable 2-way zipper make the contents easily accessible.

Firm hold through strong velcro



**Tank guard bag set V1**

Item-no. 640100 00 01

INFO

## Tank guard bag set V1

Capacity: 3 Litres

Max. Load 3kg

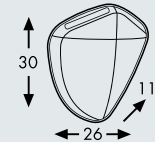

Fits with



Engine / Tank Guards



Quick access  
Firmly integrated waterproof inner pocket

Yamaha Ténéré 700 Rally



Suitable for various Hepco&Becker protection guards



BMW R 1250 GS

- Extremely high dimensional stability thanks to deep-drawn EVA material, therefore very low weight
- Back with anti-slip coating made of polyurethane and additional increased resistance to dirt
- Cover made of abrasion-proof polyester D1200
- Waterproof bag, interior organiser compartments
- Contents easily accessible thanks to wide opening

# LEATHER BAGS

Attractive leather collection for highest demands



Our leather collection doesn't just stand out for its peerless quality. Our items are made only with topgrain leather. We never use cheaper, poorer-quality split leather! Even the leather's development process and its monitoring are important to us. Above all, we see to humane treatment of livestock and observance of European environmental standards during tanning. All of our saddlebags are produced especially for us in our traditional leather craft shop. It provides the highest-quality leather and workmanship. This can be seen right away: The bags hold their shape extremely well thanks to hidden shape reinforcements and a plastic double rear wall – no drooping, no flapping. Rugged clasps and corrosion-protected accessories are a given. Sensible accessories, such as inner bags and rain hoods are available separately. The leather bags are available with two different mounting versions:



for C-Bow holder



for leather bag holder

Special mounting instructions see page 140

# LEATHER BAGS

Highest quality leather of all leather bags  
Nevada front view with emblem



Buffalo: Internal view leather bag  
Stability due to concealed shape and reinforcing parts



Manufactured in our leather factory according  
to traditional craftsmanship



Ivory Detail: Material combination  
Brass chrome-plated rivets; built-in locking mechanism



Buffalo: All handbags with lock and noble, high-quality  
accessories



Rugged: Special surface in used look  
Embossed logo

# LEGACY

## Leather briefcase college-Style



Customizer: palatina dreambikes

Anyone who likes retro will love our new briefcase! It impresses with its hip college style. The inside offers space for all the important things: Both a 13 inch notebook and A4 documents can be stored in the large main compartment. Available in 2 versions: As a leisure bag without fixing option on the bike and for fixing to the C-Bow bag holder.

All of our leather bags are produced by us in our traditional leather craft shop with leather from European livestock, tanned according to the strictest environmental standards.



Quick-release fastener with mortise locks. High-quality, corrosion-resistant metal and naturally tanned leather are used here



Interior panelling and bracing



Black leather finish  
Discreet embossed lettering



# LEGACY



The leather cleaning fluid increases longevity and weather resistance of the Legacy collection.

**Legacy leather fluid**  
Item-no. 7101975 00 01



### Legacy Briefcase C-Bow

Item-no. 6451976 00 01 A black  
Item-no. 6451976 00 08 A sandbrown

### or Legacy Briefcase

- without attachment to the bike -

Item-no. 6451975 00 01 A black  
Item-no. 6451975 00 08 A sandbrown



Legacy C-Bow version

**Accessories:**  
Legacy rain hood M  
Item-no. 700438

## INFO

### Legacy Briefcase C-Bow

Capacity: 8 Litres

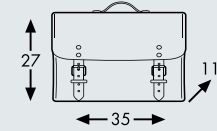

**Fits with**



**C-Bow holder**

### Legacy Briefcase

Capacity: 8 Litres

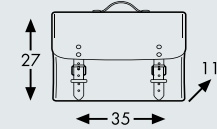

**Without attachment to the bike**

**More products of Legacy leather series:**



**REAR BAG - see page 133**

# RUGGED

## Unconventional leather bag



This bag is outside the mainstream and we like it that way! With its unconventional design, it commands to push design even further with a modern „used“ look. The RUGGED combines luggage capacity with an unmistakable appearance that looks best attached to your motorcycle. A surface treatment closes the cowhide's pores, reducing water sensitivity and increasing soil resistance. A convenient carrying handle lets you take the bag anywhere.

All of our leather bags are produced by us in our traditional leather craft shop with leather from European livestock, tanned according to the strictest environmental standards.



Lockable saddlebag. Noble, high-quality accessories and leather



Special surface in used look. Embossed logo



**Inner bag Rugged**  
Item-no. 700433

# RUGGED

INFO



## Rugged C-Bow

Item-no. 620355 00 01 black  
Item-no. 620355 00 08 brown



## Rugged Cutout

Item-no. 620350 00 01 black  
Item-no. 620350 00 08 brown



Rugged C-Bow version

**Cutout holder available for:**  
YAMAHA SCR 950/XV 950/R  
HARLEY DAVIDSON SPORTSTER:  
833 Roadster/Iron 833/Super Low/1200  
Custom/Forty-Eight/Seventy-Two  
HARLEY DAVIDSON DYNA:  
Low Rider/Wide Glide/Fat Bob/Street Bob  
HARLEY DAVIDSON STREET 750  
MOTO GUZZI V9 Roamer/Bobber

**Leather bag Rugged C-Bow**  
Weight: 2,1 kg Capacity: 21 Litres

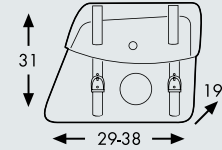

**Fits with**



**C-Bow holder**

**Leather bag Rugged Cutout**  
Weight: 2,1 kg Capacity: 19 Litres

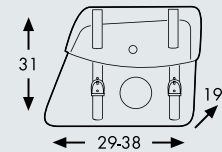

**Fits with**



**Cutout holder**

**Accessories, such as inner bags, rain hoods and spare parts, Leather care see page 139**

**More products Rugged series:**

**LEGACY REAR BAG - see page 133**  
**RUGGED SMALLBAG - see page 135**

# BUFFALO / BUFFALO CUSTOM / IVORY

Premium leather bags for your motorcycle



With their asymmetrical, dynamic, timeless look, these saddlebags enhance any chopper. The Buffalo leather collection is made of smooth pure 3-4 mm thick cowhide with matte black aniline dye throughout. Extra strong, tear-resistant seams for the best rigidity and long life. The bags hold their shape extremely well thanks to hidden reinforcements and a plastic double rear wall that eliminates drooping.

All of our leather bags are produced by us in our traditional leather craft shop with leather from European livestock, tanned according to the strictest environmental standards.



For Custom: chrome-plated brass rivets



Internal view leather bag  
Stability due to concealed shape and reinforcing parts



Noble, high-quality accessories

# BUFFALO



## Buffalo Big C-Bow

Item-no. 620250



## Buffalo Big

Item-no. 620240



## Buffalo C-Bow

Item-no. 620230



## Buffalo

Item-no. 620200



## Buffalo sandbrow C-Bow

Item-no. 620230 00 08



## Buffalo sandbrow

Item-no. 620200 00 08



Accessories, such as inner bags, rain hoods and spare parts, Leather care see page 139



Buffalo C-Bow



Buffalo Big C-Bow



INFO

### Leather bag Buffalo

Weight: 2,8 kg Capacity: 21 Litres

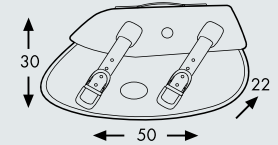

### Leather bag Buffalo Big

Weight: 3,5 kg Capacity: 27 Litres

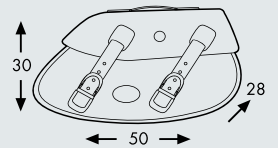

Fits with



Leather bag holder, tube type or C-Bow holder (depending on the design of the bag) Installation instruction see page 139

More products of Buffalo series:



HANDBAG/SMALLBAG - see page 135  
Tool roll - see page 131

# BUFFALO CUSTOM



## Buffalo Custom C-Bow

Item-no. 620235



## Buffalo Custom

Item-no. 620205



## Buffalo Custom Big C-Bow

Item-no. 620255

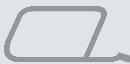

## Buffalo Big Custom

Item-no. 620245



Accessories, such as inner bags, rain hoods and spare parts, Leather care see page 139



Buffalo Custom C-Bow



Buffalo Big Custom C-Bow



## INFO

### Leather bag Buffalo Custom

Weight: 2,8 kg Capacity: 21 Litres

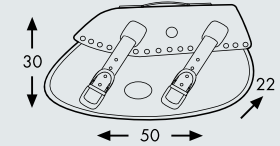

### Leather bag Buffalo Big Custom

Weight: 3,5 kg Capacity: 27 Litres

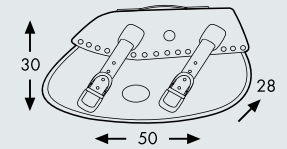

### Fits with



Leather bag holder, tube type or C-Bow holder  
(depending on the design of the bag)  
Installation instruction see page 140

### More products of Buffalo series:



HANDBAG/SMALLBAG - see page 135  
Tool roll - see page 131

# IVORY



**Ivory C-Bow**  
Item-no. 620510



**Ivory**  
Item-no. 620500



**Ivory black C-Bow**  
Item-no. 620515



**Ivory black**  
Item-no. 620505



Ivory C-Bow

## INFO

### Leather bag Ivory

Weight: 2,8 kg Capacity: 21 Litres

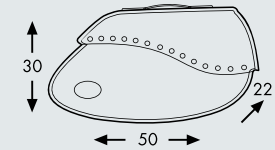

### Fits with



**Leather bag holder, tube type  
or C-Bow holder**  
(depending on the design of the bag)  
Installation instruction see page 139

**Accessories, such as inner bags, rain  
hoods and spare parts, Leather care**  
see page 143

### Leather fluid

The leather cleaning fluid increases longevity  
and weather resistance of the Legacy collection.



**Legacy leather fluid**  
Item-no. 7101975 00 01

# LIBERTY / NEVADA

Attractive leather collection to meet the highest standards



These high-quality premium leather bags have a timeless appearance and look fantastic anywhere. The Liberty leather collection is made of full-grained 3-4 mm thick bull leather with matte black aniline dye throughout. Extra strong, tear-resistant seams for the best stability and long life. The bags hold their shape extremely well and have hidden shape reinforcements and a plastic double rear wall. Rugged locks and corrosion-protected accessories are a given. All of our leather bags are produced especially for us in our traditional leather craft shop with leather from European livestock, tanned according to the strictest environmental standards.



Noble, high-quality accessories and leather



Full-grain, matt black bull leather, 3-4 mm. Integrated lock



Elegant, premium accessories



# LIBERTY



## Liberty C-Bow

Item-no. 620985



## Liberty

Item-no. 620980



## Liberty Big C-Bow

Item-no. 620986



## Liberty Big

Item-no. 620981



Accessories, such as inner bags, rain hoods and spare parts, Leather care see page 139



Liberty C-Bow



Liberty Big C-Bow



## INFO

### Leather bag Liberty

Weight: 2,3 kg Capacity: 21 Litres

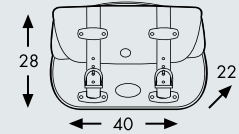

### Leather bag Liberty Big

Weight: 2,9 kg Capacity: 23 Litres

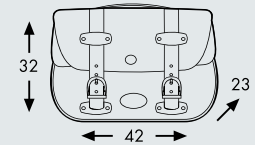

### Fits with



Leather bag holder, tube type or C-Bow holder  
(depending on the design of the bag)  
Installation instruction see page 140

### More products of Liberty series:



Smallbag - see page 135  
Tool roll - see page 131

# NEVADA

A bag that that boasts a different design; Nevada focuses on what is important. No rivets, no shells, and no off-beat design elements! The Nevada has a refreshingly restrained design – without giving up what is necessary in a full-fledged leather bag. The bags hold their form extremely well and have hidden reinforcements and a plastic double wall. This means no drooping, no fluttering and a solid hold to the carrier system. All of our leather bags are produced by us in our traditional leather craft shop with leather from European livestock, tanned according to the strictest environmental standards.



SUZUKI M800 Intruder

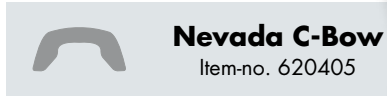

INFO

**Leather bag Nevada**  
Weight: 1,8 kg Capacity: 23 Litres

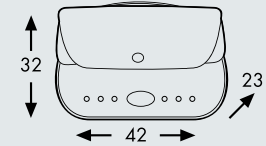

**Fits with**



**Leather bag holder, tube type  
or C-Bow holder**  
(depending on the design of the bag)  
Installation instruction see page 140

**Accessories, such as inner bags, rain hoods and spare parts, Leather care see page 139**

## Leather fluid

The leather cleaning fluid increases longevity and weather resistance of the Legacy collection.



**Legacy leather fluid**  
Item-no. 7101975 00 01



Nevada C-Bow

**HEPCO & BECKER**

# BUFFALO / CUSTOM / LIBERTY

## Leather tool rolls



**Tool roll Buffalo**  
Item-no. 620800



**Tool roll Buffalo Custom**  
Item-no. 620850



**Tool roll Liberty**  
Item-no. 620900



For tools or other utensils



For individual attachment to fork bars thanks to supplied straps.



Tool roll Buffalo  
HARLEY DAVIDSON Dyna Wide Glide

## INFO

### Tool roll

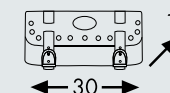

**For individual attachment to fork bars**

### LEATHER TOOL ROLLS

The best accessory to add a unique touch to your Chopper: high-quality tool bags made entirely of leather.

Traditionally crafted in our leather factory with sturdy buckles and metal logo. With straps for attachment to the fork bars.

### BUFFALO / BUFFALO CUSTOM:

made of smooth 3-4 mm full cowhide leather, custom version with chrome-plated brass rivets.

### LIBERTY:

made of full-grain 3-4 mm bull leather



**More leather products:**  
**LEATHER BAGS - page 124**  
**HANDBAGS - page 134**

# LEGACY

## Tool bags

since 1975  
**LEGACY**  
 by HEPSCO & BECKER

### LEGACY TOOL BAG

Made of heavy duty linen, several sewn in layers with a permanent water-repelling coating. Finished with contrasting, naturally tanned full cowhide leather. The quality of workmanship, craftsmanship and choice of materials are the hallmarks of our Legacy line.

### LEGACY LEATHER BAG

A small high-quality tool bag for individual fixing to the motorcycle.



### Legacy Tool bag

Item-no. 6451975 00 08 T green  
 Item-no. 6451975 00 01 T black

### Legacy Leather bag

Item-no. 6451975 00 08 W



For individual attachment to fork bars thanks to supplied straps.



For tools or other essentials



For individual attachment to the motorcycle. There are four mounting holes in the rear panel.

## INFO

### LEGACY Tool bag

Capacity: 2,5 Litres

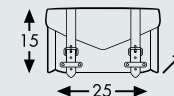

For individual attachment to fork bars

### LEGACY Leather bag

Capacity: 2 Litres



for individual fixing



Shoulder strap Item-no. 7401975 00 01  
 Leather fluid 100ml Item-no. 7101975 00 01

# LEGACY LEATHER

## Rear bags

since 1975  
**LEGACY**  
 by HEPACO & BECKER

The rear leather bag is now available to match the retro series. The Legacy Rear leather bag is available in sand brown and black, as well as in the „Rugged“ look. Made of 3 mm thick robust leather providing sturdy and rigid inner lining. Featuring two surrounding fastening straps, the bag is the ideal fit for tubular rear racks. Such as those offered for the new BMW R nineT models. This makes it easy and safe to attach. The universal and practical rear bag can also be attached to Sissybars and Soloracks. Ideal for small belongings. With Legacy logo embossing.



**Legacy leather rear bag**  
 Item-no. 6451975 00 08 R brown

Item-no. 6451975 00 18 R rugged

Item-no. 6451975 00 19 R sandbrown

Item-no. 6451975 00 01 R black

INFO

### Legacy leather rear bag

Capacity: 4 Litres

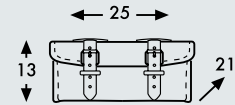

### Fits with



**Rear rack tube type / Soloracks**



**Legacy leather fluid**  
 Item-no. 7101975 00 01

### More products of Legacy leather series:



**BRIEFCASE - see page 121**



Especially for rear racks tube type



Strap attachment to rear rack tube type



Interior panelling and bracing

# RUGGED CHEST LEATHER CASE

Rugged Chest leather case – your rugged companion with character

Genuine, honest, and unique – this leather case is like a good friend. The treasure chest made of 3.5 mm thick cowhide leather for choppers and cruisers can definitely do more than just a regular luggage bag. It is a piece of individuality for your bike – and also equipped with many useful functions. It offers enough space for your helmet and can be locked with an integrated lock. The overlapping lid protects the inside from splashing water. As befits an authentic case, it has no zips, but rustic flaps, seams and loops. Angular, square or striking? Retro or new? It is not advisable to pigeon-hole the Rugged Chest leather suitcase. It is the way it is – and that is exactly what makes it perfect.

The tail bag is available in two mounting versions:

## 1. For individual mounting:

Includes quick lock for mounting to almost any rear rack. The quick locks are fastened by the customer. The fastener set and instructions are included.

Item-no. 620357 00 01

## 2. Pre-assembled and ready to use:

for Aluracks

Item-no. 620359 00 01

for Easyracks

Item-no. 620360 00 01

for rear racks, tube type\*

Item-no. 620358 00 01

\*Please indicate the article number of the mounted tubular luggage rack.



## Rugged Chest

For individual mounting

Item-no. 620357 00 01

For Easy-/Alurack or rear rack

Item-no. see left



Robust, 3.5 mm thick cowhide leather



Space for a helmet  
Splash-proof due to overlapping lid

INFO

## Rugged Chest leather case

Weight: 5 kg

Capacity: 30 Litres

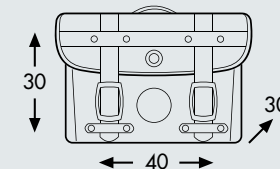

Fits with



Easyrack / Alurack /  
Rear rack tube type

Inner bag  
Item-no. 700510

Rain hood  
Item-no. 700439

More products of Leather series:



Leather bag Rugged - see page 122

# SMALLBAGS LIBERTY/ RUGGED



**Smallbag Liberty**  
Item-no. 620991



**Smallbag Rugged**  
Item-no. 620356 00 08 brown

**Smallbag Rugged black**  
Item-no. 620356 00 01black

## INFO

**Smallbag Rugged  
Smallbag Liberty**  
Weight: 3,1 kg  
Capacity: 19 Litres

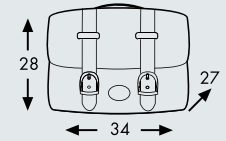

**Fits with**



**Rear racks / Sissybar  
with rear rack**

NOTE:  
Includes quick lock for mounting the small bag to almost any Sissybar or rear rack made of steel tubing. The quick locks are fastened by the customer. For this it is necessary to have the quick lock system brackets for mounting on the Smallbags. The fastener set and instructions are included.



Example Rugged brown: Special surface in used look. Embossed logo



Noble, high-quality accessories and leather



All handbags with lock  
Stability due to concealed shape

**Accessories and Spare parts  
see page 139**

**More products of Leather series:**



**Leather bag Rugged - see page 122**  
**Leather bag Liberty - see page 128**

# SMALLBAGS BUFFALO / BUFFALO CUSTOM



**Smallbag Buffalo**  
Item-no. 620225



**Smallbag Buffalo Custom**  
Item-no. 620220



All handbags with lock  
Stability due to concealed shape



Noble, high-quality accessories and leather



**Legacy leather fluid**  
Item-no. 7101975 00 01

## INFO

**Smallbag Buffalo**  
**Smallbag Buffalo Custom**  
Weight: 3,1 kg  
Capacity: 19 Litres

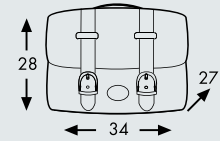

**Fits with**



**Rear racks / Sissybar  
with rear rack**

### NOTE:

Includes quick lock for mounting the small bag to almost any Sissybar or rear rack made of steel tubing. The quick locks are fastened by the customer. For this it is necessary to have the quick lock system brackets for mounting on the Smallbags. The fastener set and instructions are included.

**Accessories and Spare parts  
see page 139**

**More products of Buffalo series:**



**Leather bag Buffalo - see page 124**  
**Tool roll Buffalo - see page 131**



# HANDBAGS BUFFALO / BUFFALO CUSTOM



**Handbag Buffalo**  
Item-no. 620210



**Handbag Buffalo Custom**  
Item-no. 620215

**INFO**

**Handbag Buffalo**  
**Handbag Buffalo Custom**  
Weight: 4,9 kg  
Capacity: 33 Litres

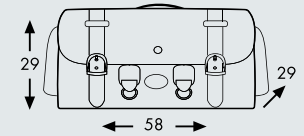

**Fits with**



**Rear racks / Sissybar  
with rear rack**

**Accessories and Spare parts  
see page 139**



Rear equipped with various lashing eyes

Secure attachment of our handbags to  
Sissybars and rear racks.  
Incl. material for mounting.



**Handbag enlargement**  
Item-no. 800000 00 09



Internal view Buffalo/Custom Handbag

**More products of Buffalo series:**



**Leather bag Buffalo - see page 124**  
**Tool roll Buffalo - see page 131**

# HANDBAGS LIBERTY



**Handbag Liberty Solorack**  
Item-no. 620995



**Handbag Liberty**  
Item-no. 620990



This Liberty Handbag Solorack has been developed especially for the Hepco&Becker Soloracks and is attached lengthwise.

Secure attachment of our handbags to Sissybars and rear racks. Incl. material for mounting.



**Handbag enlargement**  
Item-no. 800000 00 09



Internal view Handbag Liberty

## INFO

**Handbag Liberty Solorack**  
Weight: 4,1 kg Capacity: 26 Litres

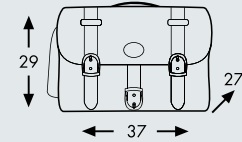

**Fits with**



**Soloracks**

**Handbag Liberty**  
Weight: 4,1 kg Capacity: 28 Litres

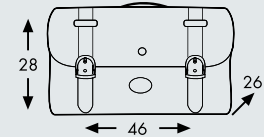

**Fits with**



**Rear racks**  
**Sissybar with rear rack**

**Accessories and Spare parts**  
see page 139

**More products of Liberty series:**

**Liberty Tool roll - see page 131**  
**Leather bag Liberty - see page 128**

# ACCESSORIES FOR LEATHER BAGS

## Legacy belt



Legacy belt black  
Item-no. 4201975 00 01

Legacy belt brown  
Item-no. 4201975 00 08

A high-quality leather belt with Hepco&Becker belt buckle and classy embossed logo. We only use premium accessories and naturally tanned leather.

## Shoulder strap Leather fluid



Legacy shoulder strap  
Item-no. 7401975 00 01

Very practical, turns the leather briefcase into a shoulder bag. With legacy logo embossing.

Legacy leather fluid  
Item-no. 7101975 00 01

The leather cleaning fluid increases longevity and weather resistance of the Legacy collection.

## Inner bags



for Buffalo / Buffalo Custom / Ivory  
Item-no. 700408

for Buffalo Big / Buffalo Big Custom  
Item-no. 700431

for Liberty / Liberty Big  
Item-no. 700405

for Rugged  
Item-no. 700433

for Rugged Chest  
Item-no. 700510

With this inner bag, nothing scatters around the saddle bag and everything stays in place. The saddle bag is easier to load, because the inner bag can be packed ahead of time. The bag is made of heavy duty black fabric. Equipped with a base plate, a 2-way zipper and an adjustable carrying strap, everything stays neat, even during unpacking.

## Rain hoods



for Buffalo / Buffalo Custom / Ivory  
Item-no. 700407

for Buffalo Big / Buffalo Big Custom  
Item-no. 700430

for Handbag Buffalo / Buffalo Custom  
Item-no. 700412

for Smallbag Buffalo / Buffalo Custom / Liberty / Rugged  
Item-no. 700414

for Liberty / Liberty Big / Nevada  
Item-no. 700406

for Rugged  
Item-no. 700434

for Handbag Liberty  
Item-no. 700413

Our leather bags are water-repellent in daily use. However, 100% water-proofing is not guaranteed. This is where the rain hood helps and protects the leather bag and the capacity.

## Spare parts Liberty/Nevada/Buffalo/Ivory



## Description

## Item-no.

- |  |            |
|--|------------|
| 1. Key*  | 710110-xx* |
| 2. Cylinder with 1 key*                                | 710142-xx* |
| 3. Metal emblem Hepco&Becker with revets               | 710099     |
| 4. Buckle Hepco&Becker with revets                     | 710100     |
| 5. Mounting Kit  | 700429     |
| 6. Retaining claw big, Set with fixation material      | 710119     |
| 7. Folding-lever for quick lock                        | 710101     |
| 8. Retaining claw small                                | 710123     |
| 9. 4x Clearance limitation plug with fixation material | 710122     |
| <b>For LIBERTY / NEVADA</b>                            |            |
| 10. Lid lock / Lock counterpart, complete set*         | 710140-xx* |
| <b>For BUFFALO IVORY</b>                               |            |
| 11. Lid lock / Lock counterpart, complete set*         | 710141-xx* |

\*indicate key number

# NOTICE FOR LEATHER BAGS

Leather bags are available in different versions and equipment. To help you choose, we present the possibilities here.

## HOME INSTALLATION

### Leather bag for leather bag holder – optional with holding clamps

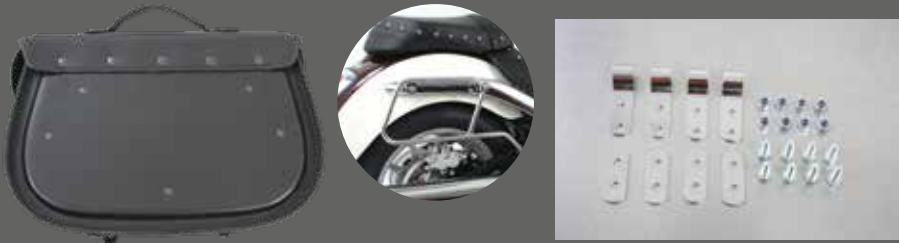

Designed for home installation with a fastening set for attachment to the bag holder (leather bags cannot be removed). This requires holes to be drilled in the back wall of the leather bag.

NOTE: The leather bag matches only the bag holder it is attached to. Once the holding clamps are installed, a leather bag can no longer be changed.

**Holding clamps, for self-assembly**  
Item-no. 700429

## FACTORY INSTALLATION

### Leather bag for leather bag holder-optional with quick lock installed at the factory

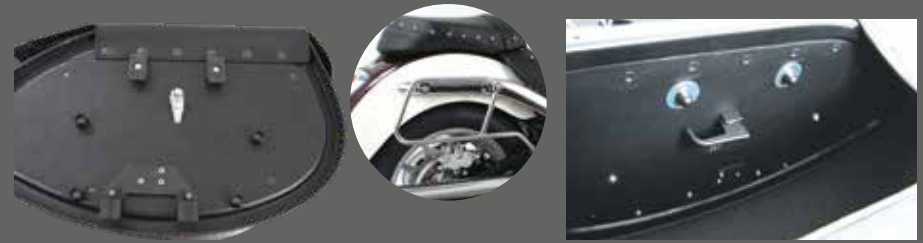

Another option when using a bag holder is our factory-installed quick lock. It allows the leather bag to be removed from the bag holder at any time. The lock also locks inside the bag to deter theft. The leather bag and bag holder are ordered together and installed in pairs.

NOTE: The leather bag matches only the bag holder it is attached to. Once the quick locks are installed, a leather bag can no longer be changed.

**Quick lock, factory fitted**  
Item-no. 700402

### Leather bag for leather bag holder – optional with quick lock

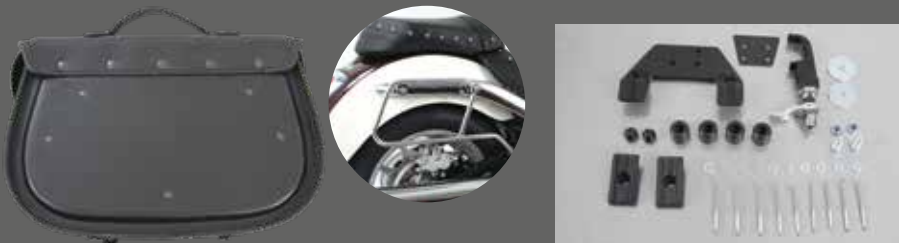

Another option when using a bag holder is our quick lock at additional charge for home assembly. This allows the leather bag to be removed from the bag holder at any time. Moreover, the lock works from inside the bag, securing the bag from theft. Home installation is very complex.

NOTE: The leather bag matches only the bag holder it is attached to. Once the quick locks are installed, a leather bag can no longer be changed.

**Quick lock, for self-assembly**  
Item-no. 700403

### C-Bow leather bags for C-Bow holder



We recommend the leather bag's C-Bow version (if a C-Bow leather bag holder is offered for your motorcycle). This requires no home installation and switching the model to a different motorcycle with C-Bow is no problem.

## CARRIER SYSTEMS

For more than 1000 motorcycle models

After choosing the case or bag, it's then a question of how to fasten them to the motorcycle. There are a variety of different attachment systems for this. On the following pages we present you with the luggage attachment possibilities. You can find out whether we also supply this for your motorcycle in the price list or keep up to date on the website.

We therefore provide different carriers not only for current models but also for youngtimers and motorcycles that are more than 30 years old. This has now exceeded 1000 models.

Hepco&Becker has premium side case carriers and side carriers in their range, exclusively for true classics. They manufacture products which not only impress when used but are also aesthetic and timeless.

For all of our carrier systems: these include the complete attachment kit with the necessary fittings and simple instructions.

For all products:

- Specially developed for the respective motorcycle model; universal parts available for particular solutions
- Cases and bags specially developed for HEPCO&BECKER
- Cases and bags from a single source
- No additional costs for additional adapters
- Metal tube made of forged German steel with high quality plastic coating, chrome plating or in stainless steel
- Comprehensive, simple instructions



## PROTECTION/ACCESSORIES

High quality components for your motorcycle

Globetrotters and touring riders have sworn by the products from Hepco&Becker for decades. In comparative tests carried out by trade press, we are regularly ranked the forerunners when assessing fitting accuracy, weather resistance and functionality during use; in short, it is an assessment of quality.

In addition to our extensive range for luggage transportation, we offer an abundance of other components which serve to optimise or protect and simultaneously visually enhance your machine: from lamp guards to under-body sealant - from side stand plates to centre stands. Standing securely on any ground.

Our new LED additional headlamps also apply to the topic of safety - see and be seen better.

All of our protective and accessory items include a complete attachment kit with the necessary fittings and simple instructions.

Suitable for DIY attachment. Your motorcycle dealer would be happy to help you on site.

For all products:

- Specially developed for the respective motorcycle model, universal parts available for particular solutions
- Mounting kits with fittings
- Metal tube made of forged German steel with high quality powder coating, chrome plating or in stainless steel
- Comprehensive, simple instructions

# LOCK-IT SYSTEM SIDE CARRIER

## The functional side carrier



BMW R 1250 GS

Outstanding fit – every carrier is adapted precisely to the motorcycle model. This means that the carrier fits the motorcycle exactly. During design, all model-specific characteristics are considered, such as the helmet and seat lock, turn signals, exhaust pipe height, etc.

Manufactured from steel tube, which is reinforced with a special inner tube at heavily strained places. A special feature of the Lock-It side carrier is the ability to remove them in seconds.

- Removal in seconds with Lock-It screws
- Theft deterrence available with Lock-It lock
- Motorcycle's look not disturbed by removed bracket; retaining tabs that remain are unobtrusive.

INFO

### Symbol



**Recommended load: 10 kg per side**  
Please follow the manufacturer's instructions

**Lock-It**  
HEPCO&BECKER

Effectively protects your removable Lock-It side case holder from theft. Just replace one of the Lock-It fastening screws on each side of the motorcycle with this lockable screw.

**Lockable Lock-it screw**  
Item-no.: 151050



### Matching side cases



**Possible restrictions**  
see motorbike model in price list

### It's so easy:



1. Losen the lower screw



2. Losen the upper screw



3. Remove the complete rack

# SIDE AND COMPLETE CARRIER FIRMLY BOLTED

## The sturdy side carrier

This type of side racks are firmly bolted to the motorcycle. Especially for Enduro-models, this is often the better choice compared to removable carrier systems when used in rough terrain.

A special form of the case carriers are the complete carrier, consisting of a side-mounted case carrier and a rear rack as a possible top case carrier. Both can only be mounted together.

Common to all versions is the solid construction made of precision steel tube, which is reinforced with a special inner tube at highly stressed areas.



HONDA CRF 1100 L Africa Twin



TRIUMPH Bonneville



BMW R 1300 GS



HONDA XL 750 Transalp

INFO

### Symbol

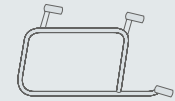

Recommended load: 10 kg per side  
Please follow the manufacturer's instructions

### Matching side cases



Possible restrictions  
see motorbike model in price list

# EASYRACK

## The support plate with foldable bracket for top case mounting



SUZUKI V-Strom 1000 ABS



HONDA CL 500



SUZUKI V-Strom 1050 DE



DUCATI Scrambler 1100 Pro

Easyracks are specially design as a carrier for our top cases while looking sleek and sporty even when riding without a top case. Here is why: The bow, required for attaching the top case, disappears when not in use by folding into the Easyrack. It no longer spoils the motorcycle's look. Even sitting on the motorcycle is easier when you can fold the bracket down. Every Easyrack is developed for the specific model and fits beautifully into the motorcycle's overall look. Production from premium aluminum gives the rack great strength and an elegant look. The rack design integrates additional luggage with belt fastening points for attaching luggage rolls, etc.

INFO

### Symbol

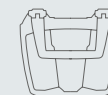

**Recommended load: 5 kg**  
**Please follow the manufacturer's instructions**  
**Can be combined with side carrier**  
**or C-Bow holder**  
**Not possible with**  
**Orbit TC 54, Alu Standard TC**  
**and universal top cases**

### Matching luggage



**Possible restrictions**  
**see motorbike model in price list**



# ALURACK

## The topcase carrier - functional and high-quality

Specific aluminium base plate in highest quality and beautiful finish - especially designed for our top cases. The bow, which can be used to mount the top case, can be removed, but not folded in, as with the Easyrack.

Every Alurack is developed for the specific model. Production from premium aluminum gives the aluminum rack great strength and an elegant look. The rack design integrates additional luggage belt fastening points for attaching luggage rolls, etc.



SUZUKI V-Strom 1050 DE



BMW S 1000 XR



APRILIA Tuareg 660



HONDA XL 750 Transalp

INFO

Symbol



**Recommended load: 5 kg**  
Please follow the manufacturer's instructions

**Can be combined with side carrier  
or C-Bow holder**

Matching luggage



**Possible restrictions**  
see motorbike model in price list

# REAR RACK - TUBE CONSTRUCTION - WITH BOW

## For top case mounting



ROYAL ENFIELD Continental GT 650

This rack variant enhances every classic and retro designed motorbike. Specially developed for every motorcycle, the rack is compatible with all top cases. Whether aluminium or plastic top case the fastening is simple and proven. Every rack is specially developed and produced for the corresponding motorcycle. High-quality German steel construction gives Hepco&Becker rear racks high strength and outstanding security. The premium metal coating maintains its look for a long time.



ROYAL ENFIELD Continental GT 650



TRIUMPH Bonneville Speedmaster



MOTO GUZZI V9 Roamer



HONDA CB750 Four

## INFO

### Symbol



**Recommended load: 5 kg**  
Please follow the manufacturer's instructions

Can be combined with C-Bow holder

### Matching luggage



**Possible restrictions**  
see motorbike model in price list

# REAR RACK - TUBE CONSTRUCTION - WITHOUT BOW

## Fits for rear bags

This rack variant is ideal for accommodating rear bags made of fabric or leather. It is delicate, extremely stable, and individually designed to match the shape of the rear end of the motorcycle. Thanks to the additional eyelet, it is possible to tie down bags or bags securely.

INFO

### Symbol



**Recommended load: 5 kg**  
Please follow the manufacturer's instructions

**Can be combined with C-Bow holder**  
**Not suitable for top case**



BMW R nineT



HONDA CL 500



DUCATI Scrambler Desert Sled



KAWASAKI W 800 Street/Café



HONDA ST 125 Dax

### Matching luggage



**Possible restrictions**  
see motorbike model in price list

# MINIRACK

## The slim plate for soft luggage

The slim, light, unobtrusive luggage solution specially made for small, sporty vehicles.

Slits in the edges and additional holding points make the mini rack ideal for safely transporting smaller luggage – a real eye catcher even without baggage. It is manufactured individually for each motorcycle model and therefore also varies in size and shape.

INFO

Symbol



**Recommended load: 5 kg**  
**Please follow the manufacturer's instructions**  
**Can be combined with side carrier**  
**or C-Bow holder**  
**Not suitable for top case**



BMW R 1200 GS Special shape



SUZUKI GSX-8S



MOTO GUZZI V100

## MATCHING LUGGAGE

Small Sport  
Star Rack



For all Miniracks

Street  
Daypack 2.0



Only for Miniracks with holes to hold the Lock-it or Basic rear bag attachment  
 Possible restrictions see motorcycle model in price list

Royster  
Daypack



Lock-it  
holder  
optional

Street  
Rearbag



Lock-it  
holder  
included

# ENLARGEMENT FOR REAR RACKS

## Luggage plate for soft luggage



Stable aluminum plate for extending almost any rear rack when loose luggage needs to be transported instead of top cases. Its raised edges and additional holding points make the extension ideal for carrying even larger luggage rolls, travel cases, tents duffels and more.

- Aluminum construction
- High strength, premium look
- Fastening options for luggage straps
- Available with attachment accessories
- Model-specific version or universal design for existing racks
- Deliverable in black and silver

Thanks to the identical hole pattern, the universal enlargement can be easily installed instead of existing Alu- or Easyracks. When used together with top loader side cases (e. g. Gobi, Xplorer) we recommend the small version of the extension.

SUZUKI V-Strom 1050



### Universal Enlargement small

Item-no. 610052 00 01 black  
Item-no. 610052 00 09 silver  
Dimension: 40/31 x 27 cm



### Universal Enlargement big

Item-no. 610053 00 01 black  
Item-no. 610053 00 09 silver  
Dimension: 48/39 x 28 cm



### H&B Belt set

2 straps, 25mm wide, 1,8 m long  
Item-no. 740012 black

INFO

### Symbol

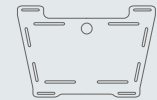

**Recommended load: 5 kg**  
**Please follow the manufacturer's instructions**  
**Can be combined with side carrier or C-Bow holder**  
**Not suitable for top case**



The universal enlargements are also available in silver and are supplied with fixing material.

### Matching luggage



**Possible restrictions**  
see motorbike model in price list

# C-BOW HOLDER BLACK

## Holder for Hepco&Becker C-Bow luggage



HONDA CB 750 Hornet



YAMAHA MT-09



ROYAL ENFIELD Super Meteor 650

The C-Bow is the perfect holder for side cases and bags. Its elegant, unobtrusive design fits perfectly into the bike's overall lines. It keeps the bags safely away from the hot exhaust muffler.

The C-Bow technology allows the bags to be attached simply and easily to the C-Bow with a single click, firmly locking them to deter theft.

The bags are attached securely to the motorcycle and stay in position even when loaded.

On many models, the turn signals stay in their original position.

### Horizontal or vertical installation

This improves the seating comfort of the pillion rider space, if a side pocket is mounted. See also Modellist



Accessories for C-Bow: C-Bow Shifting

## INFO

### Symbol



**Recommended load: 5 kg.**  
Please follow the manufacturer's instructions

**Can be combined with**  
Easy-/Alu-/Minirack  
Rear racks tube type

### Special accessories



**Canister C-Bow Set - see page 180**

### Matching luggage



**Also suitable for all Hepco&Becker leather bag holders C-Bow version, see page 140**

**Possible restrictions**  
see motorbike model in price list

# C-BOW HOLDER CHROME

## Holder for Hepco&Becker leather bags



TRIUMPH Bonneville Speedmaster

All Hepco&Becker leather bags in C-Bow version can be attached to the motorcycle with the help of a C-Bow holder.

Its elegant, unobtrusive design fits perfectly into the vehicle's overall lines and it keeps the bags safely away from the hot exhaust muffler.

The C-Bow technology allows the bags to be attached simply and easily to the C-Bow with a single click, firmly locking them to deter theft.

The bags are attached securely to the motorcycle and stay in position even when loaded.

On many models, the turn signals stay in their original position.



Easy to assemble. Secured against theft with lock on the C-Bow holder



YAMAHA XVS 950 A Midnight Star

### INFO

#### Symbol



**Recommended load: 5 kg.**  
**Please follow the manufacturer's instructions**

**Can be combined with**  
**Easy-/Alu-/Minirack**  
**Rear racks tube type**  
**Soloracks and Sissybars**

**For all Hepco&Becker C-Bow leather bags. Leather bags for leather bag holders tube type do not fit.**  
**SPECIAL NOTES on page 144**

#### Matching luggage



**Also suitable for all Hepco&Becker side bags in C-Bow design, see page 140**

**Possible restrictions**  
**see motorbike model in price list**

# LEATHER BAG HOLDER TUBE TYPE

## Tube type holder for Hepco&Becker leather bags



SUZUKI C 1800 R Intruder

Our timeless classic saddlebag holder is appealing for its beautiful design that perfectly matches the lines of the motorcycle.

The saddlebags always stay a safe distance from the hot exhaust and rear wheel. As they say: „As close as possible, as far as necessary.“ The rack is made of seamless steel tubing and features premium high-gloss chrome. Bags are easy to fasten; can be combined with a Sissybar or Solorack.



YAMAHA XVS 950 Midnight Star



SUZUKI C 1800 R Intruder



BMW R 1200 C

INFO

### Symbol

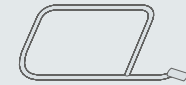

**Recommended load: 10 kg/side**  
**Please follow the manufacturer's instructions**

**Can be combined with**  
**Easy-/Alu-/Minirack**  
**Rear racks tube type/Soloracks/Sissybars**

**For all Hepco&Becker leather bags**  
**for leather bag holders tube type.**  
**C-Bow leather bags do not fit.**  
**SPECIAL NOTES on page 140**

### Matching luggage



**Possible restrictions**  
**see motorbike model in price list**



# LEATHER BAG HOLDER CUTOUT

## Holder for Hepco&Becker leather bag Rugged Cutout



MOTO GUZZI V9 Bobber/Roamer

This type of holder is offered for motorcycles with side shock absorbers. The overall narrow width adapts perfectly to the shape of the bike. The matching Rugged Cutout leather bag in brown or black has a cutout back panel that matches to the holder. To deter theft, this version can be attached from the inside of the bag, safe from sticky fingers.

- Solidly constructed, made of seamless steel tube black coated
- Tight fitting - recessed strut
- Firmly screwed to the motorcycle
- Simple assembly
- Indicators remain in original position



YAMAHA XV 950/R



YAMAHA SCR 950



HARLEY DAVIDSON Forty-Eight

### INFO

#### Symbol



**Recommended load: 5 kg/side**  
Please follow the manufacturer's instructions

**Rugged bag holder - special development for Rugged Cutout bags**

#### Special version



Canister C-Bow Set - see page 180

#### Matching luggage

**For Rugged Cutout leather bags only.**  
Leather bags for leather bag holders tube type or C-Bow holders do not fit.



**Possible restrictions**  
see motorbike model in price list

# LOCK-IT AND BASIC TANKRINGS

The technically perfect attachments for tank bags

## basic

Practical – functional

The new Basic system is not only a practical solution for attaching tank bags and tail bags, but also offers a valuable alternative to the well-tested Hepco&Becker Lock-it system. The Basic tank ring locks your luggage into place securely and reliably via the conic dome, allowing you to concentrate fully on the road – and all at an unbeatable price. It allows you to quickly and easily attach your luggage and remove it again without wasting any time or energy.

- available for over 450 motorcycle models
- safe and convenient attachment through mechanical locking on plastic domes
- enables fast and uncomplicated fuelling of your vehicle without tedious straps
- tank bag can be attached and released without any physical effort due to tensile straps
- can be combined with optional theft protection
- suitable for many Hepco&Becker tank bags



Underside of a tank bag with matching counterpart to the tank ring

## Lock-it

MagnetSystem  
FIDLOCK.com

Sophisticated – clever

Handling the tank bag has never been easier. The innovative Lock-it system makes attaching and removing the bag extremely easy. It saves you valuable time and enables you to quickly set off without any fiddling about.

One practical function of the Lock-it tank ring is the automatic centring. When putting on the tank bag, it is fastened magnetically and centred precisely. Sliding and shifting around is a thing of the past – you can enjoy a stable and secure attachment throughout the entire journey.

- available for over 450 motorcycle models
- easier centring function thanks to magnetic domes with mechanical load capacity of over 70 kg
- enables fast and uncomplicated fuelling of your vehicle without tedious straps
- tank bag can be attached and released without any physical effort due to tensile straps
- can be combined with optional theft protection
- suitable for many Hepco&Becker tank bags



KAWASAKI Z650 RS



HONDA Monkey 125



BMW R nineT



SUZUKI GSX-8S



HONDA XL 750 Transalp



BMW R 1300 GS

# LOCK-IT AND BASIC HOLDER

## Secure attachment for rear bags

### Matching bags



Holder optional



Holder included



Holder included

The principle of the tank ring is also applied when fixing our tail bags or day packs to sport and mini racks. A special Lock-it or Basic tail bag holder can be fitted to this rack.

For the Royster rear bag and the Street tail bag for sport racks, this tail bag holder is within the scope of delivery. We provide a retrofitting set for Royster and Street day packs. All options: see pages 148/158.

If you want to carry a Street or Royster Daypack as a rear bag on a Mini or Sportrack, a holder set is required. Incl. closure unit for mounting on the Daypack and holder for mounting on the Mini or Sportrack.

### Lock-it/Basic holder



### Fits with

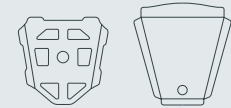

### Miniracks / Sportracks

Lock-it holder - Set  
Item-no. 506100

Basic holder - Set  
Item-no. 516100

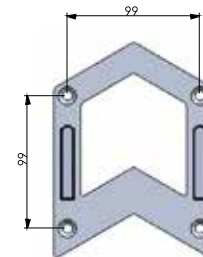

# UNIVERSAL TOP CASE FASTENING

## Secure attachment for top cases



Your motorcycle may already have a rear rack. If that is the case, why not mount a Hepco & Becker top case? There are universal mounts for those wanting this solution.

You have the following three options:

1. H&B Top case models including universal pallet: Due to the boring pattern, this enables mounting on existing rack constructions of the manufacturer. Pallet and mounting material are included in the kit. The following topcases are available as a universal version: Journey TC 30/40/50 as well as the Orbit TC 54.
2. Universal Alu/Easyrack or Rear rack tube type construction: universal solution for carrying every Hepco&Becker top case. These products must be mounted on existing base carriers.
3. An assembly of a universal rack is not possible: Then you will certainly find a specific solution in our model list.

INFO

### Symbol



Top case pallet + mounting material in the scope of delivery of these top cases

### Matching top case with pallet



Universal Alurack black  
Item-no. 610049 00 01 black



Universal Alurack silver  
Item-no. 610049 00 09 silver



Universal Easyrack black  
Item-no. 610100 00 01 black



Universal rear rack tube type  
Item-no. 610050 00 01 black

Not suitable for the top case  
ORBIT, ALU EXCLUSIV und ALU STANDARD.

# SPORTTRACK

## Carrier system for Soft Luggage

The problem of luggage transport on sporty motorcycles with short rear ends is well known: How and where can the luggage be reliably secured?

Hepco&Becker has the right solution for this: the Sportrack. This is simply clipped into place instead of the passenger seat and is therefore securely anchored by using the original motorcycle key. The seat bench can be exchanged for the Sportrack without any tools if necessary. A further advantage: The baggage is placed directly behind the driver in a streamlined and centre-of-centre-optimised position.



KAWASAKI Z1000 SX



KTM 1290 SUPER DUKE GT



Example with enlargement



DUCATI DesertX

### INFO

#### Symbol

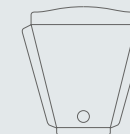

**Recommended load: 7,5 kg.**  
**Please follow the manufacturer's instructions.**

**Can be combined with C-Bow holder.**

**You will find an overview of the possibilities on the following pages.**



The substructure of each Sportrack is made of steel and galvanized for corrosion protection.

# SPORTRACK

## Overview of the possibilities

Each Sportrack has 4 additional holes that allow for luggage attachment - whether rear bags, enlargement or top case pallet. Furthermore, all sports racks have lashing slits which are conveniently designed for the individual attachment of bags or luggage rolls.

Small Sport Star Rack  
640012 00 00



Attachment with straps  
e.g. SPORT STAR RACK

Street Daypack 2.0  
640808 00 01



Adapter  
optional



Royster Daypack  
640813 00 07 yellow  
640813 00 01 black



Adapter  
optional

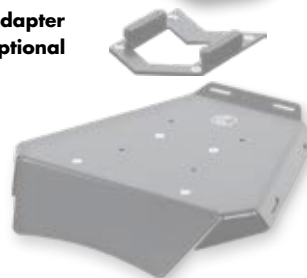

Street Rearbag Lock-it\*  
640806 00 01

Street Rearbag Basic\*  
640818 00 01



Adapter  
included



Royster Rearbag Sport Lock-it\*  
640814 00 01 black

Royster Rearbag Sport Basic\*  
640820 00 01 black



Adapter  
included



\* For the difference between Lock-it and Basic rear bag holders, see pages 154 and 155.

Attachment of luggage with the Lock-it or Basic adapter (mounting holes in the Sportrack available)  
e.g. DAYPACK / STREET REAR BAG / ROYSTER REAR BAG / ROYSTER REARBAG SPORT

## Overview of the possibilities

**Royster Rearbag Lock-it\***  
 640812 00 01 black  
 640812 00 07 yellow

**Royster Rearbag Basic\***  
 640819 00 01 black  
 640819 00 07 yellow

\* see pages 154 and 155.



Adapter  
 included

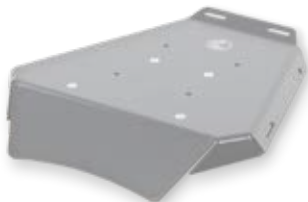

**Drybrid Bag 50**  
 640016 00 01

**Drybrid Bag 30**  
 640015 00 01



**Universal Enlargement big**  
 Item-no. 610053 00 01 black  
 Item-no. 610053 00 09 silver  
 Dimension: 48/39 x 28 cm

**Universal Enlargement small**  
 Item-no. 610052 00 01 black  
 Item-no. 610052 00 09 silver  
 Dimension: 40/31 x 27 cm

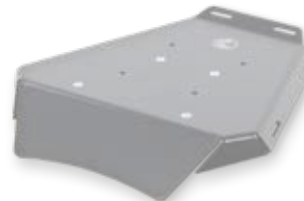

**Journey TC 50 silver**  
 610087 00 09

**Journey TC 50 black**  
 610087 00 01

**Journey TC 40 silver**  
 610089 00 09

**Journey TC 40 black**  
 610089 00 01

**Journey TC 30**  
 610206 00 01



Pallet  
 included

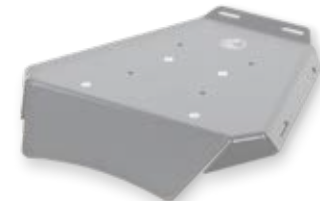

**Fastening of big luggage using an enlargement (mounting holes in each Sportrack) and belts e.g. PACKSACK / TRAVEL ZIP in different sizes or own luggage**

**Attachment of pallet top cases**  
 Not always possible. Possible restrictions see motorcycle model in price list

# SISSYBAR

## Stylish performance with and without rear rack



MOTO GUZZI V7 SPECIAL/STONE/CENTENARIO

Sissybar black with rear rack



MOTO GUZZI 1400 California

Sissybar chrome without rear rack



TRIUMPH Thunderbird 1600

Sissybar chrome with rear rack



MOTO GUZZI V9 Bobber

Sissybar black with rear rack

A gleaming appearance with or without a rear rack. This look is distinctive to a chopper.

Always comfortable on the road!

All components are chromed, polished to a high gloss or powder coated black and perfectly adapted to the character of your bike.

With the comfortable backrest, the passenger can relax and feel secure while riding. A sissybar with a rear rack makes it easy to carry small luggage.

Secure attachment of our handbags to Sissybars and rear racks.  
Incl. fixing material for mounting.



**Handbag Enlargement**  
Item-no. 800000 00 09

INFO

### Symbol



**Recommended load: 5 kg.**  
Please follow the manufacturer's instructions

**Top case mounting not possible.**  
Our Sissybars can be combined with leather bag holders and C-Bow holders

**Due to the size of handbags, we recommend the use of our handbag extension**

### Matching luggage



**Possible restrictions**  
see motorbike model in price list



# SOLORACK

Stylish performance with and without backrest

A guaranteed relaxed ride – on motorcycles with a divided seat. The passenger seat is replaced with one of these fantastic solo racks with or without a backrest. Available for many models. A solo rack makes it easy to take small luggage with you and fasten it securely. Our product line also includes an attractive Solorack handheld bag (Liberty solo rack handheld bag, Item No. 620995) made to our quality standards – the perfect addition.

INFO

Symbol



**Recommended load: 5 kg.**  
Please follow the manufacturer's instructions

**Top case mounting not possible.**  
Our Soloracks can be combined with leather bag holders and C-Bow holders



INDIAN SCOUT BOBBER / SIXTY / TWENTY

Solorack with back rest



YAMAHA XVS 650 Drag Star

Solorack without back rest



YAMAHA XV 950/R

Solorack black with back rest



SUZUKI M800 Intruder

Solorack with Liberty Handbag for Solorack

Matching luggage



**Possible restrictions**  
see motorbike model in price list

# PROTECTION BARS

## Engine and Tank guards - powder-coated



TRIUMPH Tiger 900 RALLY / GT / PRO



MOTO GUZZI V85



HONDA CL 500

Whether you ride more on rugged terrain, on country roads or in town, a Hepco & Becker guard is always the right choice. Your motorcycle is always effectively protected against an unexpected mishap. And even more: If the bike falls over or makes unintentional contact with the ground, it can protect both bike and rider from more serious consequences.

Hepco & Becker protection bars follow the lines of the bike perfectly, giving it a customized appearance. Made with extremely stable tube-in-tube construction. In addition, a protection bar is always a sensible purchase to avoid cost-intensive repairs, such as the replacement of fairing parts or motor housings. They also serve as a lashing point when loading the motorcycle. Thanks to the extensive, easy-to-understand instructions, assembling is also possible for non-specialists.

- Protection during pushovers or falls; helps when tying down the motorcycle
- Vehicle-specific design for perfect match and easy installation
- Tough tube-in-tube construction
- Premium powder coating in black, silver, or anthracite depending on model
- Complete, straightforward instructions

NOTE: Tank guards cannot be assembled alone - some new models only (see pictures) Generally, only possible with the Hepco&Becker engine guard for the appropriate motorcycle model.



HONDA CB 750 Hornet



DUCATI Scrambler 1100 Pro

# PROTECTION BARS

Engine and Tank guards - powder-coated



HONDA XL 750 Transalp



HONDA CRF 1100 L Africa Twin



HUSQVARNA Norden 901



KTM 890 SMT



BMW R nineT



KAWASAKI Versys 650



APRILIA Tuareg 660

# PROTECTION BARS

Engine and Tank guards - powder-coated



SUZUKI V-Strom 1050 DE



DUCATI Multistrada V4 / S / S SPORT



TRIUMPH Tiger 800 XR/XRX



HONDA NT 1100



MOTO GUZZI V9 Bobber & Roamer



HONDA Crosstourer



DUCATI DesertX

# PROTECTION BARS

Engine and Tank guards - powder-coated



HONDA CB 500 X



YAMAHA Ténéré 700 Rally



Tank guard bag set V1



KTM 890 Adventure R



BMW R 1250 GS



BMW R 1250 GS/R/RS

Reinforcement bracket for engine guards



BMW R 1300 GS

## SLIDEPAD

The new HEPCO&BECKER slidepad – does what it's made for!



Thanks to their sleek design and look, the new slidepads are a stylish way to upgrade your motorcycle. They also protect the coated guard and the motorcycle in case of sporadic or grinding contact with the surface or the road. By reducing or preventing expensive damage to the motorcycle or saving you from potentially having to replace the guard, the slidepads make the crash guard even more effective.

The damping effect of the plastic with sudden forces in the event of a crash enables part of the impact energy to be captured and absorbed.

Only suitable for tank and engine guards with a tube diameter of 22 and 25 mm.

## BARS WITH PROTECTION PAD



Whether you spend most of your time riding over difficult terrain, on country roads or along city streets; a crash bar from Hepco&Becker is always the right choice. Your motorcycle will have effective protection against unexpected mishaps at all times.

But more than that: In the event of a fall or unintentional contact with the ground, you can protect the motorcycle and the rider from serious damage. The crash bars are equipped with a shock-absorbing element with additional protection pads that can absorb energy to minimize damage. The load is also eased on the support and screw connection of the structure. In this specific version, a protection pad is integrated on each side to provide additional protection.

Available for your bike ?  
See model list



Slidepad set Item-no. 5070051

TRIUMPH Tiger Sport 660

HONDA NC 750 X

# PROTECTION BARS CHROME

Only the best for your motorcycle



TRIUMPH Thunderbird 1600



MOTO GUZZI V7 II / III



KAWASAKI VN 1600 classic

Our protection bars are tailored to the motorcycle and give them an individual character. Additionally, the motorcycle is protected against smaller accidents and ground contact, the bars protect the bike and the driver from bigger damage. The engine guards are made of polished, high shine chrome steel pipes. Using a pipe-in-pipe construction for better stability, every bar is developed for the specific bike and guarantees a perfect fit. The chrome prevents rust if taken care of properly. All guards are delivered with the necessary fixing material and simple mounting instructions.

Available for your bike ?  
See model list



HEPCO&BECKER

*Classic*  
SINCE 1975

HONDA CB 750 Four K1



YAMAHA XJR 1300



TRIUMPH Bonneville Speedmaster



ROYAL ENFIELD Continental GT 650

# PROTECTION BARS STAINLESS STEEL

Stainless steel electropolished - design and function



BMW R 1300 GS



YAMAHA Ténéré 700



HUSQVARNA Norden 901

With passion and commitment, we took on the challenge of stainless steel and fully mastered it.

Our stainless steel series offers you more ways to upgrade your motorcycle with Hepco & Becker products. Those who love stainless steel will make a great find among our cross-brand offerings, and will get a high-quality, very durable premium product. When it comes to protecting a motorcycle, stainless steel products have obvious advantages.

The blasted, electropolished surface ensures a visually and technically excellent finish, and makes the guard more resistant to rust. Your bike has an upgraded design, look and feel, and it is protected against damage to the fairing or engine. From an ecological point of view, stainless steel is much more environmentally friendly than other common materials, such as aluminum or carbon, and is even 100% recyclable.

Available for many models. Find what you are looking for in the catalogue model list! You will find more pictures on our website.



HONDA CRF 1100L Africa Twin Adventure Sports



BMW R 1200 GS LC / 1250 GS



# FRONT-/REAR PROTECTION BARS

For complete all-round protection



BMW F 900 R



HONDA CB 750 Hornet



HONDA CB 750 Hornet

For selected motorcycle models of the 125 to 850 class, which are frequently used in driving schools, we offer protection bars which protect the front or rear of the motorcycle. The protection bars offer good protection against falling even at low speeds and can be combined with the model-specific Hepco&Becker engine and tank guards. Depending on the motorcycle model, these are available in the coating colours black or anthracite. Very good stiffness values of the stirrups are achieved by increased wall thicknesses and the pipe-in-pipe construction.

- Provides protection in case of accidents and falls
- Turn signals, clutch and brake levers, mufflers, fairings, etc. are effectively protected, with limited pillion passenger
- Reinforced tube-in-tube construction, powder-coated



KAWASAKI Z650



YAMAHA MT-07



BMW F 750/850 GS



YAMAHA MT 125

# RAILING / PILLION HANDLE BAR

Practical and safe



BMW R nineT

If you can take a passenger, the bike must be equipped with an appropriate restraint system. A rail looks good too. The custom-fit production and easy mounting are a matter of course with a Hepco & Becker rail.

- Design specific to the model
- Custom-fit production, easy mounting
- Metal tube from a German steel forge with high-gloss chrome plating or a high-quality powder coating

Available for many models. Find what you are looking for in the catalogue model list! You will find more pictures on our website.



TRIUMPH 1200 Thruxton



KAWASAKI Z 900 RS - Cafe



KAWASAKI W 800 Street / Café



HONDA CB 500 Four



HONDA X-ADV



MOTO GUZZI V100

# HANDLE GUARD

## Protection for handlebars



BMW R 1300 GS

Whether riding on dirt or asphalt, the handlebar guard reliably protect the rider's hands and the motorcycle's handlebars. The appearance of the motorcycle is enhanced and the off-road look is underlined by its addition. The solid steel tube is 12 mm in diameter and coated in black. Suitable for heated grips

Note: Only fits vehicles with the original handlebar bracket !

Available for many models.  
Find what you are looking for in the catalogue model list!  
You will find more pictures on our website.



YAMAHA Ténéré 700



TRIUMPH TIGER 900 RALLY / GT / PRO



HONDA CRF 1000 L Africa Twin/Adventure Sports



DUCATI DesertX



HUSQVARNA Norden 901



MOTO GUZZI V85

# SKID PLATES

## Offroad protection



HONDA CRF 1000 L Africa Twin

Even a sidewalk can mean rough contact with the ground, and can damage the engine. This engine guard protects the manifolds and engine block from even the most violent ground contact or rock impact.

Hepco&Becker skid plates not only make your bike look great; they also enhance the off-road look and protect your bike.

- Effective protection against stone impact and obstacles during off-road use
- High-quality workmanship creates a visual highlight
- Made of high-strength aluminum, 3-4mm thick, depending on the model
- Precisely manufactured, adapted to fit the engine and exhaust system of each bike
- Complete mounting kit with fasteners, straightforward instructions

Available for your bike ? See Model list



HONDA XL 750 Transalp



TRIUMPH Tiger 900



HONDA Crosstourer



DUCATI Desert X



BMW R 1250 GS / Adventure



BMW F 750 / 850 GS

# HEADLIGHT GRILLES

Recommended for Offroad



YAMAHA Ténéré 700 World Raid



BMW R nineT / R nineT Urban GS



MOTO GUZZI V9 Bobber-Special Edition



HONDA Africa Twin Adventure Sports



APRILIA Tuareg 660



BMW R 1250 GS

A flying rock or short off-road trip can destroy an expensive headlight. Our headlight grille keeps the light protected and also adds an off-road look.

- Adapted to the design of the motorcycle
- Effective protection for the original headlight
- No reflections or danger of self-produced glare
- Easy installation with existing screw locations
- Rugged, coated metal construction

Available for many models. Find what you are looking for in the catalogue model list! You will find more pictures on our website.



HUSQVARNA Norden 901

# SUPPLEMENTARY PROTECTION

Optical upgrading paired with protection



YAMAHA SCR 950 / XV 950

Air filter box fender



HONDA CRF 1000 / 1100 L Africa Twin

Center stand protection plate



TRIUMPH Tiger Sport 660

Belly pan

For certain motorcycle models, we have individual components in our product range that protect selected parts and emphasize the look of the bike at the same time. Practical and high-quality manufactured they round off the other protection parts from Hepco&Becker.

Available for many models.  
Find what you are looking for in the catalogue model list!  
You will find more pictures on our website.



BMW R 1200 / 1250 GS

Kardan protection



HONDA NT 1100

Case guard



HARLEY-DAVIDSON PAN AMERICA / SPECIAL

Heat shield



HUSQVARNA Norden 901 / KTM 890 Adventure

Additional plate f. original skid plate

# FARI SUPPLEMENTARI NOVA LED

Set off on an evening adventure with the Nova led additional headlights

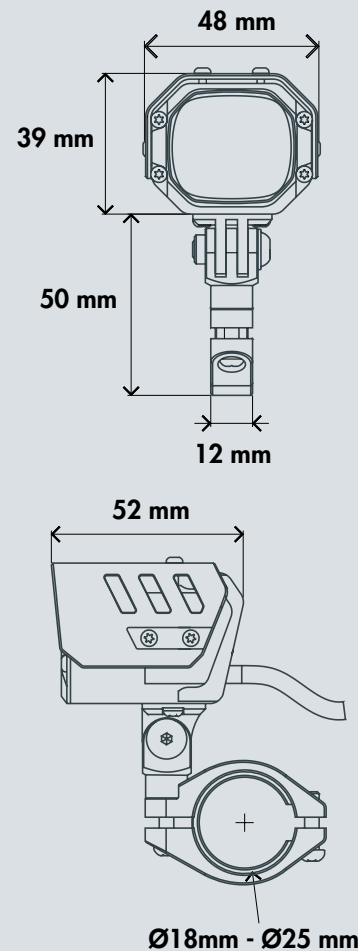

The provisions for attachment vary from country to country. Please inquire about the applicable legislation in your country.



**NOVA LED ADDITIONAL HEADLIGHTS (Set) Item-no. 731107**



Hanging mounting example (downwards)



Aluminium housing with protective screen

These additional headlights are fitted with a robust, powder-coated aluminium housing and offer two switching stages for different light intensities and colour temperatures. The universal attachment fits onto tubes with a diameter of 18 mm to 25 mm, either standing upwards or suspended downwards. Installation is easy and is done via battery, without any connection to the vehicle wiring harness.

A special control unit and illuminated switch protected against splashing water ensures that you remain in full control. Ready for every adventure, the Nova LED additional headlights are your faithful companion for breaking through the darkness and lighting up new horizons. Gear up for some exciting nights on the road!

#### DETAILS:

- Solid aluminium housing, powder-coated with protective screen
- Two switching stages at 2,500 lm
- Universal attachment to tube with diameters of 18 mm to 25 mm either standing (upwards) or suspended (downwards)
- Connected via battery, no connection to vehicle wiring harness required
- No external operation by third parties thanks to special control unit with automatic voltage control
- Illuminated switch protected against splashing water
- ECE-tested and approved
- Water- and dust-protected in line with IP67

# CENTER STANDS

For maintenance, fill-up, winter storage - simply practical



YAMAHA MT-09

Hepco & Becker center stands are extremely rugged and don't get in the way of your riding. The tension springs are made of stainless steel. Sophisticated geometry and anti-skid tread make it easy to stand your motorcycle securely in any situation. The precisely manufactured stands are very stable, sandblasted, black powder coated, and hold their value. Naturally, they're approved for the street. Center stands make maintenance easier and keep the bike stable, during fill-ups, for example. During winter storage, they take a load off the rear wheel. Available for your bike? See model list

Special tool for fitting the springs more easily

Special tool  
Item-no. 710134

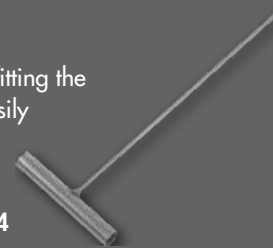

MOTO GUZZI V7 Special/Stone/Centenario



BMW F 650/700/800 GS



TRIUMPH Scrambler 1200 XC/XE



YAMAHA Ténéré 700



HONDA CRF 1000 L Africa Twin



KAWASAKI Versys 1000



# SIDE STAND ENLARGEMENT

## Secure stability



DUCATI DesertX



BMW R 1250 GS

Especially when fully packed or on uneven ground, the motorbike is easily at risk of sinking on the side stand. These precision-milled extension plates are quickly screwed to the side stands and eliminate this risk.

- More than 100% larger support surface
- Secure motorbike stability on all surfaces
- Black coated to protect against oxidation
- Adapted model specifically to original parts

Available for many models.  
Find what you are looking for in the catalogue model list!  
You will find more pictures on our website.



BMW R nineT pure

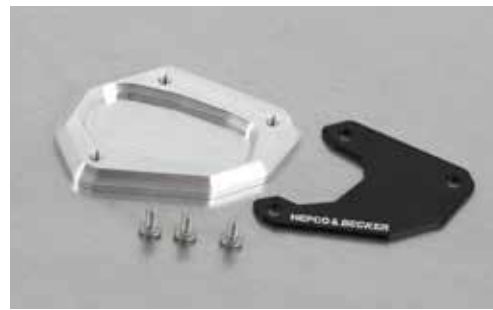

Scope of delivery incl. assembly instructions



KTM 790 Adventure



HONDA XL 750 Transalp

# FENDER GUARD

The rail for the front fender



HONDA VT 750 Shadow

The Hepco&Becker Fender Guards are a highlight to every motorcycle. The lines are adapted to the motorcycle's fender. Naturally, Hepco & Becker fender guards are precisely manufactured and easy to install.

- Custom designed for each bike
- Adapted to the lines of the motorcycle
- Precise manufacturing, easy assembly
- Quality german steel tubing
- Premium high-gloss chrome plating or black powder coating

Available for many models.  
Find what you are looking for in the catalogue model list!  
You will find more pictures on our website.



SUZUKI C 1800 R



YAMAHA XV 1600 Wild Star



HONDA X-ADV



MOTO GUZZI California



YAMAHA XVS 950 A Midnight Star



HONDA ST 125 Dax

# TWINLIGHTS

Depending on the bike model in the version



Twinlights Standard



or Twinlights Custom

Twinlights have high-gloss chrome plating and 55 watts of power each. They help any motorcycle make an imposing appearance. They don't just improve the looks of the motorcycles, but do double duty when it comes to safety. To see and be seen better is top priority.

- Better safety with two 55-watt lights
- A visual highlight
- Manufactured to precise tolerances
- Premium high-gloss chrome or black coated
- Easy to install, complete headlight set with two lights, a switch, wiring harness, relay, etc.
- Model-specific limited use with existing windscreens

Available for your bike ?  
See Model list



HONDA VT 750 Shadow



TRIUMPH Bonneville Speedmaster



SUZUKI C 1800 R



HARLEY DAVIDSON Dyna Wide Glide



MOTO GUZZI V7 III

# CANISTER SET

## Style and function



BMW R nineT

### Version for C-Bow holder

Art.no. 740007

Quick and easy to fit, the additional canister is a visual highlight for any motorbike and gives the machine that special military look. The high-quality coated steel canister is authentically and stylishly fixed to the base holder by means of tensioning material. The volume of the canister is 5 litres for the C-Bow version and 4 litres for the cutout version.

Incl. mounting material and tensioning strap. Delivery without model-specific holder.



INDIAN Scout Bobber / Sixty / Twenty

### Version for Leather bag holder Cutout

Art.no. see model price list

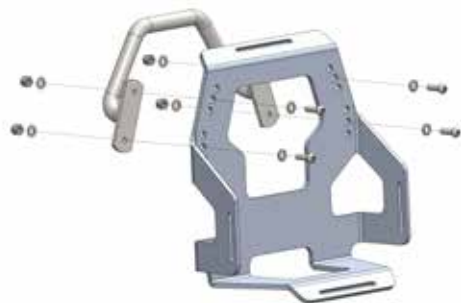

Mounting on C-Bow basic holder

See also page 150 and in the model list page 193



INDIAN Scout Bobber / Sixty / Twenty



Mounting on leather bag holder Cutout

See also page 153 and in the model list page 193



## **BIKE MODELS**

**HEPCO & BECKER**

## LUGAGGE

### SIDE CASE | TOP CASE

Xceed.....	183
Xplorer.....	184
Alu Standard.....	184
Gobi.....	185
Junior/Junior Flash.....	185
Orbit Topcase.....	186
Journey.....	186
Xcore.....	187
Orbit Sidecase.....	187
Strayker.....	187

### TANK BAGS

Legacy.....	190
Epic.....	188
Royster.....	187
Street.....	188
Legacy.....	190

### BAGS

Sport Star.....	189
Travel.....	189
Crash bar bag set V1.....	187
Legacy.....	190

### C-BOW SIDE BAGS

Royster.....	187
Street.....	188
Xtravel.....	189

### LEATHER BAGS

Legacy.....	190
Rugged.....	191
Liberty.....	191
Nevada.....	191

### REAR BAGS

Royster.....	187
Street.....	188
Xtravel.....	189
Drybrid.....	189
Buffalo.....	192
Buffalo Custom.....	192
Ivory.....	192

## MODELS

<b>A</b> APRILIA.....	196	<b>G</b> GENERIC.....	268	<b>L</b> LAVERDA.....	269	<b>R</b> ROYAL ENFIELD.....	270
<b>B</b> BENELLI.....	268	<b>H</b> HARLEY-DAVIDSON.....	213	<b>M</b> MALAGUTI.....	269	<b>S</b> SUZUKI.....	246
BMW.....	198	HONDA.....	214	MASH.....	269		
BUELL.....	268	HUSQVARNA.....	268	MONDIAL.....	269	<b>T</b> TRIUMPH.....	254
		HYOSUNG.....	269	MOTO GUZZI.....	241		
<b>C</b> CAGIVA.....	268			MOTO MORINI.....	269	<b>V</b> VICTORY.....	270
CF MOTO.....	268	<b>I</b> INDIAN.....	269	MV AGUSTA.....	269	VOGE.....	270
				MZ.....	269		
<b>D</b> DUCATI.....	210	<b>K</b> KAWASAKI.....	228	<b>P</b> PEUGEOT.....	269	<b>Y</b> YAMAHA.....	259
		KTM.....	237	PIAGGIO.....	269		
		KYMCO.....	269				

## OTHER ACCESSORIES

Special accessories.....	193	Spare parts.....	193	Universal accessories.....	194	Mounting instructions   Specific notes.....	271
--------------------------	-----	------------------	-----	----------------------------	-----	--	-----



Description	Item-no.	Info	Colours
<b>XCEED SIDE CASE TITAN</b>			
Alu case XCEED left	610222 00 00	38 l	Titan
Alu case XCEED right	610223 00 00	38 l	Titan



Description	Item-no.	Info	Colours
<b>XCEED SIDE CASE SILVER</b>			
Alu case XCEED left	610222 00 09	38 l	Aluminum
Alu case XCEED right	610223 00 09	38 l	Aluminum



Description	Item-no.	Info	Colours
<b>XCEED SIDE CASE JET BLACK</b>			
Alu case XCEED left	610222 00 01	38 l	black-bronze
Alu case XCEED right	610223 00 01	38 l	black-bronze



Description	Item-no.	Info	Colours
<b>XCEED SIDE CASE BLACK</b>			
Alu case XCEED left	610222 00 11	38 l	black
Alu case XCEED right	610223 00 11	38 l	black

Universal accessories f. alu cases: see page 195

<b>ACCESSORIES XCEED CASE</b>			
Inner bag	700523		black
Top bag	640006 00 01	11 l	black
Shoulder strap for case/top case	700401		black
Carrying handle for case	740016		black
Additional kit for Xceed case for mounting universal holder, drinking bottle holder & water canister	710127		



Description	Item-no.	Info	Colours
<b>XCEED TOP CASE TITAN</b>			
Alu top case XCEED	610224 00 00	45 l	Titan



Description	Item-no.	Info	Colours
<b>XCEED TOP CASE SILVER</b>			
Alu top case XCEED	610224 00 09	45 l	Aluminum



Description	Item-no.	Info	Colours
<b>XCEED TOP CASE JET BLACK</b>			
Alu top case XCEED	610224 00 01	45 l	black-bronze



Description	Item-no.	Info	Colours
<b>XCEED TOP CASE BLACK</b>			
Alu top case XCEED	610224 00 11	45 l	black

Universal accessories f. top case: see page 195

<b>ACCESSORIES XCEED TOP CASE</b>			
Inner bag	700524		black
Back rest	700315		black
Floor mate	710294		black

Spare parts see p. 33

Description	Item-no.	Info	Colours
<b>XPLORER SIDE CASE 30/40 SILVER</b>			
Alu case Xplorer 30 left	610208 00 00	33 l	Aluminum
Alu case Xplorer 30 right	610209 00 00	33 l	Aluminum
Alu case Xplorer 40 left	610210 00 00	42 l	Aluminum
Alu case Xplorer 40 right	610211 00 00	42 l	Aluminum



Description	Item-no.	Info	Colours
<b>XPLORER SIDE CASE 30/40 BLACK</b>			
Alu case Xplorer 30 left	610213 00 01	33 l	black
Alu case Xplorer 30 right	610214 00 01	33 l	black
Alu case Xplorer 40 left	610215 00 01	42 l	black
Alu case Xplorer 40 right	610216 00 01	42 l	black



Spare parts  
see p. 41

Description	Item-no.	Info	Colours
<b>XPLORER CUTOUT 37</b>			
Alu case Xplorer Cutout 37 left	610218 00 00	37 l	Aluminum
Alu case Xplorer Cutout 37 right	610219 00 00	37 l	Aluminum
Alu case Xplorer Cutout 40 left	610220 00 00	42 l	Aluminum
Alu case Xplorer Cutout 40 right	610221 00 00	42 l	Aluminum



Description	Item-no.	Info	Colours
<b>XPLORER CUTOUT 37/40 BLACK</b>			
Alu case Xplorer Cutout 37 left	610218 00 01	37 l	black
Alu case Xplorer Cutout 37 right	610219 00 01	37 l	black
Alu case Xplorer Cutout 40 left	610220 00 01	42 l	black
Alu case Xplorer Cutout 40 right	610221 00 01	42 l	black



**XPLORER  
CUTOUT SET**  
Bike specific  
- see model list

Universal  
accessories  
f. alu cases:  
see page 195

Description	Item-no.	Info	Colours
<b>ACCESSORIES XPLORER CASE</b>			
Inner bag for Xplorer 30	700513		black
Inner bag for Xplorer 40	700514		black
Inner bag for Xplorer 37 Cutout	700520		black
Top bag for lid Xplorer 30	640004 00 01	9-15 l	black
Top bag for lid Xplorer 40	640005 00 01	12-19 l	black
Shoulder strap for case/top case	700401		black
Carrying handle for case	740009		black
Locking device for offroad use	750002		black
Locking device for offroad use -Cutout	750003		black
Xplorer 30 Railing	610098 00 01		black
Xplorer 40 Railing	610099 00 01		black

Description	Item-no.	Info	Colours
<b>XPLORER TOP CASE 45/60 SILVER</b>			
Alu Xplorer TC 45	610212 00 00	45 l	Aluminum
Alu Xplorer TC 60	610225 00 00	58 l	Aluminum



Description	Item-no.	Info	Colours
<b>XPLORER TOP CASE 45/60 BLACK</b>			
Alu Xplorer TC 45	610217 00 01	45 l	black
Alu Xplorer TC 60	610225 00 01	58 l	black



Description	Item-no.	Info	Colours
<b>ACCESSORIES XPLORER TOP CASE 45/60</b>			
Inner bag TC 45	700515		black
Inner bag TC 60	700525		black
Back rest	700315		black
Railing	610093 00 01		black
Railing	610093 00 09		silver
Carrying handle TC 45	740014		black

Description	Item-no.	Info	Colours
<b>ALU STANDARD SIDE CASE 35/40</b>			
Alu Standard 35 left	610074 00 00	36 l	Aluminum
Alu Standard 35 right	610075 00 00	36 l	Aluminum
Alu Standard 40 left	610076 00 00	42 l	Aluminum
Alu Standard 40 right	610077 00 00	42 l	Aluminum
Inner bag Alu Standard 35	700508		black
Inner bag Alu Standard 40	700509		black



Spare parts  
see p. 49

Description	Item-no.	Info	Colours
<b>ACCESSORIES ALU STANDARD SIDE CASE 35/40</b>			
Locking device for offroad use	750007		black

Description	Item-no.	Info	Colours
<b>ALU STANDARD TOP CASE 35</b>			
Alu Standard TC 35	610073 00 00	35 l	Aluminum

**Note:** Mounting on Easyracks not possible!



Universal  
accessories  
f. top case:  
see page 195

Description	Item-no.	Info	Colours
<b>ACCESSORIES ALU STANDARD TOP CASE 35</b>			
Back rest	700315		black
Inner bag	700510		anthracite
Special bow for Alurack for the use with Alu Standard TC 35	700007350 700007351		black silver





Description	Item-no.	Info	Colours
<b>GOBI SIDE CASE 37 BLACK EDITION</b>			
Gobi Black Edition set incl. mounted strap loops	610288 00 01	31 l	black/silver

Spare parts  
see p. 55

<b>GOBI SIDE CASE 37 BLACK</b>			
Gobi Black set	610083 00 01	31 l	black

ACCESSORIES GOBI SIDE CASE			
Strap loops	700149		metal colour
Water tap	700148		
Inner bag	700508		black
Locking device for offroad use	750008		anthracite



<b>GOBI TOP CASE 42 BLACK EDITION</b>			
Gobi Black Edition TC 42	610289 00 01	38 l	black/silver

<b>GOBI TOP CASE 42 BLACK</b>			
Gobi Black TC 42	610084 00 01	38 l	black

ACCESSORIES GOBI TC 42			
Back rest	700312		black
Inner bag	700511		black



JUNIOR SIDE CASE 30/40			
Junior 30 set	610033 00 01	27 l	black
Junior 40 set	610036 00 01	37 l	black
Junior Enduro set 40/30 Junior 40 left / Junior 30 right	610037 00 01	37/27 l	black
Junior Enduro set 30/40 Junior 30 left / Junior 40 right	610038 00 01	27/37 l	black

Spare parts  
see p. 69



Spare parts  
see p. 69

Description	Item-no.	Info	Colours
<b>JUNIOR FLASH SIDE CASE 30/40</b>			
Junior 30 Flash set	610233 00 09	27 l	Cover silver
Junior 40 Flash set	610236 00 09	37 l	Cover silver
Junior 30 Flash set	610233 00 11	27 l	Cover black
Junior 40 Flash set	610236 00 11	37 l	Cover black
Junior Flash Enduro set 40/30 Junior 40 left/Junior 30 right	610237 00 09	37/27 l	Cover silver
Junior Flash Enduro set 40/30 Junior 40 left/Junior 30 right	610237 00 11	37/27 l	Cover black
Junior Flash Enduro set 30/40 Junior 30 left / Junior 40 right	610238 00 09	27/37 l	Cover silver
Junior Flash Enduro set 30/40 Junior 30 left / Junior 40 right	610238 00 11	27/37 l	Cover black

ACCESSORIES JUNIOR / JUNIOR FLASH SIDE CASE 30/40			
Inner bag left Junior 30	700506		black
Inner bag right Junior 30	700507		black
Inner bag left Junior 40	700501		black
Inner bag right Junior 40	700502		black



Spare parts  
see p. 79

<b>JUNIOR TOP CASE 40</b>			
Junior TC 40	610040 00 01	40 l	black

ACCESSORIES JUNIOR TC 40			
Railing	610055 00 01		black
Back rest	700303		black
Inner bag	700510		anthracite



<b>JUNIOR TOP CASE 55/55 FLASH</b>			
Junior TC 55	610047 00 01	55 l	black
Junior TC 55 Flash black	610047 00 11	55 l	Cover black
Junior TC 55 Flash silver	610047 00 09	55 l	Cover silver

ACCESSORIES JUNIOR TC 55/55 FLASH			
Railing	610051 00 01		black
Back rest	700320		black
Inner bag	700503		black
Floor mate	710216		black



Spare parts  
see p. 79

Description	Item-no.	Info	Colours
<b>ORBIT TOP CASE 54 incl. universal panel</b>			
Orbit TC 54	610290 00 01	54 l	black

**Note:** Can only be used with the Alurack or the special universal panel (included). Not possible with rear rack tube type or Easyrack.

**ACCESSORIES ORBIT TC 54**

Railing	610056 00 01		black
Back rest	700321		black
Inner bag	700503		black
Document bag	710049		black
Floor mate	710225		black



Spare parts  
see p. 69

**JOURNEY SIDE CASE 42**

Journey 42 set	610080 00 01	40 l	Cover silver
Journey 42 White set	610080 00 03	40 l	Cover white
Journey 42 Recon set	610280 00 04	40 l	Cover arctic
Journey 42 Black set	610280 00 11	40 l	Cover black

**ACCESSORIES JOURNEY SIDE CASE**

Inner bag	700503		black
-----------	--------	--	-------



**JOURNEY TOP CASE 30**

Journey TC 30 incl. universal pallett	610206 00 01	29 l	black
---------------------------------------	--------------	------	-------

**ACCESSORIES JOURNEY TC 30**

Back rest	700313		black
Reinforcement plate	710153		black



Spare parts  
see p. 78

**JOURNEY TOP CASE 40**

Journey TC 40	610088 00 01	35 l	black
Journey TC 40	610088 00 09	35 l	Cover silver
Journey TC 40 incl. universal pallett	610089 00 01	35 l	black
Journey TC 40 incl. universal pallett	610089 00 09	35 l	Cover silver

**ACCESSORIES JOURNEY TC 40**

Railing	610061 00 01		black
Back rest	700311		black
Inner bag	700510		black
Reinforcement plate f. universal TC40	710153		black



Spare parts  
see p. 69

**JOURNEY TOP CASE 42**

Journey TC 42	610085 00 01	40 l	Cover silver
Journey TC 42 White	610085 00 03	40 l	Cover white
Journey TC 42 Recon	610285 00 04	40 l	Cover arctic
Journey TC 42 Black	610285 00 11	40 l	Cover black

**ACCESSORIES JOURNEY TC 42**

Railing	610060 00 01		black
Back rest	700308		black
Inner bag	700503		black



**JOURNEY TOP CASE 50**

Journey TC 50	610086 00 01	49 l	black
Journey TC 50	610086 00 09	49 l	Cover silver
Journey TC 50 incl. universal pallett	610087 00 01	49 l	black
Journey TC 50 incl. universal pallett	610087 00 09	49 l	Cover silver

**ACCESSORIES JOURNEY TC 50**

Railing	610061 00 01		black
Back rest	700305		black
Inner bag	700503		black
Reinforcement plate f. universal TC50	710153		black



Spare parts  
see p. 78

**JOURNEY TOP CASE 52**

Journey TC 52 Recon	610207 00 04	52 l	Cover arctic
Journey TC 52 Black	610207 00 11	52 l	Cover black
Journey TC 52 Silver	610207 00 09	52 l	Cover silver

**ACCESSORIES JOURNEY TC 52**

Railing	610058 00 01		black
Back rest	700314		black
Inner bag	700503		black

## XCORE | ORBIT | STRAYKER C-BOW CASE

**NEW**



Description	Item-no.	Info	Colours
<b>XCORE SIDE CASE C-BOW</b>			For use with the C-Bow holder only
Xcore side case set	610295 00 00	18 l	black/silver
Xcore side case set	610295 00 01	18 l	black/black

Spare parts  
see p. 83



Description	Item-no.	Info	Colours
<b>ORBIT SIDE CASE C-BOW</b>			For use with the C-Bow holder only
Orbit Sidecase set	610293 00 01	15 l	black

Description	Item-no.	Info	Colours
<b>ACCESSORIES ORBIT SIDE CASE</b>			
Inner bag	700521		black



Description	Item-no.	Info	Colours
<b>STRAYKER 23 SIDE CASE</b>			
Strayker set incl. quick lock	620940 00 01	16 l	black

Description	Item-no.	Info	Colours
<b>STRAYKER 23 SIDE CASE C-BOW</b>			For use with the C-Bow holder only
Strayker C-Bow set	620945 00 01	16 l	black

Description	Item-no.	Info	Colours
<b>ACCESSORIES STRAYKER</b>			
Inner bag	700405		black
rain cover	700415		black

**NEW**



Description	Item-no.	Info	Colours
<b>ROYSER NEO SIDE BAG</b>			For use with the C-Bow holder only
Royster Neo C-Bow set	640622 00 01	16-17,5 l	grey
Royster Neo C-Bow set	640622 00 07	16-17,5 l	yellow

**NEW**



Description	Item-no.	Info	Colours
<b>ROYSER SPEED SIDE BAGS</b>			For use with the C-Bow holder only
Royster Speed C-Bow set	640624 00 01	13 l	grey
Royster Speed C-Bow set	640624 00 07	13 l	yellow



Description	Item-no.	Info	Colours
<b>ROYSER TANK BAGS</b>			For use with the Tankring only.
Royster Tankbag	640810 00 01	6-9 l	black
Royster Tankbag	640810 00 07	6-9 l	yellow
Royster Daypack	640813 00 01	5 l	grey
Royster Daypack	640813 00 07	5 l	yellow

## ROYSER BAGS | TANK BAGS

Description	Item-no.	Info	Colours
<b>ROYSER REARBAG</b>			As strap set or as Lock-it / Basic version.



Royster Rearbag incl. strap set	640811 00 01	17-19 l	grey
Royster Rearbag incl. strap set	640811 00 07	17-19 l	yellow
Royster Rearbag Lock-it*	640812 00 01	17-19 l	grey
Royster Rearbag Lock-it*	640812 00 07	17-19 l	yellow
Royster Rearbag Basic*	640819 00 01	17-19 l	grey
Royster Rearbag Basic*	640819 00 07	17-19 l	yellow

\*incl. rear bag holder Lock-it / Basic and strap set

Description	Item-no.	Info	Colours
<b>ROYSER REARBAG SPORT</b>			As strap set or as Lock-it / Basic version.



Royster Rearbag Sport incl. strap set	640814 00 01	11-15 l	grey
Royster Rearbag Sport* Lock-it	640815 00 01	11-15 l	grey
Royster Rearbag Sport* Basic	640820 00 01	11-15 l	grey

\*incl. rear bag holder Lock-it / Basic and strap set

Description	Item-no.	Info	Colours
<b>ACCESSORIES ROYSER TANK BAGS</b>			

Mobile phone bag (only Tankbag)	640809 00 01		black
Map bag (only Tankbag)	640807 00 01	DIN A4	black
Combination lock	7105590		black
Combination lock with Wire	7105591		black
Anti-theft protection	506300		
Locking device for a second tank bag (Tankring Lock-it already mounted)	506000		black
Locking device for a second tank bag (Tankring Basic already mounted)	516000		black
Device for rear bag holder Lock-it for Royster Daypack	506150		
Device for rear bag holder Basic for Royster Daypack	516150		
Rear bag holder Lock-it for the use of a Daypack on a Sportrack	506100		black
Rear bag holder Basic for the use of a Daypack on a Sportrack	516100		black

**NEW**



Description	Item-no.	Info	Colours
<b>EPIC TANK BAGS</b>			
For use with the Tankring only.			
Epic 3	640900 00 01	3 l	black
Epic 6	640901 00 01	6 l	black
Epic 11 Belt	640902 00 01	11 l	black
Epic 11	640905 00 01	11 l	black
Epic 13	640903 00 01	13 l	black
Epic 16	640904 00 01	16 l	black

### ACCESSORIES ROYSTER TANK BAGS

Mobile phone bag (only Tankbag)	640809 00 01		black
Map bag (only Tankbag)	640807 00 01	DIN A4	black
Combination lock	7105590		black
Combination lock with Wire	7105591		black
Anti-theft protection	506300		
Locking device for a second tank bag (Tankring Lock-it already mounted)	506000		black
Locking device for a second tank bag (Tankring Basic already mounted)	516000		black
Device for rear bag holder Basic for Epic 3 or 6	516150		
Rear bag holder Basic for the use of a Epic 3 or 6 on a Sportrack	516100		black

### STREET SIDE BAG

For use with the C-Bow holder only

Street C-Bow set	640602 00 01	16 l	black
Inner bag (Spare part)	700519	16 l	black

### STREET TANK BAGS

For use with the Tankring Lock-it Lock-it only

Tank bag Street Tourer L	640800 00 01	10-15 l	black
Tank bag Street Tourer M	640805 00 01	7-10 l	black
Tank bag Street Enduro M	640816 00 01	10-14 l	black
Tank bag Street Daypack 2.0	640808 00 01	4 l	black



Enduro M

Description	Item-no.	Info	Colours
<b>ACCESSORIES STREET DAYPACK 2.0</b>			
Mobile phone bag	640809 00 01		black
Map bag	640807 00 01	DIN A4	black
Lock-it rear bag holder for the use of a Daypack on a Sportrack	506100		black
Basic rear bag holder for the use of a Daypack on a Sportrack	516100		black
Device for Lock-it rear bag holder	506150		
Device for Basic rear bag holder	516150		

### STREET DAYPACK SMALL

For use without Tankring (magnetic fixation on metal tanks)

Street Daypack small	640804 00 01	2-3 l	black
----------------------	--------------	-------	-------



### STREET REAR BAG LOCK-IT

For Sportracks and Miniracks

Street rear bag Lock-it*	640806 01 01	7-10 l	black
Street rear bag Basic*	640818 00 01	7-10 l	black
Street rear bag incl. strap set	640817 00 01	7-10 l	black



\*incl. rear bag holder Lock-it and strap set

### ACCESSORIES TANK BAGS AND REAR BAGS

Combination lock	7105590		black
Combination lock with Wire	7105591		black
Anti-theft protection (only for Tank bags and Rear bags with Lock-it function)	506300		
Locking device for a second tankbag (Tankring Lock-it already mounted)	506000		black
Locking device for a second tankbag (Tankring Basic already mounted)	516000		black



Item-no. 506300  
Anti-theft protection

### STREET LAPTOP BAG

Street Laptop bag	640700 00 01	15 Zoll	black
-------------------	--------------	---------	-------

Description	Item-no.	Info	Colours
<b>XTRAVEL SIDE BAG BASIC</b>			Incl. adapter plate



Xtravel Basic set	640630 00 01	33 l	grey
Xtravel Basic left	640631 00 01 L	33 l	grey
Xtravel Basic right	640631 00 01 R	33 l	grey

Description	Item-no.	Info	Colours
<b>XTRAVEL SIDE BAG C-BOW</b>			For use with the C-Bow holder only



Xtravel C-Bow set	640632 00 01	19 l	grey
-------------------	--------------	------	------

Description	Item-no.	Info	Colours
<b>XTRAVEL REAR BAG</b>			As strap set



Xtravel rear bag M	640634 00 01	23 - 30 l	grey
Xtravel rearbag XL	640635 00 01	50 l	grey



Description	Item-no.
<b>INSTALLATION KIT F. XTRAVEL BASIC</b>	

for H&B side carrier / Lock-it	500100
for H&B side carrier Cutout	500101
for SW-Motech side carrier EVO/PRO	500102
for Givi side carrier PL(R)xxxx / PL(R)xxxxCAM	500103
for Touratech side carrier	500104
for BMW original side carrier	500105



**ROTOPAX**  
Mounting on Xtravel  
Basic adapter plates  
possible!  
Mounting instruction:  
Item-no. 500106

Description	Item-no.	Info	Colours
<b>SPORT STAR</b>			



Small Sport Star for pillion seat	640002 00 00	18-28 l	black
Small Sport Star for rear racks	640012 00 00	15-25 l	black
Small Sport Star Rack f. BMW R1200GS/LC	640003 00 00	15-25 l	black

Description	Item-no.	Colours
<b>ACCESSORIES SPORT STAR</b>		

Rain cover for 640012	700420	black
Rain cover for 640002	700406	black

**NEW**



Description	Item-no.	Info	Colours
<b>DRYBRID</b>			

Drybrid Bag 30	640015 00 01	30 l	black/grey
Drybrid Bag 50	640016 00 01	50 l	black/grey

Description	Item-no.	Colours
<b>ACCESSORIES DRYBRID</b>		

Shoulder strap	710106	black
----------------	--------	-------

Description	Item-no.	Info	Colours
<b>CRASH BAR BAG SET V1</b>			For fastening to protection guards with straps



Universal Crash bar bag set	640100 00 01	3 l	black
-----------------------------	--------------	-----	-------

Article number see model price list or online shop.





Description	Item-no.	Info	Colours
<b>LEGACY SIDE BAGS C-BOW</b> <span style="float: right;">For use with C-Bow holder only.</span>			
Legacy courier bag M	6451976 00 08 M	9 l	green
Legacy courier bag L	6451976 00 08 L	13 l	green
Legacy courier bag set M/M	6451976 00 08 MM	9 l + 9 l	green
Legacy courier bag set M/L	6451976 00 08 ML	9 l + 13 l	green
Legacy courier bag set L/L	6451976 00 08 LL	13 l + 13 l	green
Legacy courier bag M	6451976 00 01 M	9 l	black
Legacy courier bag L	6451976 00 01 L	13 l	black
Legacy courier bag set M/M	6451976 00 01 MM	9 l + 9 l	black
Legacy courier bag set M/L	6451976 00 01 ML	9 l + 13 l	black
Legacy courier bag set L/L	6451976 00 01 LL	13 l + 13 l	black



Description	Item-no.	Info	Colours
<b>LEGACY TANK BAG M</b> <span style="float: right;">For use with Tank ring Lock-it only.</span>			
Legacy tank bag M Black	6451977 00 01	6 l	black



Description	Item-no.	Info	Colours
<b>LEGACY REAR BAG</b>			
Legacy rear bag	6451975 00 08 H	25 l	green
Legacy rear bag	6451975 00 01 H	25 l	black



Description	Item-no.	Info	Colours
<b>LEGACY TOOL BAG</b> <span style="float: right;">For mounting on the fork bars</span>			
Legacy tool bag	6451975 00 08 T	2,5 l	green
Legacy tool bag	6451975 00 01 T	2,5 l	black



Description	Item-no.	Info	Colours
<b>LEGACY TOOL BAG LEATHER</b> <span style="float: right;">For universal mounting</span>			
Legacy leather bag	6451975 00 08 W	2 l	brown



Description	Item-no.	Info	Colours
<b>LEGACY LEATHER SIDE BAGS</b> <span style="float: right;">For C-Bow holder or as leisure bag</span>			
Legacy briefcase C-Bow	6451976 00 08 A	8 l	sand brown
Legacy briefcase leisure bag	6451975 00 08 A	8 l	sand brown
Legacy briefcase C-Bow	6451976 00 01 A	8 l	black
Legacy briefcase leisure bag	6451975 00 01 A	8 l	black



Description	Item-no.	Info	Colours
<b>LEGACY REAR BAG LEATHER</b> <span style="float: right;">For mounting with straps on rear rack tube type</span>			
Legacy rear bag leather	6451975 00 19 R	4 l	brown
Legacy rear bag leather	6451975 00 18 R	4 l	rugged
Legacy rear bag leather	6451975 00 08 R	4 l	sand brown
Legacy rear bag leather	6451975 00 01 R	4 l	black

<b>ACCESSORIES LEGACY</b>			
Legacy leather belt	4201975 0001		black
Legacy leather belt	4201975 0008		brown
Legacy shoulder strap (Leather)	7401975 00 01	120 cm	brown
Legacy leather care	7101975 0001		
Legacy shoulder strap	7401975 00 02	120 cm	green
Legacy shoulder strap	7401975 00 03	120 cm	black
Rain cover courier bag M	700435		black
Rain cover courier bag L / briefcase	700436		black
Legacy rain cover rear bag	700437		black



# LIBERTY | NEVADA | IVORY LEATHER BAGS



Description	Item-no.	Info	Colours
<b>RUGGED C-BOW</b>		Leatherbags for C-Bow leather bag holder	
Rugged (set)	620355 00 08	21 l	brown
Rugged black (set)	620355 00 01	21 l	black
Rugged Smallbag	620356 00 08	19 l	brown
Rugged Smallbag	620356 00 01	19 l	black



Description	Item-no.	Info	Colours
<b>RUGGED CUTOUT</b>		Leatherbags - only suitable for Rugged Cutout holder	
Rugged Cutout (set)	620350 00 08	19 l	brown
Rugged Cutout black (set)	620350 00 01	19 l	black



Description	Item-no.	Info	Colours
<b>RUGGED CHEST LEATHER CASE</b>		Leather case for rear carrier	
Rugged Chest	620357 00 01	30 l	black
Rugged Chest f. Alurack	620359 00 01	30 l	black
Rugged Chest f. Easyrack	620360 00 01	30 l	black
Rugged Chest f. rear rack tube type*	620358 00 01	30 l	black

\*When ordering, specify the rear rack tube type item number.

## ACCESSORIES FOR RUGGED

Inner bag	700433		black
Inner bag Chest	700510		black
Rain cover set (2 Pcs.)	700434		black



Description	Item-no.	Info	Colours
<b>LIBERTY</b>		For leather bag holder tube type only.	
Liberty (set)	620980	21 l	black
Liberty Big (set)	620981	23 l	black

Spare parts  
see p. 143



Description	Item-no.	Info	Colours
<b>LIBERTY C-BOW</b>		For use with the C-Bow holder only	
Liberty (set)	620985	21 l	black
Liberty Big (set)	620986	23 l	black



Description	Item-no.	Info	Colours
<b>LIBERTY</b>		Handbag, Smallbag, Tool roll	
Liberty Handbag	620990	28 l	black
Liberty Smallbag incl. quick lock	620991	19 l	black
Liberty Handbag for Soloracks	620995	26 l	black
Liberty Tool roll	620900		black

## ACCESSORIES FOR LIBERTY

Inner bag f. Liberty / Liberty Big	700405		black
Rain cover Liberty	700406		black
Rain cover for Smallbag Liberty	700414		black
Rain cover for Handbag Liberty	700413		black
Carrying strap for Handbags	700401		black



Description	Item-no.	Info	Colours
<b>NEVADA</b>		For leather bag holder tube type only.	
Nevada (set)	620400	23 l	black



Description	Item-no.	Info	Colours
<b>NEVADA C-BOW</b>		For use with the C-Bow holder only	
Nevada (set)	620405	23 l	black

## ACCESSORIES FOR NEVADA

Rain cover	700406		black
------------	--------	--	-------



Description	Item-no.	Info	Colours
<b>IVORY</b>		For leather bag holder tube type only.	
Ivory (set)	620500	21 l	ivory/black
Ivory black (set)	620505	21 l	black

Description	Item-no.	Info	Colours
<b>IVORY C-BOW</b>		For use with the C-Bow holder only	
Ivory C-Bow (set)	620510	21 l	ivory/black
Ivory C-Bow black (set)	620515	21 l	black



Description	Item-no.	Info	Colours
<b>BUFFALO</b>			For leather bag holder tube type only.
Buffalo (set)	620200	21 l	black
Buffalo (set)	620200 00 08	21 l	sand brown
Buffalo Big (set)	620240	27 l	black

<b>BUFFALO C-BOW</b>			For use with the C-Bow holder only
Buffalo (set)	620230	21 l	black
Buffalo (set)	620230 00 08	21 l	sand brown
Buffalo Big (set)	620250	27 l	black



<b>BUFFALO CUSTOM</b>			For leather bag holder tube type only.
Buffalo Custom (set)	620205	21 l	black
Buffalo Big Custom (set)	620245	27 l	black

<b>BUFFALO CUSTOM C-BOW</b>			For use with the C-Bow holder only
Buffalo Custom (set)	620235	21 l	black
Buffalo Big Custom (set)	620255	27 l	black



<b>BUFFALO / BUFFALO CUSTOM</b>			Handbag, Smallbag, Tool roll
Buffalo Handbag	620210	33 l	black
Buffalo Smallbag	620225	19 l	black
Buffalo Tool roll	620800		black
Buffalo Custom Handbag	620215	33 l	black
Buffalo Custom Smallbag	620220	19 l	black
Buffalo Custom Tool roll	620850		black

<b>ACCESSORIES FOR BUFFALO / IVORY</b>			
Rain cover for leather bags	700407		black
Rain cover for Handbags	700412		black
Rain cover for Smallbags	700414		black
Inner bag for leather bags	700408		black
Rain cover for leather bags Big	700430		black
Inner bag for leather bags Big	700431		black



<b>REAR RACK ENLARGEMENT FOR HANDBAGS</b>			
polished and anodized	800000 00 09		



## SPECIAL NOTES For leather bag holder tube type only.

### Versions for self-mounting

**Leather bags for saddle bag holder - fixed mounting for self-assembly**  
Self-assembly version with fastening set for fixed mounting on the saddlebag holder (saddlebags cannot be removed). Holes must be drilled in the back of the saddlebag.

Fixed mounting fastening Self-assembly	700429	piece
--	--------	-------

**Leather bag for leather bag holder - optional with quick lock for home installation**  
Another option when using a bag holder is our quick lock at additional charge for home assembly. This allows the leather bag to be removed from the bag holder at any time. Moreover, the lock works from inside the bag, securing the bag from theft. Home installation is very difficult.

quick lock home installation	700403	piece
------------------------------	--------	-------

### Versions fixed and ready assembled

**Leather bag for leather bag holder - optional with quick lock installed at the factory**  
Another option when using a bag holder is our factory-installed quick lock. It allows the leather bag to be removed from the bag holder at any time. The lock also locks inside the bag to prevent theft. The leather bag and bag holder have to be ordered together and installed in pairs.

quick lock incl. factory installation	700402	piece
---------------------------------------	--------	-------

**NOTE:** For all versions, the leather bag matches only the bag holder it is attached to. Once the quick locks are installed, a leather bag can no longer be returned.

**C-Bow leather bag for C-Bow leather bag holder**  
We recommend the leather bag's C-Bow version (if a C-Bow holder is offered for your motorcycle). This requires no home installation and switching the model to a different motorcycle with C-Bow is no problem.



Description                      Item-no.                      Info                      Colours

## CANISTER CUTOOUT SET

Set contents: cutout metal canister and special carrier. One-sided, left.

Canister Set		4 l	black
--------------	--	-----	-------

### For the following models available:

Indian Motorcycle Scout Bobber (2017-)	Harley-Davidson Sportster Seventy-Two
Moto Guzzi V9 Roamer	Harley-Davidson XR 1200
Moto Guzzi V9 Bobber	Harley-Davidson Dyna Street Bob
Harley-Davidson Sportster Super Low	Harley-Davidson Dyna Low Rider
Harley-Davidson Sportster 833 Low	Harley-Davidson Dyna Wide Glide
Harley-Davidson Sportster 833 Roadster	Harley-Davidson Dyna Fat Bob
Harley-Davidson Sportster 833 Iron	Harley-Davidson Dyna Super Glide
Harley-Davidson Sportster 833 Custom	Yamaha XV 950 / R ab 2013
Harley-Davidson Sportster 1200 Custom	
Harley-Davidson Sportster Forty-Eight	

Item-no. see modellist

## UNIVERSAL CANISTER C-BOW

Set contents: metal canister and special carrier for C-Bow holder.

Canister set C-Bow	740007	5 l	black
--------------------	--------	-----	-------

Spare parts for case & top case see relevant product pages in this catalogue!

Description                      Item-no.                      Info                      Colours

## SPARE PARTS ALURACK

Bow Alurack	700006882		black
Bow Alurack	700006886		silver
Cover Alurack	700006883		black

## SPARE PARTS EASYRACK

Cover left	700008647		black
Cover right	700008648		black

## SPARE PARTS CARRIER / GUARD

Please state motorbike model or Hepco&Becker item number when requesting a quote.  
Customer service: [shop@hepco-becker.de](mailto:shop@hepco-becker.de)

## SPARE PARTS PROTECTIONPADS

Protectionpad Set (2 Pcs.)	5070050	185	black
----------------------------	---------	-----	-------



Example: YAMAHA XV 950 / R



Example: MOTO GUZZI V9 Roamer

Description      Item-no.      Info      Colours



## LOCKABLE LOCK-IT SCREW

Anti-Theft device. Replace one of the Lock-it screws on each side of the bike with this lockable screw.

Lock-it screw	151050		black
---------------	--------	--	-------



## LOCK-IT SCREW

Lock-it screw, filisterhead screw	151070		
-----------------------------------	--------	--	--



## LOCKING CYLINDER / KEY

\*Enter the desired key number.

Locking cylinder with key	710109-xxx*		
---------------------------	-------------	--	--

Key	710110-xxx*		
-----	-------------	--	--

Locking cylinder with key for universal Top case	710116-xxx*		
--	-------------	--	--



## ADAPTER SET FOR C-BOW HOLDER / ROTOPAX

Distance holder for rear bags. For mounting of Rotopax canisters.

Adapter set C-Bow holder / Rotopax	710634 00 01		black
------------------------------------	--------------	--	-------



## MINI FIRST AID KIT

Mini first aid kit	7101975 0004		
--------------------	--------------	--	--



## ADAPTER FOR SIDE CARRIER

For mounting on side carriers to hook in the case lock.

Adapter for plastic cases and mix cases. Xplorer, Xceed, Junior, Journey, Gobi	710135		black
--	--------	--	-------

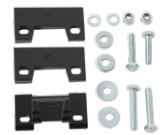

Adapter for aluminum cases: Alu Exclusiv und Alu Standard	710081		black
---	--------	--	-------



## C-BOW HOLDER BLACK/CHROME

Spare part for C-Bow holder

C-Bow holder spare part	700007063		black
-------------------------	-----------	--	-------

C-Bow holder spare part	700007062		chrome
-------------------------	-----------	--	--------



## C-BOW COUNTER PART

Spare part for Hepco&Becker bags. Incl. cylinder, key and screws.

C-Bow counter part	700427		black
--------------------	--------	--	-------

Locking cylinder & key for C-Bow counter part (please indicate key number)	710143-xxx		
--	------------	--	--



## BACK REST SISSYBAR / SOLORACK

Back rest <b>small</b> for Sissybar	700300		black
-------------------------------------	--------	--	-------

Back rest <b>medium</b> for Sissybar	700309		black
--------------------------------------	--------	--	-------

Back rest <b>medium</b> for Sissybar	700310		brown
--------------------------------------	--------	--	-------

Back rest <b>big</b> for Sissybar	700301		black
-----------------------------------	--------	--	-------



## HEAT SHIELD FOR SIDE CASE

Heat shield small	42250000 00 22		Stainless steel
-------------------	----------------	--	-----------------



## UNIVERSAL TOOL BAG

Tool bag 15	640013 00 01		black
-------------	--------------	--	-------

Tool bag 5	640014 00 01		black
------------	--------------	--	-------



## UNIVERSAL TOOL BOX

Incl. 4 cable ties for self mounting.

Universal tool box	741000 00 01		black
--------------------	--------------	--	-------



## ANTI-VIBRATION MAT

approx. 250x200x1,6mm / 100g

Anti-vibration mat	710215		
--------------------	--------	--	--



## SLIDEPAD SET

For engine and tank protection bars with 22 or 25 mm tube diameter.

Slidepad	5070051 00 01		black
----------	---------------	--	-------



Universal Alurack

## UNIVERSAL RACKS

Specific aluminum base plate for the assembly of Hepco&Becker Top cases. Incl. fixing material for mounting on existing rear racks.

Universal Alurack	610049 00 01		black
-------------------	--------------	--	-------

Universal Alurack	610049 00 09		silver
-------------------	--------------	--	--------



Universal Easyrack

Universal Easyrack (not suitable for Orbit TC54 and Alu Standard)	610100 00 01		black
---	--------------	--	-------

Universal rack only for Orbit TC 54	610149 00 01		black
-------------------------------------	--------------	--	-------

# UNIVERSAL ACCESSORIES

Description	Item-no.	Info	Colours
<b>UNIVERSAL ENLARGEMENT BLACK/SILVER</b>			
Incl. mounting kit for existing rear racks.			
Universal enlargement	610053 00 01		black
Universal enlargement	610053 00 09		silver
Universal enlargement small	610052 00 01		black
Universal enlargement small	610052 00 09		silver



<b>TOP CASE PANEL TUBE TYPE</b>			
For mounting Hepco&Becker Top cases on existing rear racks. Incl. mounting kit for existing rear racks.			
Top case panel	610050 00 01		black



<b>COMBINATION LOCK</b>			Prevents unauthorized opening.
Combination lock	7105590		black
Combination lock with 50 cm Wire	7105591		black



<b>UNIVERSAL HOLDER FOR ACCESSORIES</b>			
Fastened to the case exterior. Let's you carry your accessories along with you, fastened to the case with straps (not included)			
Universal holder	740003		black

**NOTE:** This requires holes to be drilled in the case/top case



<b>MULTIFUNCTIONAL HEADWEAR</b>			
Multifunctional headwear	7101975 0003		black



<b>PAINT REPAIR KIT</b>			
Paint repair kit Silver	710635 00 09		silver
Paint repair kit Matte Black	710635 00 01-1		matte black
Paint repair kit Glossy Black	710635 00 01-3		glossy black
Paint repair kit Anthracite	710635 00 05-2		anthracite

**NEW**



<b>NOVA LED AUXILIARY HEADLIGHTS</b>			
Universal mounting thanks to adjustable clamps. Can be mounted standing or hanhing. Two switching levels at 2,500lm - 4,350K / - 5,500K. Complete set incl. clamps, tools, cable set.			
NOVA LED auxiliary headlights (set)	731107		black



Description	Item-no.	Info	Colours
<b>C-BOW HOLDER SHIFTING / ENLARGEMENT</b>			
Improved comfort. Shifts the C-Bow holder 50mm backwards/forwards. Improves the seating comfort of the pillion seat enormously when side pockets are fitted. Vertical: Installation 3cm upwards/downwards.			
C-Bow shifting horizontal	710630 00 01		black
C-Bow shifting horizontal	710630 00 02		chrome
C-Bow shifting vertical	720630 00 01		black
C-Bow shifting vertical	720630 00 02		chrome
C-Bow enlargement 10mm	710631 00 01		black
C-Bow enlargement 20mm	710632 00 01		black
C-Bow enlargement 40mm	710633 00 01		black

**Note:** Not suitable for all models - may collide with turn signals or license plate holder. Please check your bike.



<b>CENTER STAND MOUNTING TOOL</b>			
For easy mounting of the center stand spring.			
Center stand mouting tool	710134		



<b>REFLECTION STRIPES</b>			
Self-adhesive 1m lenght. Width 55mm. Cutable for your own needs.			
Reflection stripes	710234 00 03		white
Reflection stripes	710234 00 04		red



<b>H&amp;B STRAP SET</b>			
Each 25mm wide, 1,8m long for save lashing the soft luggage.			
H&B Strap set (2 Pcs.)	740012		black



<b>BOTTLE HOLDER</b>			
Bottle holder (Bracket set for bottles)	740004		black
Aluminum bottle with H&B emblem	740015	0,6 l	



<b>2 LITRES WATER CANISTER</b>			
2 L water canister with universal holder	740005		
2 L water canister with Ø 29mm	740006		black

Item-no.	Description	Info's
<b>AREA 51 (1998-2003)</b>		
650828 00 01	Top case carrier	13
<b>Gulliver 50 (1996-1999)</b>		
650824 00 09	Top case carrier	13
<b>Rally 50 (1995-1998)</b>		
650823 00 01	Top case carrier	13
<b>Sonic / Sonic LC (1998-2003)</b>		
650827 01 01	Rear rack	13
<b>SR 50 (1994-2000)</b>		
650820 00 01	Top case carrier	13
<b>SR 50. WWW (1997-2004)</b>		
650826 00 01	Top case carrier	13
<b>SR 50 R / Factory (2005-)</b>		
650839 01 01	Rear rack	13
<b>Habana 50-125 Custom (1999-2001) / Mojito (2004-)</b>		
501833 00 02	Engine guard	
650833 01 02	Rear rack	13
<b>Leonardo 125 / 150 (1996-1998)</b>		
650825 01 09	Rear rack	13
<b>Leonardo 125 (1999-2001)</b>		
650832 01 01	Rear rack	13
<b>RS 125 (2006-)</b>		
506001-6	Tank ring Lock-it	
516001-6	Tank ring Basic	
<b>SX 125 (2008-)</b>		
506001-6	Tank ring Lock-it	
516001-6	Tank ring Basic	
<b>Tuono 125 (2016-)</b>		
5067576 00 01	Tank ring Lock-it	900
5167576 00 01	Tank ring Basic	700

Item-no.	Description	Info's
<b>SR GT 125 / 200 / Sport (2022-)</b>		
6507648 01 01-089 bl	Set with Journey TC 40	
6507648 01 01-089 si	Set with Journey TC 40	
6507648 01 01-206	Set with Journey TC 30	
6527648 01 01	Alurack	
6617648 01 01	Easyrack	
6607648 01 01	Minirack	
<b>Leonardo 150 (1999-2000)</b>		
650832 01 01	Rear rack	13
<b>Leonardo 250 (1999-2001)</b>		
650829 01 09	Rear rack	13
<b>SVX 450/550 (2006-)</b>		
506001-6	Tank ring Lock-it	
516001-6	Tank ring Basic	
<b>Atlantic 500 (2002-2005)</b>		
650781 01 09	Rear rack	
<b>Tuareg 600 Wind (1988-1993)</b>		
650716 00 01	Side carrier	0
<b>Pegaso 650 (1992-1995)</b>		
650726 00 01	Side carrier	
650726 01 01	Rear rack	9
<b>Pegaso 650 (1996-)</b>		
650748 00 01	Side carrier	
650748 01 01	Rear rack	9
502701 00 01	Engine guard	
<b>Pegaso 650 / Garda (1997-2004)</b>		
650750 00 01	Side carrier	
650750 01 01	Rear rack	9
502702 00 01	Engine guard	

Item-no.	Description	Info's
<b>Pegaso 650 Strada (2005-2009)</b>		
650791 00 01	Side carrier Lock-it	
650791 01 01	Rear rack	
502791 00 01	Engine guard	
505791 00 01	Center stand	
506791 00 01	Tank ring Lock-it	900
516791 00 01	Tank ring Basic	700
<b>Pegaso 650 Trail (2006-2009)</b>		
650791 00 01	Side carrier Lock-it	
650791 01 01	Rear rack	
502791 00 01	Engine guard	
505792 00 01	Center stand	
506791 00 01	Tank ring Lock-it	
516791 00 01	Tank ring Basic	
<b>RS / Tuono 660 (2020-)</b>		
5067597 00 01	Tank ring Lock-it	900
5167597 00 01	Tank ring Basic	700
6307597 00 01	C-Bow holder	89
6707597 00 01	Sportrack	52
<b>Tuareg 660 (2022-)</b>		
6517599 00 01-00-40	Xplorer Cutout Set	
6517599 00 01-01-40	Xplorer Cutout Set Black	
6527599 01 01	Alurack	
6617599 01 01	Easyrack	
8007599 00 01	Rear rack enlargement	
6607599 01 01	Minirack	
5027599 00 01	Tank guard	
5027599 00 09	Tank guard	
42127599 00 01	Handle guard	
7007599 00 01	Headlight grilles	112
731107	LED auxiliary headlights Nova	133
5057599 00 01	Center stand	

Item-no.	Description	Info's
<b>SL 750 Shiver (2007-2009)</b>		
650752 01 01	Alurack	
661752 01 01	Easyrack	
630752 00 01	C-Bow holder	
506752 00 01	Tank ring Lock-it	900
516752 00 01	Tank ring Basic	700
<b>SL 750 Shiver GT (2009-2016)</b>		
650752 01 01	Alurack	
661752 01 01	Easyrack	
630752 00 01	C-Bow holder	
<b>SL 750 Shiver (2010-2016)</b>		
6507508 01 01	Alurack	
6617508 01 01	Easyrack	
6307508 00 01	C-Bow holder	
<b>NA 850 Mana / GT (2007-)</b>		
650776 00 01	Side carrier Lock-it	
650776 01 01	Alurack	77
661776 01 01	Easyrack	77
630776 00 01	C-Bow holder	96
700007437	Pillion handle (from 630776)	96
<b>Shiver 900 (2017-)</b>		
6307549 00 01	C-Bow holder	
5067549 00 01	Tank ring Lock-it	900
5167549 00 01	Tank ring Basic	700
<b>Caponord ETV 1000 (2001-2007)</b>		
650777 00 01	Side carrier	
650777 01 01	Rear rack	9, 56
502703 00 01	Engine guard	
506777 00 01	Tank ring Lock-it	900
516777 00 01	Tank ring Basic	700
<b>SL 1000 Falco (2000-2003)</b>		
650767 01 01	Rear rack	
506767 00 01	Tank ring Lock-it	900
516767 00 01	Tank ring Basic	700

## NOTICE Tank rings APRILIA

Our Tank ring Lock-it 506001-6 / Basic 516001-6 fits all APRILIA Models with 6 Hole mounting.

506001-6 Tank ring Lock-it 6-hole

516001-6 Tank ring Basic 6-hole



**ATTENTION: You can find the new 2024 models online at [www.hepco-becker.de](http://www.hepco-becker.de)**



# APRILIA

Item-no.	Description	Info's
<b>RST 1000 Futura (2001-2003)</b>		
650771 01 01	Rear rack	
506771 00 01	Tank ring Lock-it	900
516771 00 01	Tank ring Basic	700
<b>RSV Mille / Tuono (1998-2008)</b>		
650780 01 01	Rear rack	
506780 00 01	Tank ring Lock-it	900
516780 00 01	Tank ring Basic	700
<b>Tuono V 4 R (2011-2014)</b>		
6307501 00 01	C-Bow holder	
6507501 01 01	Alurack	
6617501 01 01	Easyrack	
6707501 00 01	Sportrack	52
<b>Tuono 1000 R / Factory (2009-2011)</b>		
630780 00 01	C-Bow holder	
670780 00 01	Sportrack	52
<b>Tuono V4 1100 Factory (2011-2020)</b>		
670701 00 01	Sportrack	52
<b>Tuono V4 1100 RR (2015-2020)</b>		
6707501 00 01	Sportrack	52
6307501 00 01	C-Bow holder	
6507501 01 01	Alurack	
6617501 01 01	Easyrack	
<b>RSV 4 (2011-2020) / RSV 4 RR / RF (2015-2020)</b>		
670701 00 01	Sportrack	52
<b>Tuono V4 Factory / RSV 4 / RSV 4 Factory (2021-)</b>		
6707626 00 01	Sportrack	52,92, 169
6307626 00 01	C-Bow holder	4:1
42117626 00 91	Side stand enlargement	232
<b>Tuono V4 (2021-)</b>		
6307625 00 01	C-Bow holder	4:1
6707625 00 01	Sportrack	52,92, 169
42117625 00 91	Side stand enlargement	232

Item-no.	Description	Info's
<b>Caponord 1200 / Rally (2013-2016)</b>		
6507514 00 01	Side carrier Lock-it	
6507514 01 01	Alurack	9, 56
6617514 01 01	Easyrack	9, 56
6307514 00 01	C-Bow holder	
5017514 00 01	Engine guard	
8007514 00 01	Rear rack enlargement	
731107	LED auxiliary headlights Nova	133
4207514-01	Handle guard	

<b>NOTICE Tank rings APRILIA</b>		
Our Tank ring Lock-it 506001-6 / Basic 516001-6 fits all APRILIA Models with 6 Hole mounting.		
506001-6	Tank ring Lock-it 6-hole	
516001-6	Tank ring Basic 6-hole	

**ATTENTION: You can find the new 2024 models online at [www.hepco-becker.de](http://www.hepco-becker.de)**



Info reference see p. 271

The last digit of the item-no. refers to the colours: 01= black 02= chrome 03= white 04= red 05= anthracite 06= orange 08= yellow 09= silver 10= blue metallic 12= Alu brushed 22= Stainless steel 91= silver/black

Item-no.	Description	Info
<b>G 310 R (2016-)</b>		
6526501 01 01	Alurack	
6616501 01 01	Easyrack	
6606501 01 01	Minirack	
6306501 00 01	C-Bow Holder	
5016501 00 01	Engine guard	
5016501 01 01	Engine guard incl. Protectionpad	
5036501 00 01	Front Guard	
5046501 00 01	Rear Guard	
42236501 00 01	Rear guard additional bow	29
5066501 00 01	Tank ring Lock-it	900
5166501 00 01	Tank ring Basic	700
8106501 00 12	Skid plate	
<b>G 310 GS (2017-)</b>		
6536507 00 01	Side carrier (2017-2019)	
6506507 00 01	Side carrier (2020-)	0
6306507 00 01	C-Bow Holder	
6556507 01 01	Alurack f. Original rack	
6626507 01 01	Easyrack f. Original rack	
5016507 00 01	Engine guard	
5016507 01 01	Engine guard incl. Protectionpad	
5026507 00 01	Tank guard	65
6416507 00 01	Crash bar bag set V1	
5066507 00 01	Tank ring Lock-it	900
5166507 00 01	Tank ring Basic	700
7006507 00 01	Headlight grilles	112
42116507 00 91	Side stand enlargement	
5056507 00 01	Center stand	
8106507 00 12	Skid plate	
<b>C 400 GT (2019-)</b>		
6526516 01 01	Alurack	
6616516 01 01	Easyrack	
6606516 01 01	Minirack	

Item-no.	Description	Info
<b>R 45 (1978-1985)</b>		
650604 00 01	Complete carrier	16
650604 00 02	Complete carrier	16
<b>R 60/6 (1973-1986)</b>		
650613 00 02	Complete carrier	
<b>C 600 Sport (2012-2015) / C 650 Sport (2016-)</b>		
650662 01 01	Alurack	
661662 01 01	Easyrack	
<b>C 650 GT (2012-)</b>		
650663 01 01	Alurack	
661663 01 01	Easyrack	
<b>R 65 (1978-1985)</b>		
650604 00 01	Complete carrier	16
650604 00 02	Complete carrier	16
<b>R 65 (1986-1993)</b>		
650605 00 02	Complete carrier	17
650605 01 01	Rear rack	22
650605 01 02	Rear rack	22
<b>R 65 G/S (1987-1992)</b>		
650600 00 01	Complete carrier	0,5: A,B, C,D,E,F
650611 00 01	Complete carrier	49
650611 01 01	Rear rack	88
<b>F 650 (1993-1996)</b>		
650618 00 01	Side carrier	0
650618 01 01	Rear rack	9
502900 00 01	Engine guard	
506900 00 01	Tank ring Lock-it	901
516900 00 01	Tank ring Basic	701
<b>F 650 (1997-2000)</b>		
650618 00 01	Side carrier	0
650618 01 01	Rear rack	9
502906 00 01	Engine guard	

Item-no.	Description	Info
<b>F 650 ST (1997-2000)</b>		
650618 00 01	Side carrier	0
650618 01 01	Rear rack	9
502906 00 01	Engine guard	
506906 00 01	Tank ring Lock-it	900,4: L1, L2, M1
516906 00 01	Tank ring Basic	700,4: L1, L2, M1
<b>F 650 GS Dakar (2000-2003)</b>		
650628 00 09	Side carrier	2:A1,B1, C1
650628 01 09	Rear rack	9
630660 00 01	C-Bow Holder	
502912 00 09	Engine guard	
505628 00 01	Center stand	
<b>F 650 GS (2001-2003)</b>		
650628 00 09	Side carrier	2:A1,B1, C1
650628 01 09	Rear rack	9
630660 00 01	C-Bow Holder	
502912 00 09	Engine guard	
505629 00 01	Center stand	8
<b>F 650 GS Dakar (2004-2007)</b>		
650638 00 09	Side carrier	5,234
650638 01 09	Rear rack	9
630660 00 01	C-Bow Holder	
800638 00 09	Rear rack enlargement	
502912 00 09	Engine guard	
505628 00 01	Center stand	
<b>F 650 GS / G 650 GS (2004-2007)</b>		
650638 00 09	Side carrier	2:A1,B1, C1,234
650638 01 09	Rear rack	9
630660 00 01	C-Bow Holder	
800638 00 09	Rear rack enlargement	
502912 00 09	Engine guard	
505629 00 01	Center stand	8
700638 00 01	Headlight grilles	112

Item-no.	Description	Info
<b>G 650 GS (2009-2016)</b>		
650628 00 09	Side carrier	2:A1,B1, C1
650628 01 09	Rear rack	9
630660 00 01	C-Bow Holder	
502912 00 09	Engine guard	
505629 00 01	Center stand	8
<b>F 650 CS (2002-2005)</b>		
650633 00 09	Side carrier	
650633 01 09	Rear rack	9
502914 00 09	Engine guard	
505633 00 01	Center stand	

**NOTICE Tank rings BMW**

Our tank ring Lock-it 506003-6 / Basic 516003-6 fits all BMW models with 6 hole mounting.

506003-6	Tank ring Lock-it 6 hole
516003-6	Tank ring Basic 6 hole

Our tank ring Lock-it 506002-5 / Basic 516002-5 fits all BMW models with 5 hole mounting.

506002-5	Tank ring Lock-it 5 hole
516002-5	Tank ring Basic 5 hole

Our tank ring Lock-it 506005-0 / Basic 516005-0 fits all BMW models with inner mounting.

506005-0	Tank ring Lock-it inner mounting
516005-0	Tank ring Basic inner mounting

**ATTENTION: You can find the new 2024 models online at [www.hepco-becker.de](http://www.hepco-becker.de)**



Item-no.	Description	Info	Item-no.	Description	Info	Item-no.	Description	Info	Item-no.	Description	Info	
<b>F 650 GS Twin (2008-2011)</b>			<b>G 650 GS (2011-2016)</b>			<b>G 650 X Challenge (2007-2010) / G 650 X Moto</b>			<b>F 700 GS (2012-2017)</b>			
650664 00 01	Side carrier	0,95	650660 00 01	Side carrier Lock-it	234	650650 00 01	Side carrier Lock-it	0	650664 00 01	Side carrier	0,95	
651652 00 22	Cutout Carrier	4:C3,C4	650660 01 09	Rear rack	9	650650 01 01	Rear rack		651652 00 22	Cutout Carrier	4:C3,C4	
651652 00 22-00-40	Xplorer Cutout Set		630660 00 01	C-Bow Holder		502934 00 01	Engine guard		651652 00 22-00-40	Xplorer Cutout Set		
651652 00 22-01-40	Xplorer Cutout Set black		506667 00 01	Tank ring Lock-it	4: M1, L1, L2, L3	505651 00 01	Center stand		651652 00 22-01-40	Xplorer Cutout Set black		
650652 01 01	Alurack		516667 00 01	Tank ring Basic	4: M1, L1, L2, L3				650652 01 01	Alurack		
661652 01 01	Easyrack		502660 00 01	Engine guard					661652 01 01	Easyrack		
650664 01 01	Rear rack		800660 00 09	Rear rack enlargement					650664 01 01	Rear rack		
630652 00 01	C-Bow Holder		810660 00 12	Skid plate					630652 00 01	C-Bow Holder		
502935 00 01	Engine guard		700660 00 01	Headlight grilles	112				502935 00 01	Engine guard		
502935 00 04	Engine guard		<b>G 650 GS Sertao (2012-2016)</b>						502935 00 04	Engine guard		
502938 00 01	Tank guard	65	650660 00 01	Side carrier Lock-it	234				502938 00 01	Tank guard	65	
810652 00 12	Skid plate		650660 01 09	Rear rack	9				502938 00 01	Tank guard	65	
800652 00 09	Rear rack enlargement		630660 00 01	C-Bow Holder					731107	LED auxiliary headlights Nova	133	
731107	LED auxiliary headlights Nova	133	502660 00 01	Engine guard					505652 00 01	Center stand		
700652 00 01	Headlight grilles	112	505628 00 01	Center stand					810652 00 12	Skid plate		
505652 00 01	Center stand		800660 00 09	Rear rack enlargement					800652 00 09	Rear rack enlargement		
503652 00 01	Front Guard		810660 00 12	Skid plate					700652 00 01	Headlight grilles	112	
504652 00 01	Rear Guard		700660 00 01	Headlight grilles	112				503652 00 01	Front Guard		
420653-01	Handle guard	83	<b>G 650 X Country (2007) / G 650 X Moto (2007-2010)</b>						504652 00 01	Rear Guard		
506667 00 01	Tank ring Lock-it	4: M1, L1, L2, L3	650650 00 01	Side carrier Lock-it	0	<b>NOTICE Tank rings BMW</b>						
516667 00 01	Tank ring Basic	4: M1, L1, L2, L3	650650 01 01	Rear rack		Our tank ring Lock-it 506003-6 / Basic 516003-6 fits all BMW models with 6 hole mounting.						
4211652 00 91	Side stand enlargement		502934 00 01	Engine guard		506003-6	Tank ring Lock-it 6 hole					
741100 00 01	Tool box		505650 00 01	Center stand		516003-6	Tank ring Basic 6 hole					
			700656 00 01	Headlight grilles	112	Our tank ring Lock-it 506002-5 / Basic 516002-5 fits all BMW models with 5 hole mounting.						
			<b>G 650 X Country (2008-2010)</b>									
			650656 00 01	Side carrier Lock-it	0,70	506002-5	Tank ring Lock-it 5 hole					
			650656 01 01	Rear rack		516002-5	Tank ring Basic 5 hole					
			502934 00 01	Engine guard		Our tank ring Lock-it 506005-0 / Basic 516005-0 fits all BMW models with inner mounting.						
			505650 00 01	Center stand		506005-0	Tank ring Lock-it inner mounting					
			700656 00 01	Headlight grilles	112	516005-0	Tank ring Basic inner mounting					

**ATTENTION: You can find the new 2024 models online at [www.hepco-becker.de](http://www.hepco-becker.de)**



Info reference see p. 271

The last digit of the item-no. refers to the colours: 01= black 02= chrome 03= white 04= red 05= anthracite 06= orange 08= yellow 09= silver 10= blue metallic 12= Alu brushed 22= Stainless steel 91= silver/black

Item-no.	Description	Info
<b>F 750 GS (2018-)</b>		
6556512 01 01	Alurack	
6626512 01 01	Easyrack	
6526512 01 01	Alurack	157
6616512 01 01	Easyrack	157
6606512 01 01	Minirack	
6506512 00 01	Side carrier Lock-it	0
6516512 00 22	Cutout Carrier	4:C3,C4
6516512 00 22-00-40	Xplorer Cutout Set	
6516512 00 22-01-40	Xplorer Cutout Set black	
5016512 00 22	Engine guard	
5026512 00 22	Tank guard	
5016512 00 01	Engine guard	
5026512 00 01	Tank guard	
640100 00 01	Crash bar bag set V1	
7006512 00 01	Headlight grilles	112
42126512 00 01	Handle guard	
5066512 00 01	Tank ring Lock-it	902
5166512 00 01	Tank ring Basic	702
42116512 00 91	Side stand enlargement	
8106512 00 12	Skid plate	
6306512 00 01	C-Bow Holder	181
731107	LED auxiliary headlights Nova	133
5036512 00 01	Front Guard	158
5046512 00 01	Rear Guard	
8006512 00 01	Rear rack enlargement	
8016512 00 01	Rear rack enlargement	157
741100 00 01	Tool box	
<b>R 75/6 (1973-1976)</b>		
650613 00 02	Complete carrier	
<b>K 75 C (1985-1989)</b>		
650603 00 01	Complete carrier	
650603 01 01	Rear rack	22

Item-no.	Description	Info
<b>K 75 S (1985-1989)</b>		
650603 00 01	Complete carrier	
650603 01 01	Rear rack	22
<b>K 75 RT (1990-1996)</b>		
650615 00 01	Complete carrier	
650615 01 01	Rear rack	
<b>K 75 S (1990-1996)</b>		
650615 00 01	Complete carrier	
650615 01 01	Rear rack	

<b>NOTICE Tank rings BMW</b>		
Our tank ring Lock-it 506003-6 / Basic 516003-6 fits all BMW models with 6 hole mounting.		
506003-6	Tank ring Lock-it 6 hole	
516003-6	Tank ring Basic 6 hole	
Our tank ring Lock-it 506002-5 / Basic 516002-5 fits all BMW models with 5 hole mounting.		
506002-5	Tank ring Lock-it 5 hole	
516002-5	Tank ring Basic 5 hole	
Our tank ring Lock-it 506005-0 / Basic 516005-0 fits all BMW models with inner mounting.		
506005-0	Tank ring Lock-it inner mounting	
516005-0	Tank ring Basic inner mounting	

Item-no.	Description	Info
<b>F 800 GS (2008-2018)</b>		
650664 00 01	Side carrier	0,95
651653 00 22	Cutout Carrier	4:C3,C4
651653 00 22-00-40	Xplorer Cutout Set	
651653 00 22-01-40	Xplorer Cutout Set black	
650653 01 01	Alurack	
661653 01 01	Easyrack	
650664 01 01	Rear rack	
630652 00 01	C-Bow Holder	
502936 00 01	Engine guard	
502936 00 04	Engine guard	
502938 00 01	Tank guard (-2016)	65
502938 00 04	Tank guard (-2016)	65
5026509 00 01	Tank guard (2017-)	65
5026509 00 04	Tank guard (2017-)	65
640100 00 01	Crash bar bag set V1	
505653 00 01	Center stand	
810653 00 12	Skid plate	
700653 00 01	Headlight grilles	112
800652 00 09	Rear rack enlargement	
731107	LED auxiliary headlights Nova	133
503652 00 01	Front Guard	
504652 00 01	Rear Guard	
420653-01	Handle guard	83
506667 00 01	Tank ring Lock-it	4: M1, L1,L2,L3
516667 00 01	Tank ring Basic	4: M1, L1,L2,L3
4211653 00 91	Side stand enlargement	
741100 00 01	Tool box	

Item-no.	Description	Info
<b>F 800 GS Adventure (2013-2018)</b>		
650667 01 01	Alurack	
661667 01 01	Easyrack	
660667 01 01	Minirack	10,72
800667 00 01	Rear rack enlargement	
502606 00 01	Tank guard	94
502606 00 22	Tank guard	94
640100 00 01	Crash bar bag set V1	
731107	LED auxiliary headlights Nova	133
810667 00 09	Skid plate	
505667 00 01	Center stand	
700667 00 01	Headlight grilles	112
420667-01	Handle guard	83
506667 00 01	Tank ring Lock-it	4: M1, L1,L2,L3
516667 00 01	Tank ring Basic	4: M1, L1,L2,L3
4211667 00 91	Side stand enlargement	
<b>F 800 GT (2013-2019)</b>		
650666 01 01	Alurack	68
661666 01 01	Easyrack	68
630666 00 01	C-Bow Holder	
506666 00 01	Tank ring Lock-it	
516666 00 01	Tank ring Basic	
<b>F 800 R (2009-2014)</b>		
650657 01 01	Alurack	68
661657 01 01	Easyrack	68
630657 00 01	C-Bow Holder	
506666 00 01	Tank ring Lock-it	
516666 00 01	Tank ring Basic	
502937 00 01	Engine guard	
505657 00 01	Center stand	
700657 00 01	Headlight grilles	112

**ATTENTION: You can find the new 2024 models online at [www.hepco-becker.de](http://www.hepco-becker.de)**





Item-no.	Description	Info
<b>F 800 R (2015-2019)</b>		
650674 01 01	Alurack	68
661674 01 01	Easyrack	68
630674 00 01	C-Bow Holder	
501674 00 01	Engine guard	
505674 00 01	Center stand	
506666 00 01	Tank ring Lock-it	
516666 00 01	Tank ring Basic	
502674 00 01	Engine guard	155
503674 00 01	Front Guard	
504674 00 01	Rear Guard	
<b>F 800 S (2006-2011)</b>		
650642 00 01	Side carrier Lock-it	99 3:C,D
650642 01 01	Rear rack	
630642 00 01	C-Bow Holder	
502920 00 01	Engine guard	
502920 00 09	Engine guard	
505647 00 01	Center stand	
506666 00 01	Tank ring Lock-it	
516666 00 01	Tank ring Basic	
<b>F 800 ST (2006-2012)</b>		
650647 00 01	Side carrier Lock-it	99 3:C,D
650647 01 09	Rear rack	68
630642 00 01	C-Bow Holder	
505647 00 01	Center stand	
506666 00 01	Tank ring Lock-it	
516666 00 01	Tank ring Basic	
<b>R 80 G/S (1980-1987)</b>		
650600 00 01	Complete carrier	0,5: A,B, C,D,E,F
650600 01 01	Rear rack	88
<b>R 80 GS (1987-1996)</b>		
650609 00 01	Side carrier	20, 49
650609 01 01	Rear rack	
<b>R 80 G/S Paris-Dakar (-1988)</b>		
650606 00 01	Side carrier	0,20, 5:A,B, C,D,E,F
650607 00 01	Complete carrier	

Item-no.	Description	Info
<b>R 80 G/S (1981-1987)</b>		
650611 00 01	Complete carrier	49
650611 01 01	Rear rack	88
<b>R 80 GS (1988-1994)</b>		
650608 00 01	Side carrier	0,20,91
650609 00 01	Side carrier	20, 49
650608 01 01	Rear rack	91
<b>R 80 GS Basic (1996)</b>		
650623 00 01	Complete carrier	0
650623 01 01	Rear rack	88
<b>R 80 RT (1981-1985)</b>		
650602 00 01	Complete carrier	16
650602 00 02	Complete carrier	16
<b>R 80 RT (1986-1995)</b>		
650605 00 02	Complete carrier	17
650605 01 01	Rear rack	22
650605 01 02	Rear rack	22
<b>R 80 ST (1982-1984)</b>		
650601 00 01	Complete carrier	0, 5:A,B, C,D,E,F

### NOTICE Tank rings BMW

Our tank ring Lock-it 506003-6 / Basic 516003-6 fits all BMW models with 6 hole mounting.

506003-6 Tank ring Lock-it 6 hole

516003-6 Tank ring Basic 6 hole

Our tank ring Lock-it 506002-5 / Basic 516002-5 fits all BMW models with 5 hole mounting.

506002-5 Tank ring Lock-it 5 hole

516002-5 Tank ring Basic 5 hole

Our tank ring Lock-it 506005-0 / Basic 516005-0 fits all BMW models with inner mounting.

506005-0 Tank ring Lock-it inner mounting

516005-0 Tank ring Basic inner mounting

Item-no.	Description	Info
<b>F 850 GS (2018-)</b>		
6556513 01 01	Alurack	
6626513 01 01	Easyrack	
6606513 01 01	Minirack	
6526513 01 01	Alurack	157
6616513 01 01	Easyrack	157
6506513 00 01	Side carrier Lock-it	0
6516513 00 22	Cutout Carrier	4:C3,C4
6516513 00 22-00-40	Xplorer Cutout Set	
6516513 00 22-01-40	Xplorer Cutout Set	
5016513 00 22	Engine guard	
5026513 00 22	Tank guard	
5016513 00 01	Engine guard	
5026513 00 01	Tank guard	
640100 00 01	Crash bar bag set V1	
7006513 00 01	Headlight grilles	112
42126513 00 01	Handle guard	
5066513 00 01	Tank ring Lock-it	902
5166513 00 01	Tank ring Basic	702
42116513 00 91	Side stand enlargement	
8106513 00 12	Skid plate	
6306513 00 01	C-Bow Holder	181
731107	LED auxiliary headlights Nova	133
5046513 00 01	Rear Guard	
8006513 00 01	Rear rack enlargement	
8016513 00 01	Rear rack enlargement	191
741100 00 01	Tool box	

Item-no.	Description	Info
<b>F 850 GS Adventure (2019-)</b>		
6526520 01 01	Alurack	
6616520 01 01	Easyrack	
8006520 00 01	Rear rack enlargement	
6506520 00 01	Side carrier Lock-it	0
6516520 00 22	Cutout Carrier	4:C3,C4
6516520 00 22-00-40	Xplorer Cutout Set	
6516520 00 22-01-40	Xplorer Cutout Set Black	
5066520 00 01	Tank ring Lock-it	902
5166520 00 01	Tank ring Basic	702
42116520 00 91	Side stand enlargement	
7006520 00 01	Headlight grilles	112
731107	LED auxiliary headlights Nova	133
6306520 00 01	C-Bow Holder	181
8106520 00 12	Skid plate	
<b>R 850 C (2000-2004)</b>		
650624 00 02	Side carrier	
650624 01 02	Rear rack	27,54
630624 00 02	C-Bow Holder	
625624 00 02	Leather bag holder tube type	
506624 00 01	Tank ring Lock-it	902
516624 00 01	Tank ring Basic	702
502907 00 02	Engine guard	
400624 00 02	Twinlight Set	
410624 00 02	Fender Guard	
<b>R 80 R (1991-1996)</b>		
650614 00 02	Side carrier	3:B1,B2
650614 01 01	Rear rack	
650614 01 02	Rear rack	

**ATTENTION: You can find the new 2024 models online at [www.hepco-becker.de](http://www.hepco-becker.de)**



Item-no.	Description	Info
<b>R 850 GS (1998-2000)</b>		
650620 00 01	Side carrier	0,5:C
650620 01 01	Rear rack	9
650620 01 09	Rear rack	9
502901 00 01	Engine guard	
502901 00 02	Engine guard	
502901 00 09	Engine guard	
502903 00 01	Tank guard	65
502903 00 02	Tank guard	65
502903 00 09	Tank guard	65
700620 00 01	Headlight grilles	112
502904 00 01	Headlight grilles	65, 112
506901 00 01	Tank ring Lock-it	902
516901 00 01	Tank ring Basic	702
<b>R 850 R (1994-2002)</b>		
650621 00 01	Side carrier	0
506621 00 01	Tank ring Lock-it	902
516621 00 01	Tank ring Basic	702
650621 01 01	Rear rack	
650629 01 01	Rear rack	9
502902 00 01	Engine guard	
502902 00 02	Engine guard	
<b>R 850 R (2003-2006)</b>		
650631 00 01	Side carrier	
506621 00 01	Tank ring Lock-it	902
516621 00 01	Tank ring Basic	702
650631 01 01	Rear rack	
650632 01 01	Rear rack	47
650629 01 01	Rear rack	9
502913 00 01	Engine guard	
502913 00 02	Engine guard	

Item-no.	Description	Info
<b>F 900 R (2020-)</b>		
6526524 01 01	Alurack	
6616524 01 01	Easyrack	
6556524 01 01	Alurack f. Original rack	
6626524 01 01	Easyrack f. Original rack	
6606524 01 01	Minirack	
6306524 00 01	C-Bow Holder	
5016524 00 01	Engine guard incl. Protectionpad	171
5066524 00 01	Tank ring Lock-it	
5166524 00 01	Tank ring Basic	
42116524 00 91	Side stand enlargement	
5036524 00 01	Front Guard	
5046524 00 01	Rear Guard	202
<b>F 900 XR (2020-)</b>		
6506525 00 01	Side carrier Lock-it	
6526525 01 01	Alurack	
6616525 01 01	Easyrack	
6556525 01 01	Alurack f. Original rack	
6626525 01 01	Easyrack f. Original rack	
6606525 01 01	Minirack	
6306525 00 01	C-Bow Holder	
5016525 00 01	Engine guard incl. Protectionpad	171
5066525 00 01	Tank ring Lock-it	
5166525 00 01	Tank ring Basic	
42116525 00 91	Side stand enlargement	
5036525 00 01	Front Guard	
5046525 00 01	Rear Guard	202
<b>R 90/6 (1973-1976)</b>		
650613 00 02	Complete carrier	
<b>K 1 (1989-1993)</b>		
650612 01 01	Rear rack	13
<b>K 100 RS (1983-1989)</b>		
650603 00 01	Complete carrier	
650603 01 01	Rear rack	22

Item-no.	Description	Info
<b>K 100 RT (1983-1989)</b>		
650603 00 01	Complete carrier	
650603 01 01	Rear rack	22
<b>K 100 RS (1990-1992)</b>		
650610 00 01	Complete carrier	
650610 01 01	Rear rack	22
<b>K 100 RT (1990-1992)</b>		
650610 00 01	Complete carrier	
650610 01 01	Rear rack	22
<b>R 100 / 7 (1976-1985)</b>		
650602 00 01	Complete carrier	16
650602 00 02	Complete carrier	16
<b>R 100 CS Bj. 1980-1985</b>		
650602 00 01	Complete carrier	16
650602 00 02	Complete carrier	16
<b>R 100 RS (1976-1985)</b>		
650602 00 01	Complete carrier	16
650602 00 02	Complete carrier	16
<b>R 100 RT (1978-1985)</b>		
650602 00 01	Complete carrier	16
650602 00 02	Complete carrier	16

### NOTICE Tank rings BMW

Our tank ring Lock-it 506003-6 / Basic 516003-6 fits all BMW models with 6 hole mounting.

506003-6 Tank ring Lock-it 6 hole

516003-6 Tank ring Basic 6 hole

Our tank ring Lock-it 506002-5 / Basic 516002-5 fits all BMW models with 5 hole mounting.

506002-5 Tank ring Lock-it 5 hole

516002-5 Tank ring Basic 5 hole

Our tank ring Lock-it 506005-0 / Basic 516005-0 fits all BMW models with inner mounting.

506005-0 Tank ring Lock-it inner mounting

516005-0 Tank ring Basic inner mounting

Item-no.	Description	Info
<b>R 100 RT/RS (1986-1995)</b>		
650605 00 02	Complete carrier	17
650605 01 01	Rear rack	22
650605 01 02	Rear rack	22
<b>R 100 GS (1987-1994)</b>		
650608 00 01	Side carrier	0,20,91
650608 01 01	Rear rack	91
<b>R 100 GS Paris-Dakar (1989-1996)</b>		
650608 00 01	Side carrier	0,20,91
650608 01 01	Rear rack	91
<b>R 100 GS Paris-Dakar (1989-1996)</b>		
650609 00 01	Side carrier	20, 49
650609 01 01	Rear rack	
<b>R 100 R (1991-1996)</b>		
650614 00 02	Side carrier	3:B1,B2
650614 01 01	Rear rack	
650614 01 02	Rear rack	
<b>R 100 R Mystic (1994-1996)</b>		
650619 00 02	Complete carrier	
650619 01 02	Rear rack	22,51
<b>M 1000 R (2023-)</b>		
6306531 00 01	C- Bow holder	
6706531 00 01	Sportrack	
8006531 00 01	Rear rack enlargement	
5066531 00 01	Tank ring Lock-it	903
5166531 00 01	Tank ring Basic	703
<b>S 1000 R (2014-2020)</b>		
630670 00 01	C-Bow Holder	
670670 00 01	Sportrack	52,92
800670 00 01	Rear rack enlargement for Sportrack 670670	
506670 00 01	Tank ring Lock-it	169,903
516670 00 01	Tank ring Basic	169,703



**ATTENTION: You can find the new 2024 models online at [www.hepco-becker.de](http://www.hepco-becker.de)**



Item-no.	Description	Info	Item-no.	Description	Info	Item-no.	Description	Info	Item-no.	Description	Info
<b>S 1000 R (2021-)</b>			<b>S 1000 XR (2015-2019)</b>			<b>R 1100 GS (1994-1999)</b>			<b>R 1150 GS (2000-2004)</b>		
6306528 00 01	C-Bow holder	27, 4:G, I,J	650675 00 01	Side carrier Lock-it		650620 00 01	Side carrier	0,5:C	650626 00 01	Side carrier	0,5:C
6706528 00 01	Sportrack	52,92, 169	650675 01 01	Alurack		650620 01 01	Rear rack	9	650626 01 01	Rear rack	9
8006528 00 01	Rear rack enlargement f. Sportrack 6706528	184	655675 01 01	Alurack f. Original rack		650620 01 09	Rear rack	9	650626 01 09	Rear rack	9
5066528 00 01	Tank ring Lock-it	903, 3:16	661675 01 01	Easyrack		800626 00 01	Rear rack enlargement		800626 00 01	Rear rack enlargement	
5166528 00 01	Tank ring Basic	703, 3:16	662675 01 01	Easyrack f. Original rack		502901 00 01	Engine guard		502908 00 01	Engine guard	
<b>S 1000 RR (2009-2011)</b>			630675 00 01	C-Bow Holder		502901 00 02	Engine guard		502908 00 02	Engine guard	
630600 00 01	C-Bow Holder	27	506675 00 01	Tank ring Lock-it	902	502901 00 09	Engine guard		502908 00 09	Engine guard	
670600 00 01	Sportrack	52,92	516675 00 01	Tank ring Basic	702	502903 00 01	Tank guard	65	502909 00 01	Tank guard	65
800600 00 01	Rear rack enlargement for Sportrack		4211675 00 91	Side stand enlargement		502903 00 02	Tank guard	65	502909 00 02	Tank guard	65
506600 00 01	Tank ring Lock-it	169,903	4212675 00 01	Handle guard		502903 00 09	Tank guard	65	502909 00 09	Tank guard	65
516600 00 01	Tank ring Basic	169,703	<b>S 1000 XR (2020-)</b>			700620 00 01	Headlight grilles	112	700634 00 01	Headlight grilles	112
<b>S 1000 RR (2012-2015)</b>			6506526 00 01	Side carrier		502904 00 01	Headlight grilles	65, 112	506908 00 01	Tank ring Lock-it	902
630664 00 01	C-Bow Holder	27	6526526 01 01	Alurack	56	506901 00 01	Tank ring Lock-it	902	516908 00 01	Tank ring Basic	702
670664 00 01	Sportrack	52,92	6616526 01 01	Easyrack	56	516901 00 01	Tank ring Basic	702			
800664 00 01	Rear rack enlargement for Sportrack		6606526 01 01	Minirack	56	<b>R 1150 R (2000-2006)</b>					
506664 00 01	Tank ring Lock-it	169,903	6306526 00 01	C-Bow Holder	86	650631 00 01	Side carrier				
516664 00 01	Tank ring Basic	169,703	5016526 00 01	Engine guard incl. Protectionpad		650631 01 01	Rear rack				
<b>S 1000 RR (2016-2018)</b>			5066526 00 01	Tank ring Lock-it		650632 01 01	Rear rack	47			
6306503 00 01	C-Bow Holder	4:1	5166526 00 01	Tank ring Basic		502913 00 01	Engine guard				
6706503 00 01	Sportrack	52,92	42116526 00 91	Side stand enlargement		502913 00 02	Engine guard				
5066503 00 01	Tank ring Lock-it	169,903	42126526 00 01	Handle guard		506913 00 01	Tank ring Lock-it	902			
5166503 00 01	Tank ring Basic	169,703	6556526 01 01	Alurack f. Original rack		516913 00 01	Tank ring Basic	702			
8006503 00 01	Rear rack enlargement for Sportrack		6626526 01 01	Easyrack f. Original rack		<b>R 1150 RT (2001-2004) / RS (2001-2005)</b>					
<b>S 1000 RR (2019-)</b>			<b>R 1100 R (1994-1999)</b>			650630 01 01	Rear rack	9			
6306517 00 01	C-Bow Holder	27, 3:H, K2	650621 00 01	Side carrier	0	506630 00 01	Tank ring Lock-it	902			
5066517 00 01	Tank ring Lock-it	903	650621 01 01	Rear rack		516630 00 01	Tank ring Basic	702			
5166517 00 01	Tank ring Basic	703	650629 01 01	Rear rack	9						
6706517 00 01	Sportrack	52,92, 169	502902 00 01	Engine guard							
			502902 00 02	Engine guard							
			<b>R 1100 RT (1996-2001) / RS (1993-2001)</b>								
			650630 01 01	Rear rack	9						

### NOTICE Tank rings BMW

Our tank ring Lock-it 506003-6 / Basic 516003-6 fits all BMW models with 6 hole mounting.

506003-6 Tank ring Lock-it 6 hole

516003-6 Tank ring Basic 6 hole

Our tank ring Lock-it 506002-5 / Basic 516002-5 fits all BMW models with 5 hole mounting.

506002-5 Tank ring Lock-it 5 hole

516002-5 Tank ring Basic 5 hole

Our tank ring Lock-it 506005-0 / Basic 516005-0 fits all BMW models with inner mounting.

506005-0 Tank ring Lock-it inner mounting

516005-0 Tank ring Basic inner mounting



**ATTENTION: You can find the new 2024 models online at [www.hepco-becker.de](http://www.hepco-becker.de)**



Info reference see p. 271

The last digit of the item-no. refers to the colours: 01= black 02= chrome 03= white 04= red 05= anthracite 06= orange 08= yellow 09= silver 10= blue metallic 12= Alu brushed 22= Stainless steel 91= silver/black

Item-no.	Description	Info
<b>R 1150 GS Adventure (2001-2005)</b>		
650634 00 01	Side carrier	0,5:C
650634 01 09	Rear rack	53
800634 00 09	Rear rack enlargement	
502915 00 01	Engine guard	
502915 00 02	Engine guard	
502915 00 09	Engine guard	
502916 00 01	Tank guard	65
502916 00 09	Tank guard	65
700634 00 01	Headlight grilles	112
506915 00 01	Tank ring Lock-it	902
516915 00 01	Tank ring Basic	702
<b>R 1200 CL (2002-2005)</b>		
502917 00 02	Engine guard	
<b>HP 2 (2005-2008)</b>		
650645 01 01	Alurack	
661645 01 01	Easyrack	
660645 01 01	Minirack	
506645 00 01	Tank ring Lock-it	902
516645 00 01	Tank ring Basic	702
700645 00 01	Headlight grilles	112
<b>K 1200 RS / GT (1996-2005)</b>		
650636 01 01	Rear rack	88
506636 00 01	Tank ring Lock-it	902
516636 00 01	Tank ring Basic	702
<b>K 1200 GT03 (-2008)</b>		
506003-6	Tank ring Lock-it	
516003-6	Tank ring Basic	
<b>K 1200 R (2005-2008)</b>		
650641 00 01	Side carrier	
650641 01 01	Rear rack	
630641 00 01	C-Bow Holder	
502923 00 01	Engine guard	
506923 00 01	Tank ring Lock-it	902
516923 00 01	Tank ring Basic	702

Item-no.	Description	Info
<b>K 1200 R Sport (2007-2008)</b>		
650641 00 01	Side carrier	
650641 01 01	Rear rack	
630641 00 01	C-Bow Holder	
506641 00 01	Tank ring Lock-it	902
516641 00 01	Tank ring Basic	702
<b>K 1200 S (2004-2008)</b>		
650639 00 01	Side carrier	
650639 01 01	Alurack	
661639 01 01	Easyrack	
630639 00 01	C-Bow Holder	
506639 00 01	Tank ring Lock-it	902
516639 00 01	Tank ring Basic	702
<b>R 1200 C (1997-2004)</b>		
650624 00 02	Side carrier	
650624 01 02	Rear rack	27,54
630624 00 02	C-Bow Holder	
625624 00 02	Leather bag holder tube type	
502907 00 02	Engine guard	
400624 00 02	Twinlight Set	
410624 00 02	Fender Guard	
<b>R 1200 ST (2005-2007)</b>		
650643 01 09	Rear rack	
506643 00 01	Tank ring Lock-it	902
516643 00 01	Tank ring Basic	702
4211643 00 91	Side stand enlargement	
<b>R 1200 RT (2005-2013)</b>		
506640 00 01	Tank ring Lock-it	902
516640 00 01	Tank ring Basic	702
4211640 00 91	Side stand enlargement	
<b>R 1200 RT (2014-2018)</b>		
506673 00 01	Tank ring Lock-it	902
516673 00 01	Tank ring Basic	702
650673 01 01	Alurack	
661673 01 01	Easyrack	

Item-no.	Description	Info
<b>R nineT (2014-)</b>		
650669 01 01	Alurack	
661669 01 01	Easyrack	
660669 01 01	Minirack	10
630669 00 01	C-Bow Holder	27,84
653669 00 01	Side carrier	3: H
654669 01 01	Rear rack tube type	141
4219669 00 01	Railing / Pillion handle	96
501669 00 01	Engine guard	
501669 00 09	Engine guard	
810669 00 12	Skid plate	
4211669 00 91	Side stand enlargement (-2016)	
42116502 00 91	Side stand enlargement (2017-)	
506669 00 01	Tank ring Lock-it	
516669 00 01	Tank ring Basic	
7006502 00 01	Headlight grilles	112

Item-no.	Description	Info
<b>R nineT Scrambler (2016-)</b>		
6526502 01 01	Alurack	
6616502 01 01	Easyrack	
6606502 01 01	Minirack	10
6306502 00 01	C-Bow Holder	27
6316502 00 01R	C-Bow Holder, one-sided	27
5016502 00 01	Engine guard	
5016502 00 09	Engine guard	
8106502 00 12	Skid plate	
42116502 00 91	Side stand enlargement	
5066502 00 01	Tank ring Lock-it	
5166502 00 01	Tank ring Basic	
6546502 01 01	Rear rack tube type	141
42196502 00 01	Railing / Pillion handle	96
7006502 00 01	Headlight grilles	112
<b>R nineT Pure (2017-)</b>		
6306504 00 01	C-Bow Holder	27,84
6536504 00 01	Side carrier	3: H
6526504 01 01	Alurack	
6616504 01 01	Easyrack	
6606504 01 01	Minirack	10
6546504 01 01	Rear rack tube type	141
5016504 00 01	Engine guard	
5016504 00 09	Engine guard	
8106504 00 12	Skid plate	
42116504 00 91	Side stand enlargement	
5066504 00 01	Tank ring Lock-it	
5166504 00 01	Tank ring Basic	
42196504 00 01	Pillion handle	96
7006504 00 01	Headlight grilles	112

### NOTICE Tank rings BMW

Our tank ring Lock-it 506003-6 / Basic 516003-6 fits all BMW models with 6 hole mounting.

506003-6 Tank ring Lock-it 6 hole

516003-6 Tank ring Basic 6 hole

Our tank ring Lock-it 506002-5 / Basic 516002-5 fits all BMW models with 5 hole mounting.

506002-5 Tank ring Lock-it 5 hole

516002-5 Tank ring Basic 5 hole

Our tank ring Lock-it 506005-0 / Basic 516005-0 fits all BMW models with inner mounting.

506005-0 Tank ring Lock-it inner mounting

516005-0 Tank ring Basic inner mounting



**ATTENTION: You can find the new 2024 models online at [www.hepco-becker.de](http://www.hepco-becker.de)**



Item-no.	Description	Info	Item-no.	Description	Info	Item-no.	Description	Info	Item-no.	Description	Info
<b>R nineT Racer (2017-)</b>			<b>R 1200 GS (2004-2007)</b>			<b>R 1200 GS (2008-2012)</b>			<b>R 1200 GS Adventure (2006-2013)</b>		
6306505 00 01	C-Bow Holder	27,84	650649 00 01	Side carrier Lock-it	0	650655 00 01	Side carrier Lock-it	0	650651 00 01	Side carrier Lock-it	0
6526505 01 01	Alurack		650649 00 09	Side carrier Lock-it	0	650655 00 09	Side carrier Lock-it	0	650651 00 09	Side carrier Lock-it	0
6616505 01 01	Easyrack		650637 00 01	Side carrier	0,95	650637 00 01	Side carrier	0,95	650644 00 01	Side carrier	0,95
6606505 01 01	Minirack	10	650637 00 09	Side carrier	0,95	650637 00 09	Side carrier	0,95	650644 00 09	Side carrier	0,95
6546505 01 01	Rear rack tube type	141	651637 00 22	Cutout Carrier	4:C3,C4	651637 00 22	Cutout Carrier	4:C3,C4	650651 01 01	Rear rack	
5016505 00 01	Engine guard		651637 00 22-00-40	Xplorer Cutout Set		651637 00 22-00-40	Xplorer Cutout Set		650651 01 09	Rear rack	
5016505 00 09	Engine guard		651637 00 22-01-40	Xplorer Cutout Set Black		651637 00 22-01-40	Xplorer Cutout Set Black		810637 00 12	Skid plate	
8106505 00 12	Skid plate		650649 01 01	Alurack	69	650655 01 01	Alurack	69	700644 00 01	Headlight grilles	112
42116505 00 91	Side stand enlargement		650649 01 09	Alurack	69	650655 01 09	Alurack	69	420655-01	Handle guard	83
5066505 00 01	Tank ring Lock-it		661649 01 01	Easyrack	69	661655 01 01	Easyrack	69	506644 00 01	Tank ring Lock-it	903
5166505 00 01	Tank ring Basic		661649 01 09	Easyrack	117,69	661655 01 09	Easyrack	84,117	516644 00 01	Tank ring Basic	703
42196505 00 01	Railing	96	650637 01 01	Rear rack		650637 01 01	Rear rack		4211644 00 91	Side stand enlargement	
<b>R nineT Urban G/S (2017-)</b>			650637 01 09	Rear rack		650637 01 09	Rear rack		640003 00 00	Small Sport Star Rack	104
6306506 00 01	C-Bow Holder	27,84	630655 00 01	C-Bow Holder		630655 00 01	C-Bow Holder				
6536506 00 01	Side carrier	1, 3: H	800637 00 09	Rear rack enlargement		800637 00 09	Rear rack enlargement				
6526506 01 01	Alurack		502918 00 01	Engine guard		502918 00 01	Engine guard				
6616506 01 01	Easyrack		502918 00 09	Engine guard		502918 00 09	Engine guard				
6606506 01 01	Minirack	10	502922 00 01	Tank guard	65	502926 00 01	Tank guard	65			
5016506 00 01	Engine guard		502922 00 09	Tank guard	65	502926 00 09	Tank guard	65			
5016506 00 09	Engine guard		640100 00 01	Crash bar bag set V1		640100 00 01	Crash bar bag set V1				
8106506 00 12	Skid plate		810637 00 12	Skid plate		810637 00 12	Skid plate				
42116506 00 91	Side stand enlargement		700644 00 01	Headlight grilles	112	700644 00 01	Headlight grilles	112			
5066506 00 01	Tank ring Lock-it		731107	LED auxiliary headlights Nova	133	731637 00 01	Auxiliary headlights	133			
5166506 00 01	Tank ring Basic		705211 00 09	Reinforcement brace set		705211 00 09	Reinforcement brace set				
6546506 01 01	Rear rack tube type	141	506918 00 01	Tank ring Lock-it	902	420655-01	Handle guard	83			
7006506 00 01	Headlight grilles	112	516918 00 01	Tank ring Basic	702	506926 00 01	Tank ring Lock-it	903			
42196506 00 01	Railing	96	640003 00 00	Small Sport Star Rack	104	516926 00 01	Tank ring Basic	703			
						4211655 00 91	Side stand enlargement				
						640003 00 00	Small Sport Star Rack	104			

### NOTICE Tank rings BMW

Our tank ring Lock-it 506003-6 / Basic 516003-6 fits all BMW models with 6 hole mounting.

506003-6 Tank ring Lock-it 6 hole

516003-6 Tank ring Basic 6 hole

Our tank ring Lock-it 506002-5 / Basic 516002-5 fits all BMW models with 5 hole mounting.

506002-5 Tank ring Lock-it 5 hole

516002-5 Tank ring Basic 5 hole

Our tank ring Lock-it 506005-0 / Basic 516005-0 fits all BMW models with inner mounting.

506005-0 Tank ring Lock-it inner mounting

516005-0 Tank ring Basic inner mounting



**ATTENTION: You can find the new 2024 models online at [www.hepco-becker.de](http://www.hepco-becker.de)**



Info reference see p. 271

The last digit of the item-no. refers to the colours: 01= black 02= chrome 03= white 04= red 05= anthracite 06= orange 08= yellow 09= silver 10= blue metallic 12= Alu brushed 22= Stainless steel 91= silver/black

Item-no.	Description	Info
<b>R 1200 GS LC (2013-2018)</b>		
650665 00 01	Side carrier Lock-it	0
650665 00 05	Side carrier Lock-it	0
650665 00 09	Side carrier Lock-it	0
651665 00 22	Cutout Carrier	4:C3,C4
651665 00 22-00-40	Xplorer Cutout Set	
651665 00 22-01-40	Xplorer Cutout Set black	
650665 01 01	Alurack	
650665 01 09	Alurack	
6526521 01 01	Alurack	
661665 01 01	Easyrack	
6616521 01 01	Easyrack	235
4210665 00 01	Reinforcement for original rear	63
630665 00 01	C-Bow Holder	
660665 01 05	Minirack	10,72
6606521 01 01	Minirack	235
800665 00 05	Rear rack enlargement	
501668 00 01	Engine guard	
501668 00 09	Engine guard	
501668 00 22	Engine guard	
4222668 00 01	Reinforcement bracket Offroad (for 501668)	
4222668 00 22	Reinforcement bracket Offroad (for 501668)	
4222668 00 09	Reinforcement bracket Offroad (for 501668)	
502668 00 01	Tank guard	120,179
502668 00 05	Tank guard	120,179
502668 00 09	Tank guard	120,179
502668 00 22	Tank guard	120,179
640100 00 01	Crash bar bag set V1	
5026508 00 01	Tank guard (2017-)	120,179
5026508 00 22	Tank guard (2017-)	120,179
5026508 00 09	Tank guard (2017-)	120,179
5026508 00 05	Tank guard (2017-)	120,179

Item-no.	Description	Info
640100 00 01	Crash bar bag set V1	
810665 00 09	Skid plate	
700665 00 01	Headlight grilles (-2013)	110,112
700671 00 01	Headlight grilles (2014-2016)	112
7006508 00 01	Headlight grilles (2017-)	112
4213668 00 01	Holder BMW Auxiliary headlights	
731107	LED auxiliary headlights Nova	133
420665-01	Kardan protection	
420665-02	Center stand guard	
420665-03	Handle guard	
4212665 00 10	Handle guard	
420665-04	Heat shield for case	
506668 00 01	Tank ring Lock-it	902
516668 00 01	Tank ring Basic	702
4211665 00 91	Side stand enlargement (-2016)	
42116508 00 91	Side stand enlargement (2017-)	
640003 00 00	Small Sport Star Rack	104
741665 00 01	Tool box	
670665 00 01	Sportrack	52,169

### NOTICE Tank rings BMW

Our tank ring Lock-it 506003-6 / Basic 516003-6 fits all BMW models with 6 hole mounting.

506003-6 Tank ring Lock-it 6 hole

516003-6 Tank ring Basic 6 hole

Our tank ring Lock-it 506002-5 / Basic 516002-5 fits all BMW models with 5 hole mounting.

506002-5 Tank ring Lock-it 5 hole

516002-5 Tank ring Basic 5 hole

Our tank ring Lock-it 506005-0 / Basic 516005-0 fits all BMW models with inner mounting.

506005-0 Tank ring Lock-it inner mounting

516005-0 Tank ring Basic inner mounting



**ATTENTION: You can find the new 2024 models online at [www.hepco-becker.de](http://www.hepco-becker.de)**

Item-no.	Description	Info
<b>R 1200 GS Adventure (2014-2018)</b>		
650671 00 01	Side carrier Lock-it	0
650671 00 05	Side carrier Lock-it	0
650671 00 09	Side carrier Lock-it	0
651671 00 22	Cutout Carrier	4:C3,C4
651671 00 22-00-40	Xplorer Cutout Set	
651671 00 22-01-40	Xplorer Cutout Set black	
650671 01 01	Alurack	
661671 01 01	Easyrack	
800671 00 01	Rear rack enlargement	
630671 00 01	C-Bow Holder	
810671 00 09	Skid plate	
700671 00 01	Headlight grilles	112
731107	LED auxiliary headlights Nova	133
420671-01	Kardan protection	
420671-02	Center stand guard	
420671-03	Handle guard	
4212671 00 10	Handle guard	
420671-04	Heat shield for case	
506671 00 01	Tank ring Lock-it	902
516671 00 01	Tank ring Basic	702
4211671 00 91	Side stand enlargement	79
42116521 00 91	Side stand enlargement	165
640003 00 00	Small Sport Star Rack	104
741671 00 01	Tool box	
670671 00 01	Sportrack	52,169

Item-no.	Description	Info
<b>R 1200 R (2006-2010)</b>		
650648 00 01	Side carrier Lock-it	99
650648 01 01	Rear rack	68
630648 00 01	C-Bow Holder	
502924 00 01	Engine guard	
502924 00 09	Engine guard	
506648 00 01	Tank ring Lock-it	903
516648 00 01	Tank ring Basic	703
4211648 00 91	Side stand enlargement	
<b>R 1200 R / Classic (2011-2014)</b>		
650661 00 01	Side carrier Lock-it	99
650658 01 01	Alurack f. original rack	104
661658 01 01	Easyrack f. original rack	104
650661 01 01	Rear rack	68
630648 00 01	C-Bow Holder	
502661 00 01	Engine guard	
502661 00 09	Engine guard	
506661 00 01	Tank ring Lock-it	903
516661 00 01	Tank ring Basic	703
4211661 00 91	Side stand enlargement	



Item-no.	Description	Info
<b>R 1200 R (2015-2018)</b>		
650676 00 01	Side carrier Lock-it	
650676 01 01	Alurack	
650678 01 01	Alurack f. Original rack	
661676 01 01	Easyrack	
661678 01 01	Easyrack f. Original rack	
630676 00 01	C-Bow Holder	
501676 00 01	Engine guard	
501676 00 09	Engine guard	
4222668 00 01	Reinforcement bracket Offroad (for 501676)	
4222668 00 22	Reinforcement bracket Offroad (for 501676)	
4222668 00 09	Reinforcement bracket Offroad (for 501676)	
800676 00 01	Rear rack enlargement	104
420676-01	Kardan protection	
506676 00 01	Tank ring Lock-it	902
516676 00 01	Tank ring Basic	702
4211676 00 91	Side stand enlargement	

Item-no.	Description	Info
<b>R 1200 RS (2015-2018)</b>		
650677 00 01	Side carrier Lock-it	
650677 01 01	Alurack	
650679 01 01	Alurack f. Original rack	
661677 01 01	Easyrack	
661679 01 01	Easyrack f. Original rack	
630677 00 01	C-Bow Holder	
501677 00 01	Engine guard	
501677 00 09	Engine guard	
4222668 00 01	Reinforcement bracket Offroad (for 501677)	
4222668 00 22	Reinforcement bracket Offroad (for 501677) Stainless steel	
4222668 00 09	Reinforcement bracket Offroad (for 501677) silver	
800677 00 01	Rear rack enlargement	104
420677-01	Kardan protection	
506677 00 01	Tank ring Lock-it	902
516677 00 01	Tank ring Basic	702
4211677 00 91	Side stand enlargement	

Item-no.	Description	Info
<b>R 1250 GS (2018-)</b>		
6506514 00 01	Side carrier Lock-it	0
6506514 00 05	Side carrier Lock-it	0
6506514 00 09	Side carrier Lock-it	0
6516514 00 22	Cutout Carrier	4:C3,C4
6516514 00 22-00-40	Xplorer Cutout Set	
6516514 00 22-01-40	Xplorer Cutout Set black	
6556514 01 01	Alurack f. Original rack	
6556514 01 09	Alurack f. Original rack	
6626514 01 01	Easyrack f. Original rack	
6526521 01 01	Alurack	235
6616521 01 01	Easyrack	235
6306514 00 01	C-Bow Holder	
6606514 01 05	Minirack	13,72
6706514 00 01	Sportrack	52,169, 236
6606521 01 01	Minirack	235
8006514 00 05	Rear rack enlargement	
5016514 00 01	Engine guard	191
5016514 00 05	Engine guard	191
5016514 00 09	Engine guard	191
5016514 00 22	Engine guard	191
42226514 00 01	Reinforcement bracket Offroad (for 5016514)	
42226514 00 05	Reinforcement bracket Offroad (for 5016514)	
42226514 00 09	Reinforcement bracket Offroad (for 5016514)	
42226514 00 22	Reinforcement bracket Offroad (for 5016514)	
5026514 00 01	Tank guard	120, 179
5026514 00 05	Tank guard	120, 179
5026514 00 09	Tank guard	120, 179
5026514 00 22	Tank guard	120, 179
640100 00 01	Crash bar bag set V1	

Item-no.	Description	Info
8106514 00 12	Skid plate	
7006514 00 01	Headlight grilles	112
4213668 00 01	Holder BMW Auxiliary headlights	
731107	LED auxiliary headlights Nova	133
42256514 00 22	Heat shield for case	
42176514 00 12	Center stand guard	
42126514 00 01	Handle guard	
42126514 00 10	Handle guard	
42126521 00 10	Handle guard (HP-Version)	
42126514 00 08	Handle guard	
5066514 00 01	Tank ring Lock-it	902
5166514 00 01	Tank ring Basic	702
42116514 00 91	Side stand enlargement	79
42116521 00 91	Side stand enlargement	165
640003 00 00	Small Sport Star Rack	104
7416514 00 01	Tool box	
42246514 00 01	Kardan protection	
42106514 00 01	Reinforcement for original rear	63

## NOTICE Tank rings BMW

Our tank ring Lock-it 506003-6 / Basic 516003-6 fits all BMW models with 6 hole mounting.

506003-6 Tank ring Lock-it 6 hole

516003-6 Tank ring Basic 6 hole

Our tank ring Lock-it 506002-5 / Basic 516002-5 fits all BMW models with 5 hole mounting.

506002-5 Tank ring Lock-it 5 hole

516002-5 Tank ring Basic 5 hole

Our tank ring Lock-it 506005-0 / Basic 516005-0 fits all BMW models with inner mounting.

506005-0 Tank ring Lock-it inner mounting

516005-0 Tank ring Basic inner mounting



**ATTENTION: You can find the new 2024 models online at [www.hepco-becker.de](http://www.hepco-becker.de)**



Info reference see p. 271

The last digit of the item-no. refers to the colours: 01= black 02= chrome 03= white 04= red 05= anthracite 06= orange 08= yellow 09= silver 10= blue metallic 12= Alu brushed 22= Stainless steel 91= silver/black

Item-no.	Description	Info
<b>R 1250 GS Adventure (2019-)</b>		
6506519 00 01	Side carrier Lock-it	
6506519 00 05	Side carrier Lock-it	
6506519 00 09	Side carrier Lock-it	
6516519 00 22	Cutout Carrier	4:C3,C4
6516519 00 22-00-40	Xplorer Cutout Set	
6516519 00 22-01-40	Xplorer Cutout Set Black	
6526519 01 01	Alurack	
6616519 01 01	Easyrack	
6306519 00 01	C-Bow Holder	
8006519 00 01	Rear rack enlargement	
8106519 00 12	Skid plate	
7006519 00 01	Headlight grilles	112
731107	LED auxiliary headlights Nova	133
42256519 00 22	Heat shield for case	
42176519 00 12	Center stand guard	
42126519 00 01	Handle guard	
42126519 00 10	Handle guard	
42126519 00 08	Handle guard	
5066519 00 01	Tank ring Lock-it	902
5166519 00 01	Tank ring Basic	702
42116519 00 91	Side stand enlargement	
640003 00 00	Small Sport Star Rack	
7416519 00 01	Tool box	
42246519 00 01	Kardan protection	
6706519 00 01	Sportrack	52,169

Item-no.	Description	Info
<b>R 1250 RS (2019-)</b>		
6506515 00 01	Side carrier Lock-it	
6526515 01 01	Alurack	
6556515 01 01	Alurack f. Original rack	
6616515 01 01	Easyrack	
6626515 01 01	Easyrack f. Original rack	
6306515 00 01	C-Bow Holder	
5016515 00 01	Engine guard	171
5016515 00 09	Engine guard	171
42226515 00 01	Reinforcement bracket for Off-road (for 5016515)	
42226515 00 05	Reinforcement bracket for Off-road (for 5016515)	
42226515 00 09	Reinforcement bracket for Off-road (for 5016515)	
8006515 00 01	Rear rack enlargement	
42246515 00 01	Kardan protection	
5066515 00 01	Tank ring Lock-it	902
5166515 00 01	Tank ring Basic	702
42116515 00 91	Side stand enlargement	

### NOTICE Tank rings BMW

Our tank ring Lock-it 506003-6 / Basic 516003-6 fits all BMW models with 6 hole mounting.

506003-6 Tank ring Lock-it 6 hole

516003-6 Tank ring Basic 6 hole

Our tank ring Lock-it 506002-5 / Basic 516002-5 fits all BMW models with 5 hole mounting.

506002-5 Tank ring Lock-it 5 hole

516002-5 Tank ring Basic 5 hole

Our tank ring Lock-it 506005-0 / Basic 516005-0 fits all BMW models with inner mounting.

506005-0 Tank ring Lock-it inner mounting

516005-0 Tank ring Basic inner mounting

Item-no.	Description	Info
<b>R 1250 R (2019-)</b>		
6506518 00 01	Side carrier Lock-it	
6526518 01 01	Alurack	
6556518 01 01	Alurack f. Original rack	
6616518 01 01	Easyrack	
6626518 01 01	Easyrack f. Original rack	
6306518 00 01	C-Bow Holder	
5016518 00 01	Engine guard	171
5016518 00 09	Engine guard	171
42226518 00 01	Reinforcement bracket for Off-road (for 5016518)	
42226518 00 05	Reinforcement bracket for Off-road (for 5016518)	
42226518 00 09	Reinforcement bracket for Off-road (for 5016518)	
8006518 00 01	Rear rack enlargement	
42246518 00 01	Kardan protection	
5066518 00 01	Tank ring Lock-it	902
5166518 00 01	Tank ring Basic	702
42116518 00 91	Side stand enlargement	
<b>R 1250 RT (2019-)</b>		
5066523 00 01	Tank ring Lock-it	902
5166523 00 01	Tank ring Basic	702
6556523 01 01	Alurack f. Original rack	
6626523 01 01	Easyrack f. Original rack	
42116523 00 91	Side stand enlargement	

Item-no.	Description	Info
<b>R 1300 GS (2023-)</b>		
6536532 00 01	Side carrier	
6306532 00 01	C-Bow holder	
5166532 00 01	Tank ring Basic	
6526532 01 01	Alurack	
6616532 01 01	Easyrack	
6606532 01 01	Minirack	
8006532 00 01	Rear rack enlargement	203
8016532 00 01	Rear rack enlargement Small	263
6586532 01 01	Rear rack tube type	189
5016532 00 01	Engine guard	262
5016532 00 22	Engine guard	262
5026532 00 01	Taml guard	129
5026532 00 22	Taml guard	129
5036532 00 22	Tank guard for orig. engine guard	94
42126532 00 01	Handle guard	
8106532 00 12	Skid plate	
7006532 00 01	Headlight grille	112
42246532 00 01	Kardan protection	
5056532 00 01	Center stand	
42116532 00 91	Side stand enlargement	
731107	LED auxiliary headlights Nova	133
42136532 00 01	Holder BMW additional lights	
741100 00 01	Tool box	
640003 00 00	Small Sport Star Rack	
<b>K 1300 S (2009-2016)</b>		
650639 00 01	Side carrier	
650639 01 01	Alurack	
650659 01 01	Alurack f. original rack	104
661659 01 01	Easyrack f. original rack	104
630639 00 01	C-Bow Holder	
506659 00 01	Tank ring Lock-it	902
516659 00 01	Tank ring Basic	702

**ATTENTION: You can find the new 2024 models online at [www.hepco-becker.de](http://www.hepco-becker.de)**





Item-no.	Description	Info
<b>K 1300 GT (2009-2011)</b>		
506646 00 01	Tank ring Lock-it	902
516646 00 01	Tank ring Basic	702
<b>K 1300 R (2009-2016)</b>		
650641 00 01	Side carrier	
650641 01 01	Rear rack	
630641 00 01	C-Bow Holder	
502923 00 01	Engine guard	
506642 00 01	Tank ring Lock-it	902
516642 00 01	Tank ring Basic	702
<b>R 18 (2020-)</b>		
6306527 00 01	C-Bow Holder	
6306527 00 02	C-Bow Holder	

<b>NOTICE Tank rings BMW</b>	
Our tank ring Lock-it 506003-6 / Basic 516003-6 fits all BMW models with 6 hole mounting.	
506003-6	Tank ring Lock-it 6 hole
516003-6	Tank ring Basic 6 hole
Our tank ring Lock-it 506002-5 / Basic 516002-5 fits all BMW models with 5 hole mounting.	
506002-5	Tank ring Lock-it 5 hole
516002-5	Tank ring Basic 5 hole
Our tank ring Lock-it 506005-0 / Basic 516005-0 fits all BMW models with inner mounting.	
506005-0	Tank ring Lock-it inner mounting
516005-0	Tank ring Basic inner mounting



**ATTENTION: You can find the new 2024 models online at [www.hepco-becker.de](http://www.hepco-becker.de)**



Item-no.	Description	Info's	Item-no.	Description	Info's	Item-no.	Description	Info's	Item-no.	Description	Info's
<b>Scrambler 400 Sixty2 (2016-)</b>			<b>750 SS / SD (1978-1982)</b>			<b>Monster 797 (2017-)</b>			<b>Scrambler 800 Icon (2023-)</b>		
6527538 01 01	Alurack		650700 00 02	Complete carrier		6307551 00 01	C-Bow holder	27	6307653 00 01	C-Bow holder	161
6617538 01 01	Easyrack		<b>750 Sport (1988-1989)</b>			42117551 00 91	Side stand enlargement		6527653 01 01	Alurack	
6307538 00 01	C-Bow holder		650719 00 01	Complete carrier		5067551 00 01	Tank ring Lock-it	904	6617653 01 01	Easyrack	
5017538 00 01	Engine guard		<b>750 SS (1991-1997)</b>			5167551 00 01	Tank ring Basic	704	6607653 01 01	Minirack	
6607538 01 01	Minirack		650723 00 01	Complete carrier	5: A,B, C,D,E,F	<b>Monster M 800 (2003-2004)</b>			5017653 00 01	Engine guard	
42117538 00 91	Side stand enlargement		650723 01 01	Rear rack	13	506006-5	Tank ring Lock-it		42117653 00 91	Side stand enlargement	
6547538 01 01	Rear rack tube type	106, 141	<b>Monster M 750 (1995-1999)</b>			516006-5	Tank ring Basic		<b>Scrambler 800 Nightshift/Full Throttle (2023-)</b>		
<b>Pantah 500 (1979-1983)</b>			650739 00 01	Side carrier	32, 5: A,B, C,D,E,F	<b>Monster M 800 S2R (2005-2007)</b>			6307654 00 01	C-Bow holder	161
650701 00 01	Complete carrier		650739 01 01	Rear rack		506006-5	Tank ring Lock-it		6527654 01 01	Alurack	
650701 00 02	Complete carrier		506740 00 01	Tank ring Lock-it	904	516006-5	Tank ring Basic		6617654 01 01	Easyrack	
<b>600 SS (1994-1998)</b>			516740 00 01	Tank ring Basic	704	<b>Scrambler 800 (2015-2018)</b>			6607654 01 01	Minirack	
650723 00 01	Complete carrier	5:A,B, C,D,E,F	<b>Hypermotard 796 EVO / SP (2007-2012)</b>			6507530 01 01	Alurack		5017654 00 01	Engine guard	
506723 00 01	Tank ring Lock-it	904	650786 01 01	Minirack	72	6617530 01 01	Easyrack		42117654 00 91	Side stand enlargement	
516723 00 01	Tank ring Basic	704	630713 00 01	C-Bow holder		6307530 00 01	C-Bow holder		<b>Hypermotard 821 / SP (2013-2015)</b>		
650723 01 01	Rear rack	13	<b>Monster 796 (2010-2016)</b>			6607530 01 01	Minirack		6607526 01 01	Minirack	
<b>Monster M 600 (1994-1999)</b>			650718 01 01	Alurack		5017530 00 01	Engine guard	238	6307526 00 01	C-Bow holder	
650739 00 01	Side carrier	32, 5: A,B, C,D,E,F	661718 01 01	Easyrack		5017574 00 01	Engine guard	237	<b>Monster 821 (2014-2017)</b>		
650739 01 01	Rear rack		630714 00 01	C-Bow holder		8007530 00 01	Rear rack enlargement		6607527 01 01	Minirack	
506739 00 01	Tank ring Lock-it	904	506714 00 01	Tank ring Lock-it	153, 915, 4: L1,L2, M1,M2	42117530 00 91	Side stand enlargement		6307527 00 01	C-Bow holder	
516739 00 01	Tank ring Basic	704	516714 00 01	Tank ring Basic	153, 715, 4: L1,L2, M1,M2	6547530 01 01	Rear rack tube type	106,141	5067527 00 01	Tank ring Lock-it	904
<b>Pantah 600 (1980-1984)</b>			<b>NOTICE Tank rings DUCATI</b>			42237530 00 01	Cooler protection bars	167	5167527 00 01	Tank ring Basic	704
650701 00 01	Complete carrier		Our Tank ring Lock-it 506006-5 / Basic 516006-5 fits all DUCATI models with 5 hole mounting.			<b>Scrambler 800 (2019-)</b>			<b>Monster 821 (2018-2020)</b>		
650701 00 02	Complete carrier		506006-5	Tank ring Lock-it 5-hole		6307593 00 01	C-Bow holder		6607565 01 01	Minirack	
<b>Multistrada 620 (2003-2006)</b>			516006-5	Tank ring Basic 5-hole		6527593 01 01	Alurack		6307565 00 01	C-Bow holder	161, 4:1
650784 00 01	Side carrier		Our Tank ring Lock-it 506003-6 / Basic 516003-6 fits all DUCATI models with 6-hole mounting.			6617593 01 01	Easyrack		5067565 00 01	Tank ring Lock-it	904
650784 01 01	Rear rack		506003-6	Tank ring Lock-it 6-hole		6607593 01 01	Minirack		5167565 00 01	Tank ring Basic	704
630784 00 01	C-Bow holder		516003-6	Tank ring Basic 6-hole		6547593 01 01	Rear rack tube type	106,141	42117565 00 91	Side stand enlargement	
<b>Monster 696 (2008-2014)</b>			<b>ATTENTION: You can find the new 2024 models online at <a href="http://www.hepco-becker.de">www.hepco-becker.de</a></b>			8007593 00 01	Rear rack enlargement		<b>848 Evo (2011-2013)</b>		
650718 01 01	Alurack					5017593 00 01	Engine guard	238	506006-5	Tank ring Lock-it	
661718 01 01	Easyrack					5017574 00 01	Engine guard	237	516006-5	Tank ring Basic	
630714 00 01	C-Bow holder					42237593 00 01	Cooler protection bars	167	<b>Streetfighter 848 (2009-2015)</b>		
506718 00 01	Tank ring Lock-it	153, 915, 4: L1,L2, M1,M2				42117593 00 91	Side stand enlargement		670703 00 01	Sportrack	52
516718 00 01	Tank ring Basic	153, 715, 4: L1,L2, M1,M2				<b>900 SS / SD (1978-1982)</b>			<b>900 S 2 (1982-1984)</b>		
						650700 00 02 Complete carrier			650702 00 02 Complete carrier		



**ATTENTION: You can find the new 2024 models online at [www.hepco-becker.de](http://www.hepco-becker.de)**



Item-no.	Description	Info's	Item-no.	Description	Info's	Item-no.	Description	Info's	Item-no.	Description	Info's
<b>900 SS (1991-1998)</b>			<b>DesertX (2022-)</b>			<b>Hypermotard 950 / SP (2019-)</b>			<b>Monster 1100 / S (2009-2010)</b>		
650723 00 01	Complete carrier	5: A,B, C,D,E,F	6517638 00 01-01-40	Xplorer Cutout Set Silver		6607577 01 01	Minirack	172	650718 01 01	Alurack	
650723 01 01	Rear rack	13	6517638 00 01-00-40	Xplorer Cutout Set Black		6307577 00 01	C-Bow holder	172	661718 01 01	Easyrack	
<b>Monster M 900 (1992-1999)</b>			6517638 00 01-00-40	Xplorer Cutout Set Black		42117577 00 91	Side stand enlargement		630714 00 01	C-Bow holder	
650739 00 01	Side carrier	32, 5: A,B, C,D,E,F	6517638 00 01	Cutout carrier	4:C3,C4	5067577 00 01	Tank ring Lock-it	902	506713 00 01	Tank ring Lock-it	153, 915, 4: L1,L2, M1,M2
650739 01 01	Rear rack		6307638 00 01	C-Bow holder		5167577 00 01	Tank ring Basic	702	516713 00 01	Tank ring Basic	153, 715, 4: L1,L2, M1,M2
506738 00 01	Tank ring Lock-it	904	6527638 01 01	Alurack		<b>Multistrada 950 (2017-) / S</b>			<b>Monster 1100 Evo (2011-2013)</b>		
516738 00 01	Tank ring Basic	704	6617638 01 01	Easyrack		6307552 00 01	C-Bow holder		6507502 01 01	Alurack	
<b>Monster 900i.e. (2000-2003)</b>			6607638 01 01	Minirack		6617552 01 01	Easyrack		6617502 01 01	Easyrack	
650766 00 01	Side carrier		6707638 00 01	Sportrack	52,169	5067552 00 01	Tank ring Lock-it	902	6307502 00 01	C-Bow holder	
650766 01 01	Rear rack		8007638 00 01	Rear rack enlargement		5167552 00 01	Tank ring Basic	702	506750 00 01	Tank ring Lock-it	153, 915, 4: L1,L2, M1,M2
506766 00 01	Tank ring Lock-it	904	5027638 00 01	Tank guard	206	5027552 00 22	Tank guard		516750 00 01	Tank ring Basic	153, 715, 4: L1,L2, M1,M2
516766 00 01	Tank ring Basic	704	5027638 00 03	Tank guard	206	5027552 00 01	Tank guard		<b>Scrambler 1100 / Special / Sport (2018-2020)</b>		
<b>907 I. E. (1991-1994)</b>			8107638 00 01	Skid plate	210	42117552 00 91	Side stand enlargement		6527566 01 01	Alurack	
650725 00 01	Complete carrier	5: A,B, C,D,E,F	8107638 00 12	Skid plate	210	6537552 00 01	Side carrier		6617566 01 01	Easyrack	
506725 00 01	Tank ring Lock-it	904	42237638 00 01	Additional guard, one-sided left	65	42127552 00 01	Handle guard		6307566 00 01	C-Bow holder	
516725 00 01	Tank ring Basic	704	42237638 00 03	Additional guard, one-sided left	65	<b>Multistrada 1000 (2003-2006)</b>			5017566 00 01	Engine guard	
<b>Monster 937 / Monster + (2021-)</b>			6417638 00 01	Crash bar bag set V1		650784 00 01	Side carrier		42117566 00 91	Side stand enlargement	
6307615 00 01	C-Bow holder		7007638 00 01	Headlight grille	112	650784 01 01	Rear rack		7007566 00 01	Headlight grilles	112
5067615 00 01	Tank ring Lock-it	904	42127638 00 03	Handle guard	201	630784 00 01	C-Bow holder		8007566 00 01	Rear rack enlargement	
5167615 00 01	Tank ring Basic	704	42127638 00 01	Handle guard	201	<b>GT 1000 (2007-2010)</b>			6547566 01 01	Rear rack tube type	141
6707615 00 01	Sportrack	52,169	731107	LED auxiliary headlights Nova	133	650795 00 01	Side carrier		<b>Streetfighter 1098/S (2009-2012)</b>		
42117615 00 91	Side stand enlargement		42117638 00 91	Side stand enlargement		650795 01 01	Rear rack		670703 00 01	Sportrack	52
<b>NOTICE Tank rings DUCATI</b>			<b>Hypermotard 939 / SP (2016-2018)</b>			<b>Monster M 1000 i.E. (2003-2005)</b>			<b>Streetfighter V4 / S (2020-)</b>		
Our Tank ring Lock-it 506006-5 / Basic 516006-5 fits all DUCATI models with 5 hole mounting.			6607540 01 01	Minirack		506006-5	Tank ring Lock-it		<b>Panigale V4 / S / R (2018-)</b>		
506006-5	Tank ring Lock-it 5-hole		6307540 00 01	C-Bow holder		516006-5	Tank ring Basic		6307623 00 01 C-Bow holder		
516006-5	Tank ring Basic 5-hole		42117540 00 91	Side stand enlargement		<b>Multistrada 1100 (2007-2009)</b>					
Our Tank ring Lock-it 506003-6 / Basic 516003-6 fits all DUCATI models with 6-hole mounting.			650757 00 01	Complete carrier		650784 00 01	Side carrier				
506003-6	Tank ring Lock-it 6-hole		506757 00 01	Tank ring Lock-it	904	650784 01 01	Rear rack				
516003-6	Tank ring Basic 6-hole		516757 00 01	Tank ring Basic	704	630784 00 01	C-Bow holder				
			650757 01 01	Rear rack		<b>Hypermotard 1100 EVO / SP (2007-2012)</b>					
						650786 01 01	Minirack	72			
						630713 00 01	C-Bow holder				



Info reference see p. 271

The last digit of the item-no. refers to the colours: 01= black 02= chrome 03= white 04= red 05= anthracite 06= orange 08= yellow 09= silver 10= blue metallic 12= Alu brushed 22= Stainless steel 91= silver/black



**ATTENTION: You can find the new 2024 models online at [www.hepco-becker.de](http://www.hepco-becker.de)**

Item-no.	Description	Info's
<b>Multistrada V4 / S / S Sport / Rally (2021-)</b>		
6517614 00 22 00-40	Xplorer Cutout Set	
6517614 00 22 01-40	Xplorer Cutout Set Black	
6517614 00 22	Cutout carrier	
6307614 00 01	C-Bow holder	
5017614 00 01	Engine Guard	
5017614 00 04	Engine Guard	
640100 00 01	Crash bar bag set V1	
42127614 00 01	Handle guard	121
42127614 00 04	Handle guard	121
5067614 00 01	Tank ring Lock-it	902
5167614 00 01	Tank ring Basic	702
6557614 01 01	Alurack f. original rack	
6627614 01 01	Easyrack f. original rack	
8007614 00 01	Rear rack enlargement	
42117614 00 91	Side stand enlargement	
<b>1198 R (2009-2011)</b>		
506006-5	Tank ring Lock-it	
516006-5	Tank ring Basic	
<b>Monster 1200 / S (2013-2016)</b>		
6607525 01 01	Minirack	
6307525 00 01	C-Bow holder	
5067525 00 01	Tank ring Lock-it	904
5167525 00 01	Tank ring Basic	704
<b>Monster 1200 S (2017-)</b>		
6307562 00 01	C-Bow holder	4:1
6607562 01 01	Minirack	
5067562 00 01	Tank ring Lock-it	904
5167562 00 01	Tank ring Basic	704
42117562 00 91	Side stand enlargement	
<b>Monster 1200 R (2016-)</b>		
6607546 01 01	Minirack	
6307546 00 01	C-Bow holder	4:1
5067546 00 01	Tank ring Lock-it	904
5167546 00 01	Tank ring Basic	704
42117546 00 91	Side stand enlargement	

Item-no.	Description	Info's
<b>Diavel (2011-2018)</b>		
6507503 01 01	Alurack	
6617503 01 01	Easyrack	
6307503 00 01	C-Bow holder	
<b>X Diavel / S (2016-) / 1260 ccm</b>		
6307539 00 01	C-Bow holder	4:1
<b>Multistrada 1200 / S (2010-2014)</b>		
650727 01 01	Alurack	
661727 01 01	Easyrack	
630727 00 01	C-Bow holder	
506727 00 01	Tank ring Lock-it	904
516727 00 01	Tank ring Basic	704
42117527 00 91	Side stand enlargement	
<b>Multistrada 1200 / S (2015-2017)</b>		
6507531 01 01	Alurack	
6617531 01 01	Easyrack	
6307531 00 01	C-Bow holder	
506753 00 01	Tank ring Lock-it	902
516753 00 01	Tank ring Basic	702
42117531 00 91	Side stand enlargement	
42127531 00 01	Handle guard	
<b>Multistrada 1200 Enduro (2016-)</b>		
6527560 01 01	Alurack	
6617560 01 01	Easyrack	
6307560 00 01	C-Bow holder	
5067560 00 01	Tank ring Lock-it	902
5167560 00 01	Tank ring Basic	702
5027560 00 22	Tank guard	
5027560 00 01	Tank guard	
42117560 00 91	Side stand enlargement	
42127560 00 01	Handle guard	
<b>Diavel 1260 / S (2019-)</b>		
6307578 00 01	C-Bow holder	
5067578 00 01	Tank ring Lock-it	
5167578 00 01	Tank ring Basic	

Item-no.	Description	Info's
<b>Multistrada 1260 / S (2018-)</b>		
6537567 00 01	Side carrier	0
6527567 01 01	Alurack	
6617567 01 01	Easyrack	
6307567 00 01	C-Bow holder	
5067567 00 01	Tank ring Lock-it	902
5167567 00 01	Tank ring Basic	702
42117567 00 91	Side stand enlargement	
42127567 00 01	Handle guard	239
<b>Multistrada 1260 Enduro (2019-)</b>		
6537579 00 01	Side carrier	0
6527579 01 01	Alurack	
6617579 01 01	Easyrack	
6307579 00 01	C-Bow holder	
5027579 00 01	Tank guard	
5027579 00 22	Tank guard	
5067579 00 01	Tank ring Lock-it	902
5167579 00 01	Tank ring Basic	702
42117579 00 91	Side stand enlargement	
42127579 00 01	Handle guard	

<b>NOTICE Tank rings DUCATI</b>	
Our Tank ring Lock-it 506006-5 / Basic 516006-5 fits all DUCATI models with 5 hole mounting.	
506006-5	Tank ring Lock-it 5-hole
516006-5	Tank ring Basic 5-hole
Our Tank ring Lock-it 506003-6 / Basic 516003-6 fits all DUCATI models with 6-hole mounting.	
506003-6	Tank ring Lock-it 6-hole
516003-6	Tank ring Basic 6-hole

**ATTENTION: You can find the new 2024 models online at [www.hepco-becker.de](http://www.hepco-becker.de)**



# HARLEY-DAVIDSON

Item-no.	Description	Info's
<b>Sportster Super Low (-2020)</b>		
626718 00 01	Rugged Cutout	4:R2
630718 00 02	C-Bow holder	114
4220718 00 01	Canister cutout set	
<b>Sportster 883 Low (-2020)</b>		
626718 00 01	Rugged Cutout	4:R2
630718 00 02	C-Bow holder	114
4220718 00 01	Canister cutout set	
<b>Sportster 883 Roadster (-2020)</b>		
626718 00 01	Rugged Cutout	4:R2
630718 00 02	C-Bow holder	114
4220718 00 01	Canister cutout set	
<b>Sportster 883 Iron (-2020)</b>		
626718 00 01	Rugged Cutout	4:R2
630718 00 02	C-Bow holder	114
4220718 00 01	Canister cutout set	
<b>Sportster 883 Custom (-2020)</b>		
626718 00 01	Rugged Cutout	4:R2
630718 00 02	C-Bow holder	114
4220718 00 01	Canister cutout set	
<b>Sportster 1200 Custom (-2020)</b>		
626718 00 01	Rugged Cutout	4:R2
630718 00 02	C-Bow holder	114
4220718 00 01	Canister cutout set	
<b>Sportster Forty-Eight (-2020)</b>		
626718 00 01	Rugged Cutout	4:R2
630718 00 02	C-Bow holder	114
4220718 00 01	Canister cutout set	
<b>Sportster Seventy-Two (-2020)</b>		
626718 00 01	Rugged Cutout	4:R2
630718 00 02	C-Bow holder	114
4220718 00 01	Canister cutout set	
<b>XR 1200</b>		
630724 00 01	C-Bow holder	114, 4:l

Item-no.	Description	Info's
<b>Dyna Street Bob</b>		
626726 00 01	Rugged Cutout	4:R2
630722 00 02	C-Bow holder	161
<b>Dyna Low Rider</b>		
626726 00 01	Rugged Cutout	4:R2
630722 00 02	C-Bow holder	161
<b>Dyna Wide Glide</b>		
626726 00 01	Rugged Cutout	4:R2
630719 00 02	C-Bow holder	161
<b>Dyna Fat Bob</b>		
626726 00 01	Rugged Cutout	4:R2
630716 00 02	C-Bow holder	
<b>Dyna Super Glide</b>		
626726 00 01	Rugged Cutout	4:R2
630722 00 02	C-Bow holder	161
<b>Softail Breakout</b>		
630730 00 01	C-Bow holder	27
630730 00 02	C-Bow holder	27
<b>Softail Cross Bones</b>		
630717 00 02	C-Bow holder	
<b>Softail Custom</b>		
630717 00 02	C-Bow holder	
<b>Softail Low Rider / S (2018-)</b>		
630733 00 01	C-Bow holder	
630733 00 02	C-Bow holder	
<b>Softail Slim (2018-)</b>		
630728 00 01	C-Bow holder	
630728 00 02	C-Bow holder	
<b>Softail Standard (2020-)</b>		
6307608 00 01	C-Bow holder	
6307608 00 02	C-Bow holder	
<b>Softail Street Bob (2018-)</b>		
630732 00 01	C-Bow holder	
630732 00 02	C-Bow holder	

Item-no.	Description	Info's
<b>Pan America 1250 / Special (2021-)</b>		
6517600 00 01-00-40	Xplorer Cutout Set	124
6517600 00 01-01-40	Xplorer Cutout Set Black	124
6517600 00 01	Cutout carrier	
6527600 01 01	Alurack	68
6617600 01 01	Easyrack	68
6607600 01 01	Minirack	
8007600 00 01	Rear rack enlargement	
5067600 00 01	Tank ring Lock-it	
5167600 00 01	Tank ring Basic	
5017600 00 01	Engine guard	
8107600 00 01	Skid plate	
42257600 00 01	Heat shield	
42127600 00 01	Handle guard	

**NOTICE Rugged Cutout**  
 The Rugged Cutout holder fits the special leather bags Rugged Cutout only.  
 620350 Rugged Cutout

**ATTENTION: You can find the new 2024 models online at [www.hepco-becker.de](http://www.hepco-becker.de)**



Info reference see p. 271

The last digit of the item-no. refers to the colours: 01= black 02= chrome 03= white 04= red 05= anthracite 06= orange 08= yellow 09= silver 10= blue metallic 12= Alu brushed 22= Stainless steel 91= silver/black

Item-no.	Description	Infos	Item-no.	Description	Infos	Item-no.	Description	Infos	Item-no.	Description	Infos
<b>Dax ST 50</b>			<b>CB 125 F (2015-2020)</b>			<b>MSX 125 Grom (2021-)</b>			<b>VT 125 C2 Shadow (1999-2000)</b>		
650181 01 02	Rear rack	13	650139 01 01	Alurack		6609536 01 01	Minirack		650910 00 02	Side carrier	
<b>Wave 110 i (2012-2016)</b>			661139 01 01	Easyrack		<b>NSR 125 (1994-2001)</b>			650910 01 02	Rear rack	
650975 01 01	Minirack	72,13	501139 00 01	Engine Guard		650900 01 01	Rear rack		625910 00 02	Leather bag holder tube type	
650975 01 01-089 bl	SET with Journey TC 40	13	503139 00 01	Front Guard		<b>Pantheon 125 (2003)</b>			501120 00 02	Engine Guard	
650975 01 01-089 si	SET Journey TC 40 silver	13	660139 01 01	Minirack	100	650905 01 01	Rear rack		611114 00 02	Sissybar with rack	59
650975 01 01-206	SET with Journey TC 30	13	<b>CB 125 F (2021-)</b>			<b>Pantheon 125 (2004-2007)</b>			600114 00 02	Sissybar without rack	59
<b>PCX 125 (2012-)</b>			6529527 01 01	Alurack		650941 01 01	Rear rack		611115 00 02	Solorack with pad	59
650974 01 01	Adapter set for mounting of universal top cases	13	6619527 01 01	Easyrack		<b>Varadero 125 (2001-2006)</b>			600115 00 02	Solorack without pad	59
<b>Monkey 125 (2019-)</b>			5019527 00 01	Engine Guard		650921 00 01	Side carrier	0	400910 00 02	Twinlight Set	
6549523 01 01	Rear rack tube type	100	5039527 00 01	Front Guard		650921 01 01	Rear rack	9	<b>XLR 125 (1998-1999)</b>		
6549523 01 02	Rear rack tube type	100	6609527 01 01	Minirack		501124 00 01	Engine Guard	8	650903 01 01	Rear rack	
6549523 01 03	Rear rack tube type	100	<b>CB 125 R (2018-)</b>			800917 00 09	Rear rack enlargement		<b>XR 125 L (2002-2008)</b>		
5069523 00 01	Tank ring Lock-it	916, 4:L1,M1	6609507 01 01	Minirack	100	<b>Varadero 125 (2007-2012)</b>			501932 00 01	Engine Guard	
5169523 00 01	Tank ring Basic	716, 4:L1,M1	6309507 00 01	C-Bow holder		650950 00 01	Side carrier	0	<b>CM 185 / CM 200 T (1978-1984)</b>		
7009523 00 01	Headlight grilles	112	5019507 00 01	Engine Guard (-2020)		650950 01 01	Rear rack	9	650136 00 02	Complete carrier	
<b>ST 125 Dax (2023-)</b>			5019526 00 01	Engine Guard (2021-)		501950 00 01	Engine Guard		<b>CB 250 N (1978-1981)</b>		
6589542 01 02	Rear rack tube type	100	5039507 00 01	Front Guard		800917 00 09	Rear rack enlargement		650100 00 02	Complete carrier	
4109542 00 02	Fender Guard		6709507 00 01	Sportrack	52	<b>NOTICE Tank rings HONDA</b>					
7009542 00 01	Headlight grilles	112	5069507 00 01	Tank ring Lock-it	911	Our tank ring Lock-it 506007-7 / Basic 516007-7 fits all Honda models with a 7 hole fixing and M6 screws.					
<b>CA 125 Rebel (1995-2001)</b>			5169507 00 01	Tank ring Basic	711	506007-7	Tank ring Lock-it 7-hole		<b>CB 250 N (1981-1986)</b>		
650105 00 02	Side carrier		42119507 00 91	Side stand enlargement		516007-7	Tank ring Basic 7-hole		650102 00 02	Complete carrier	
650105 01 02	Rear rack	22	<b>CBR 125 R (2007-2011)</b>			Our tank ring Lock-it 506013-5 / Basic 516013-5 fits all Honda models with 5 hole mounting.					
625105 00 02	Leather bag holder tube type		650936 01 01	Rear rack		506013-5	Tank ring Lock-it 5-hole		650102 01 02	Rear rack	22
501112 00 02	Engine Guard		501936 00 01	Engine Guard		516013-5	Tank ring Basic 5-hole		<b>CB Two-Fifty (1996-1999)</b>		
611106 00 02	Sissybar with rack	59	504936 00 01	Rear Guard		Our tank ring Lock-it 506018-7 / Basic 516018-7 fits all Honda models with a 7 hole fixing and M4 screws.					
600106 00 02	Sissybar without rack	59	<b>CBR 125 R (2011-2016)</b>			506018-7	Tank ring Lock-it 7-hole		650124 00 01	Complete carrier	
400105 00 02	Twinlight Set		650964 01 01	Minirack	73	516018-7	Tank ring Basic 7-hole		650124 01 01	Rear rack	22
<b>CBF 125 (2008-2015)</b>			<b>CG 125 (1998-)</b>			<b>CRF 250 L (2012-2021)</b>					
650956 01 01	Alurack		650904 01 01	Rear rack		650976 01 01	Minirack	72	650976 01 01-089 bl	Set with Journey TC 40 black	13
661956 01 01	Easyrack		<b>CM 125 C (1982-1986)</b>			650976 01 01-089 si	Set with Journey TC 40 silver	13	650976 01 01-206	Set with Journey TC 30	13
501956 00 01	Engine Guard		501105 00 02	Engine Guard		501976 00 01 Engine Guard					
503956 00 01	Front Guard		<b>MSX 125 (2013-2016)</b>								
504956 00 01	Rear Guard		660981 01 01	Minirack	100						
			<b>MSX 125 / Grom (2017-2020)</b>								
			6609504 01 01	Minirack	100						

**ATTENTION: You can find the new 2024 models online at [www.hepco-becker.de](http://www.hepco-becker.de)**



Item-no.	Description	Infos	Item-no.	Description	Infos	Item-no.	Description	Infos	Item-no.	Description	Infos
<b>CRF 250 Rally (2017-2021)</b>			<b>CMX 250 Rebel (1996-2001)</b>			<b>CRF 300 Rally (2021-)</b>			<b>CB 400 N (1981-1986)</b>		
6609511 01 01	Minirack		650105 00 02	Side carrier		6509535 01 01-089 bl	Set with Journey TC40	196	650102 00 02	Complete carrier	
6609511 01 01-089 bl	Set with Journey TC 40 black	13	650105 01 02	Rear rack	22	6509535 01 01-089 si	Set with Journey TC40	196	650102 01 02	Rear rack	22
6609511 01 01-089 si	Set with Journey TC 40 silver cover	13	625105 00 02	Leather bag holder tube type		6509535 01 01-206	Set with Journey TC30	196	<b>CM 400 T (1980-1984)</b>		
6609511 01 01-206	Set with Journey TC 30	13	501114 00 02	Engine Guard		6609535 01 01	Minirack		650106 00 02	Complete carrier	
<b>CM 250 C / T (1982-1984)</b>			<b>Foresight 250 (1998-2001)</b>			5069535 00 01	Tank ring Lock-it	916, 4: M, L1, L2	650185 00 01	Complete carrier	5: A,B, C,D,E,F
650137 00 02	Complete carrier		650905 01 01	Rear rack		5169535 00 01	Tank ring Basic	716, 4: M, L1, L2	650185 01 01	Rear rack	22
<b>CBR 250 R (2011-2015)</b>			<b>NX 250 (1988-1996)</b>			7009535 00 01	Headlight grille	112	<b>CB 450 S (1986-1989)</b>		
650966 01 01	Minirack	73	650178 00 01	Side carrier	0	6309535 00 01	C-Bow holder	200	650167 00 01	Complete carrier	5: A,B, C,D,E,F
630966 00 01	C-Bow holder		650178 01 01	Rear rack	9	8109535 00 01	Skid plate		650167 01 01	Rear rack tube type	
506966 00 01	Tank ring Lock-it	905	<b>CB 300 R (2018-)</b>			<b>CRF 300 L (2021-)</b>			<b>CRF 450 L (2018-2021)</b>		
516966 00 01	Tank ring Basic	705	6609508 01 01	Minirack	100	6609534 01 01-089 bl	Set with Journey TC40	196	5019516 00 01	Engine Guard	
<b>CN 250 Helix Roller (1991-1996)</b>			6309508 00 01	C-Bow holder	4:1	6509534 01 01-089 si	Set with Journey TC40	196	6609516 01 01-089 bl	Journey TC40 Set, black	
650157 01 01	Rear rack	34	5019508 00 01	Engine Guard (2018-2021)		6509534 01 01-206	Set with Journey TC30	196	6609516 01 01-089 si	Journey TC40 Set, silver cover	
			5039508 00 01	Front Guard		6309534 00 01	C-Bow holder	200	6609516 01 01-206	Journey TC30 Set	
			6709508 00 01	Sportrack	52	<b>ADV 350 (2022-)</b>					
			5069508 00 01	Tank ring Lock-it	911	6529538 01 01	Alurack				
			5169508 00 01	Tank ring Basic	711	6619538 01 01	Easyrack				
			42119508 00 91	Side stand enlargement		6609538 01 01	Minirack				
			<b>CBR 300 R (2014-2017)</b>			6109538 00 01	Topcase railing	197			
			660991 01 01	Minirack	73	42129538 00 01	Hand guard				
			670991 00 01	Sportrack	52	42119538 00 91	Side stand enlargement				
			630991 00 01	C-Bow holder		42239538 00 01	Fairing Guard				
			4211991 00 91	Side stand enlargement		<b>CB 350 F / 400 F (1973-1974)</b>					
						650141 00 02	Complete carrier	5: A,B, C,D,E,F			
						<b>Forza 350 (2021-)</b>					
						6109540 00 01	Topcase Railing	197			
						<b>CB 400 N (1978-1980)</b>					
						650100 00 02	Complete carrier				

## NOTICE Tank rings HONDA

Our tank ring Lock-it 506007-7 / Basic 516007-7 fits all Honda models with a 7 hole fixing and M6 screws.

506007-7 Tank ring Lock-it 7-hole

516007-7 Tank ring Basic 7-hole

Our tank ring Lock-it 506013-5 / Basic 516013-5 fits all Honda models with 5 hole mounting.

506013-5 Tank ring Lock-it 5-hole

516013-5 Tank ring Basic 5-hole

Our tank ring Lock-it 506018-7 / Basic 516018-7 fits all Honda models with a 7 hole fixing and M4 screws.

506018-7 Tank ring Lock-it 7-hole

516018-7 Tank ring Basic 7-hole



**ATTENTION: You can find the new 2024 models online at [www.hepco-becker.de](http://www.hepco-becker.de)**



Info reference see p. 271

The last digit of the item-no. refers to the colours: 01= black 02= chrome 03= white 04= red 05= anthracite 06= orange 08= yellow 09= silver 10= blue metallic 12= Alu brushed 22= Stainless steel 91= silver/black

Item-no.	Description	Infos
<b>CMX 500 Rebel (2017-)</b>		
630998 00 01	C-Bow holder	123
613998 00 01	Solorack without Backrest	
612998 00 01	Solorack with Backrest	
501998 00 01	Engine Guard	
640100 00 01	Crash bar bag set V1	
4216998 00 01	Driver's backrest	
600998 00 01	Sissybar without rack	
611998 00 01	Sissybar with rack	
658998 01 01	Rear rack tube type	189
652998 01 01	Alurack	
661998 01 01	Easyrack	
660998 01 01	Minirack	10
700998 00 01	Headlight grille (-2019)	112
701998 00 01	Headlight grilles (2020-)	112,240
506998 00 01	Tank ring Lock-it	
516998 00 01	Tank ring Basic	
503998 00 01	Front Guard	176
400998 00 01	Twinlight Set (2020-)	204
<b>CX 500 A / B / SC (1978-1985)</b>		
650109 00 02	Complete carrier	
650109 01 02	Rear rack	22

Item-no.	Description	Infos
<b>CX 500 Custom (1979-1984)</b>		
650110 00 02	Complete carrier	
650110 01 02	Rear rack	22
<b>CX 500 Euro (1982-1985)</b>		
650112 00 01	Complete carrier	6
650112 01 01	Rear rack	22
<b>CX 500 Turbo (1982-1985)</b>		
650112 00 01	Complete carrier	6
650112 01 01	Rear rack	22
<b>GL 500 (1982-1984)</b>		
650111 00 02	Complete carrier	21, 2: A1,A2,F
<b>FT 500 (1982-1985)</b>		
650108 00 01	Complete carrier	
650108 01 01	Rear rack	22
<b>VF 500 F / F 2 (1984-1987)</b>		
650160 00 01	Complete carrier	
650160 01 01	Rear rack	22
<b>GB 500 Clubman (1992)</b>		
650190 00 02	Complete carrier	
650190 01 02	Rear rack	
<b>VT 500 Custom (1983-1988)</b>		
650131 00 02	Complete carrier	
650131 01 02	Rear rack	13,22
<b>VT 500 E (1983-1988)</b>		
650142 00 02	Complete carrier	5: A,B, C,D,E,F
650142 01 01	Rear rack	22
<b>XBR 500 S (1985-1990)</b>		
650164 00 02	Complete carrier	
650164 01 01	Rear rack	13,22
<b>XL 500 S (1979-1981)</b>		
650143 00 01	Complete carrier	0

Item-no.	Description	Infos
<b>CB 500 Four / CB 500 F (1971-1978)</b>		
6509506 00 02	Complete carrier	
6549506 01 02	Rear rack tube type	
5019506 00 02	Engine Guard	
42199506 00 02	Pillion handle	96
<b>CB 500 / S (1993-1997)</b>		
650103 00 01	Complete carrier	
650103 01 01	Rear rack	22
501108 00 01	Engine Guard	
503103 00 01	Front Guard	
504103 00 01	Rear Guard	
506108 00 01	Tank ring Lock-it	905
516108 00 01	Tank ring Basic	705
<b>CB 500 F (2013-2015)</b>		
650977 00 05	Side carrier Lock-it	85, 90,99
650977 01 05	Alurack	85,90
661977 01 05	Easyrack	85, 90,118
630977 00 05	C-Bow holder	
501977 00 05	Engine Guard	
503977 00 05	Front Guard	
504977 00 05	Rear Guard	98
670977 00 01	Sportrack	52
505977 00 01	Center stand	
4219977 00 05	Pillion handle	96
4211977 00 91	Side stand enlargement	

Item-no.	Description	Infos
<b>CB 500 F (2016-2018)</b>		
652996 01 05	Alurack	
661996 01 05	Easyrack	
660996 01 05	Minirack	
630996 00 05	C-Bow holder	
501996 00 05	Engine Guard	
503996 00 05	Front Guard	
670996 00 01	Sportrack	52
505996 00 01	Center stand	
506996 00 01	Tank ring Lock-it	911
516996 00 01	Tank ring Basic	711
4211996 00 91	Side stand enlargement	
<b>CB 500 F (2019-)</b>		
6529515 01 05	Alurack	
6619515 01 05	Easyrack	
6609515 01 05	Minirack	
6309515 00 05	C-Bow holder	
5019515 00 05	Engine Guard	
5039515 00 05	Front Guard	
5049515 00 05	Rear Guard	
6709515 00 01	Sportrack	52
5059515 00 01	Center stand	
5069515 00 01	Tank ring Lock-it	911
5169515 00 01	Tank ring Basic	711
42119515 00 91	Side stand enlargement	

## NOTICE Tank rings HONDA

Our tank ring Lock-it 506007-7 / Basic 516007-7 fits all Honda models with a 7 hole fixing and M6 screws.

506007-7 Tank ring Lock-it 7-hole

516007-7 Tank ring Basic 7-hole

Our tank ring Lock-it 506013-5 / Basic 516013-5 fits all Honda models with 5 hole mounting.

506013-5 Tank ring Lock-it 5-hole

516013-5 Tank ring Basic 5-hole

Our tank ring Lock-it 506018-7 / Basic 516018-7 fits all Honda models with a 7 hole fixing and M4 screws.

506018-7 Tank ring Lock-it 7-hole

516018-7 Tank ring Basic 7-hole

**ATTENTION: You can find the new 2024 models online at [www.hepco-becker.de](http://www.hepco-becker.de)**





Item-no.	Description	Infos	Item-no.	Description	Infos	Item-no.	Description	Infos	Item-no.	Description	Infos
<b>CB 500 X (2013-2016)</b>			<b>CB 500 X (2019-)</b>			<b>CL 500 (2023-)</b>			<b>CBR 500 R (2016-2018)</b>		
650978 00 05	Side carrier Lock-it	85 90,99	6509514 00 05	Side carrier Lock-it		6539543 00 01	Side carrier, one-sided left	36	652995 01 05	Alurack	
650978 01 05	Alurack	90	6529514 01 05	Alurack		6319543 00 01L	C-Bow holder, one-sided left		661995 01 05	Easyrack	
661978 01 05	Easyrack	90 118	6619514 01 05	Easyrack		42199543 00 01	Pillion handle		660995 01 05	Minirack	
630978 00 05	C-Bow holder		6309514 00 05	C-Bow holder		6589543 01 01	Rear rack tube type	189	630995 00 05	C-Bow holder	
501978 00 05	Engine Guard		5019514 00 05	Engine Guard		6529543 01 01	Alurack		670995 00 01	Sportrack	52
731107	LED auxiliary headlights Nova	133	640100 00 01	Crash bar bag set V1		6619543 01 01	Easyrack		505995 00 01	Center stand	
502978 00 05	Tank Guard		5029514 00 05	Tank Guard		6609543 01 01	Minirack		4211995 00 91	Side stand enlargement	
640100 00 01	Crash bar bag set V1		5049514 00 05	Rear Guard		5019543 00 01	Engine guard		506995 00 01	Tank ring Lock-it	911
503978 00 05	Front Guard		42199514 00 05	Pillion handle	96	5169543 00 01	Tank ring Basic	711	516995 00 01	Tank ring Basic	711
504978 00 05	Rear Guard	98	42119514 00 91	Side stand enlargement		5069543 00 01	Tank ring Lock-it	911	<b>CBR 500 R (2019-)</b>		
505978 00 01	Center stand		731107	LED auxiliary headlights Nova	133	7009543 00 01	Headlight grille	112	6529517 01 05	Alurack	
4219978 00 05	Pillion handle	96	5069514 00 01	Tank ring Lock-it	916	42119543 00 91	Side stand enlargement		6619517 01 05	Easyrack	
4211978 00 91	Side stand enlargement		5169514 00 01	Tank ring Basic	716	<b>CBF 500 (2004-2007)</b>			6609517 01 05	Minirack	
<b>CB 500 X (2017-2018)</b>			<b>NOTICE Tank rings HONDA</b>			<b>CBF 500 (2004-2007)</b>			6309517 00 05	C-Bow holder	
6509503 00 05	Side carrier Lock-it	85 90,99	Our tank ring Lock-it 506007-7 / Basic 516007-7 fits all Honda models with a 7 hole fixing and M6 screws.			650945 00 01	Side carrier Lock-it		6709517 00 01	Sportrack	52
6529503 01 05	Alurack	90	506007-7	Tank ring Lock-it 7-hole		650945 01 01	Alurack		5069517 00 01	Tank ring Lock-it	911
6619503 01 05	Easyrack	90,118	516007-7	Tank ring Basic 7-hole		661945 01 01	Easyrack		5169517 00 01	Tank ring Basic	711
6309503 00 05	C-Bow holder		Our tank ring Lock-it 506013-5 / Basic 516013-5 fits all Honda models with 5 hole mounting.			630947 00 01	C-Bow holder		42119517 00 91	Side stand enlargement	
5019503 00 05	Engine Guard		506013-5	Tank ring Lock-it 5-hole		501937 00 01	Engine Guard		<b>CB 550 K3 (1977-1978)</b>		
731107	LED auxiliary headlights Nova	133	516013-5	Tank ring Basic 5-hole		503937 00 01	Front Guard		650149 00 02	Complete carrier	
5029503 00 05	Tank Guard		Our tank ring Lock-it 506018-7 / Basic 516018-7 fits all Honda models with a 7 hole fixing and M4 screws.			504937 00 01	Rear Guard		<b>CBX 550 F / F2 (1982-1985)</b>		
640100 00 01	Crash bar bag set V1		506018-7	Tank ring Lock-it 7-hole		505937 00 01	Center stand		650113 00 01	Complete carrier	
5039503 00 05	Front Guard		516018-7	Tank ring Basic 7-hole		506937 00 01	Tank ring Lock-it	905	650113 01 01	Rear rack	22
5049503 00 05	Rear Guard	98	<b>ATTENTION: You can find the new 2024 models online at <a href="http://www.hepco-becker.de">www.hepco-becker.de</a></b>			516937 00 01	Tank ring Basic	705	<b>Roller Silver Wing (2003-2007)</b>		
5059503 00 01	Center stand					<b>CBR 500 R (2013-2015)</b>			650922 01 01	Rear rack	
42199503 00 05	Pillion handle	96				650980 00 05	Side carrier Lock-it	85 90,99	<b>XL 600 LM (1986-1988)</b>		
42119503 00 91	Side stand enlargement					650980 01 05	Alurack		650168 00 01	Side carrier	0
5069503 00 01	Tank ring Lock-it	911 4:L1,M1				661980 01 05	Easyrack	118	<b>XL 600 R (1983-1987)</b>		
5169503 00 01	Tank ring Basic	711 4:L1,M1				630980 00 05	C-Bow holder		650144 00 01	Side carrier	0
						504980 00 05	Rear Guard	98	<b>XL 600 RM (1986-1988)</b>		
						670980 00 01	Sportrack	52	650129 00 01	Side carrier	0
						505980 00 01	Center stand		<b>XL 600 V Transalp (1987-2000)</b>		
						4211980 00 91	Side stand enlargement		650171 00 01	Side carrier	0
									650171 01 01	Rear rack	8,9
									502102 00 01	Engine Guard	
									800171 00 09	Rear rack enlargement	8



Item-no.	Description	Infos	Item-no.	Description	Infos	Item-no.	Description	Infos	Item-no.	Description	Infos
<b>CBX 600 / 650 E (1983-1987)</b>			<b>CB 600 F Hornet (2011-2015)</b>			<b>CBF 600 S/N (2008-2013)</b>			<b>CBR 600 RR (2003-)</b>		
650114 00 01	Complete carrier		650965 01 01	Alurack		650953 00 01	Side carrier Lock-it		506007-7	Tank ring Lock-it	
<b>VT 600 C (1988-2000)</b>			661965 01 01	Easyrack		650953 01 01	Alurack		516007-7	Tank ring Basic	
650176 00 02	Complete carrier	8	630965 00 01	C-Bow holder		661953 01 01	Easyrack		<b>CBR 600 F (2011-2013)</b>		
650176 01 02	Rear rack	22	506965 00 01	Tank ring Lock-it	905	630947 00 01	C-Bow holder		650967 01 01	Alurack	
625176 00 02	Leather bag holder tube type	3:P,S	516965 00 01	Tank ring Basic	705	506953 00 01	Tank ring Lock-it	905	661967 01 01	Easyrack	
501102 00 02	Engine Guard		501965 00 01	Engine Guard		516953 00 01	Tank ring Basic	705	630967 00 01	C-Bow holder	
611101 00 02	Sissybar with rack	8,59	<b>CBF 600 (2004-2007)</b>			501953 00 01	Engine Guard		506162 00 01	Tank ring Lock-it	905
600101 00 02	Sissybar without rack	8,59	650946 00 01	Side carrier Lock-it		503938 00 01	Front Guard		516162 00 01	Tank ring Basic	705
400176 00 02	Twinlight Set		650946 01 01	Alurack		504953 00 01	Rear Guard		<b>CBR 600 F Sport (2001-2002)</b>		
<b>CBR 600 RR (2007-2016)</b>			661946 01 01	Easyrack		<b>CBR 600 F (1986-1990)</b>			506919 00 01	Tank ring Lock-it	905
506917 00 01	Tank ring Lock-it	905	501938 00 01	Engine Guard		650173 00 01	Complete carrier	5: A,B,C,D,E,F	516919 00 01	Tank ring Basic	705
516917 00 01	Tank ring Basic	705	503938 00 01	Front Guard		650173 01 01	Rear rack	22	650919 01 01	Rear rack	
670915 00 01	Sportrack	52	504938 00 01	Rear Guard		<b>CBR 600 F (1991-1992)</b>			<b>CB 650 RC / SC (1982-1984)</b>		
<b>CB 600 F Hornet / S (1998-2002)</b>			505938 00 01	Center stand		650184 00 01	Complete carrier	5: A,B,C,D,E,F	650117 00 02	Complete carrier	
650901 00 01	Complete carrier	0	506938 00 01	Tank ring Lock-it	905	506184 00 01	Tank ring Lock-it	905	<b>CB 650 Custom (1980-1981)</b>		
650901 01 01	Rear rack		516938 00 01	Tank ring Basic	705	516184 00 01	Tank ring Basic	705	650116 00 02	Complete carrier	
501117 00 02	Engine Guard		<b>NOTICE Tank rings HONDA</b>			650184 01 01	Rear rack	13	<b>CB 650 R (2019-2020)</b>		
505901 00 01	Center stand		Our tank ring Lock-it 506007-7 / Basic 516007-7 fits all Honda models with a 7 hole fixing and M6 screws.			<b>CBR 600 F (1993-1996)</b>			6529518 01 01	Alurack	
506117 00 01	Tank ring Lock-it	905				<b>CBR 600 F (1997-1998)</b>			650199 00 01	Complete carrier	5: A,B,C,D,E,F
516117 00 01	Tank ring Basic	705	506007-7	Tank ring Lock-it 7-hole		506199 00 01	Tank ring Lock-it	905	6609518 01 01	Minirack	
<b>CB 600 F Hornet (2003-2006)</b>			516007-7	Tank ring Basic 7-hole		516199 00 01	Tank ring Basic	705	6309518 00 01	C-Bow holder	
650935 00 01	Complete carrier	0	Our tank ring Lock-it 506013-5 / Basic 516013-5 fits all Honda models with 5 hole mounting.			650199 01 01	Rear rack	13, 22	5039518 00 01	Front Guard	
650935 01 01	Rear rack					<b>CBR 600 F (2007-2010)</b>			<b>CBR 600 F (1999-2010)</b>		
501117 00 02	Engine Guard		506013-5	Tank ring Lock-it 5-hole		650162 00 01	Side carrier		6709518 00 01	Sportrack	52
505935 00 01	Center stand		516013-5	Tank ring Basic 5-hole		506162 00 01	Tank ring Lock-it	905	5069518 00 01	Tank ring Lock-it	911
506935 00 01	Tank ring Lock-it	905	Our tank ring Lock-it 506018-7 / Basic 516018-7 fits all Honda models with a 7 hole fixing and M4 screws.			516162 00 01	Tank ring Basic	705	5169518 00 01	Tank ring Basic	711
516935 00 01	Tank ring Basic	705				506018-7	Tank ring Lock-it 7-hole		650162 01 01	Rear rack	22
<b>CB 600 F Hornet (2007-2010)</b>			516018-7	Tank ring Basic 7-hole		<b>CBR 600 F (1997-1998)</b>			5019518 00 01	Engine Guard incl. Protectionpad	
650948 00 01	Side carrier Lock-it		<b>ATTENTION: You can find the new 2024 models online at <a href="http://www.hepco-becker.de">www.hepco-becker.de</a></b>			650908 00 01	Side carrier		5089518 00 01	Engine Guard Solid	
650948 01 01	Alurack					650908 01 01	Rear rack				
661948 01 01	Easyrack					630919 00 01	C-Bow holder				
630948 00 01	C-Bow holder					506162 00 01	Tank ring Lock-it	905			
506948 00 01	Tank ring Lock-it	905				516162 00 01	Tank ring Basic	705			
516948 00 01	Tank ring Basic	705									
501948 00 01	Engine Guard										
503948 00 01	Front Guard										



Item-no.	Description	Infos	Item-no.	Description	Infos	Item-no.	Description	Infos	Item-no.	Description	Infos
<b>CB 650 R (2021-)</b>			<b>NX 650 Dominator (1992-1994)</b>			<b>Africa Twin XRV 650 (1988-1990)</b>			<b>CBR 650 R (2019-2020)</b>		
6529529 01 01	Alurack		650189 00 01	Side carrier		650177 00 01	Side carrier	0	6529519 01 01	Alurack	
6619529 01 01	Easyrack		650189 01 01	Rear rack	8 9,3:83	650177 01 01	Rear rack	9	6619519 01 01	Easyrack	
6609529 01 01	Minirack		501101 00 01	Engine Guard		502104 00 01	Engine Guard		6609519 01 01	Minirack	
6309529 00 01	C-Bow holder		<b>NX 650 Dominator (1995-2002)</b>			502104 00 03	Engine Guard		6309519 00 01	C-Bow holder	
5039529 00 01	Front Guard		650134 00 01	Side carrier		800171 00 09	Rear rack enlargement		6709519 00 01	Sportrack	52
5049529 00 01	Rear Guard		650134 01 01	Rear rack	9	<b>XL 650 V Transalp (2000-2007)</b>			5069519 00 01	Tank ring Lock-it	911
6709529 00 01	Sportrack	52	501113 00 01	Engine Guard		650917 00 01	Side carrier	0	5169519 00 01	Tank ring Basic	711
5069529 00 01	Tank ring Lock-it	911	800171 00 09	Rear rack enlargement		650917 01 01	Rear rack	9	42119519 00 91	Side stand enlargement	
5169529 00 01	Tank ring Basic	711	<b>SLR 650 (1997-1999)</b>			502110 00 01	Engine Guard		<b>CBR 650 R (2021-)</b>		
42119529 00 91	Side stand enlargement		650133 00 02	Side carrier		502111 00 01	Tank Guard		6309532 00 01	C-Bow holder	
5019529 00 01	Engine Guard incl. Protectionpad		650133 01 01	Rear rack	9	505917 00 01	Center stand		5069532 00 01	Tank ring Lock-it	911
5089529 00 01	Engine Guard Solid		502108 00 01	Engine Guard		800917 00 09	Rear rack enlargement		5169532 00 01	Tank ring Basic	711
<b>CX 650 Euro (1983-1986)</b>			800171 00 09	Rear rack enlargement		<b>CBR 650 F (2014-2018)</b>			6709532 00 01	Sportrack	52
650112 00 01	Complete carrier	6	<b>Vigor 650 (1999-2002)</b>			650982 00 01	Side carrier Lock-it		6529532 01 01	Alurack	
650112 01 01	Rear rack	22	650911 01 02	Rear rack		650982 01 01	Alurack		6619532 01 01	Easyrack	
<b>FMX 650 (2005-2007)</b>			502108 00 01	Engine Guard		661982 01 01	Easyrack		6609532 01 01	Minirack	
650942 01 01	Rear rack		<b>NT 650 V Deauville (1998-2005)</b>			630982 00 01	C-Bow holder		42119532 00 91	Side stand enlargement	150
501942 00 01	Engine Guard		650907 01 01	Rear rack		506982 00 01	Tank ring Lock-it	911	<b>NT 700 V Deauville (2006-2012)</b>		
<b>GL 650 Silver Wing (1983-1984)</b>			501122 00 01	Engine Guard		516982 00 01	Tank ring Basic	711	650944 01 01	Rear rack	
650111 00 02	Complete carrier	21, 2; A1, A2, F	506122 00 01	Tank ring Lock-it	905	4211982 00 91	Side stand enlargement		506944 00 01	Tank ring Lock-it	905
<b>NT 650 Hawk GT (1988-1991)</b>			516122 00 01	Tank ring Basic	705	<b>CB 650 F (2014-)</b>			516944 00 01	Tank ring Basic	705
506186 00 01	Tank ring Lock-it	905	<b>NOTICE Tank rings HONDA</b>			650983 00 01	Side carrier Lock-it		501944 00 01	Tank Guard	
516186 00 01	Tank ring Basic	705	Our tank ring Lock-it 506007-7 / Basic 516007-7 fits all Honda models with a 7 hole fixing and M6 screws.			650983 01 01	Alurack		<b>XL 700 V Transalp (2008-2012)</b>		
650186 00 01	Complete carrier	5: A,B, C,D,E,F	506007-7	Tank ring Lock-it 7-hole		661983 01 01	Easyrack		650952 00 01	Side carrier Lock-it	0
<b>NTV 650 (1988-1998)</b>			516007-7	Tank ring Basic 7-hole		630983 00 01	C-Bow holder		650952 01 01	Alurack	9
650191 00 01	Complete carrier	37	Our tank ring Lock-it 506013-5 / Basic 516013-5 fits all Honda models with 5 hole mounting.			501983 00 01	Engine Guard incl. Protectionpad		661952 01 01	Easyrack	9
506191 00 01	Tank ring Lock-it	905	506013-5	Tank ring Lock-it 5-hole		503983 00 01	Front Guard (-2016)		630952 00 01	C-Bow holder	
516191 00 01	Tank ring Basic	705	516013-5	Tank ring Basic 5-hole		5039505 00 01	Front Guard (2017-)		502114 00 01	Engine Guard	
650191 01 01	Rear rack	22	Our tank ring Lock-it 506018-7 / Basic 516018-7 fits all Honda models with a 7 hole fixing and M4 screws.			504983 00 01	Rear Guard		810952 00 12	Skid plate	103
501109 00 01	Engine Guard		506018-7	Tank ring Lock-it 7-hole		506983 00 01	Tank ring Lock-it	911	505952 00 01	Center stand	
<b>NX 650 Dominator (1988-1991)</b>			516018-7	Tank ring Basic 7-hole		516983 00 01	Tank ring Basic	711	800952 00 09	Rear rack enlargement	
650175 00 01	Side carrier		Our tank ring Lock-it 506018-7 / Basic 516018-7 fits all Honda models with a 7 hole fixing and M4 screws.			4211983 00 91	Side stand enlargement		700952 00 01	Headlight grille	112
650175 01 01	Rear rack	9,3:83	506018-7	Tank ring Lock-it 7-hole		<b>CB 650 F (2014-)</b>			506114 00 01	Tank ring Lock-it	905
501101 00 01	Engine Guard		516018-7	Tank ring Basic 7-hole		650983 00 01	Side carrier Lock-it		516114 00 01	Tank ring Basic	705



**ATTENTION: You can find the new 2024 models online at [www.hepco-becker.de](http://www.hepco-becker.de)**



Info reference see p. 271

The last digit of the item-no. refers to the colours: 01= black 02= chrome 03= white 04= red 05= anthracite 06= orange 08= yellow 09= silver 10= blue metallic 12= Alu brushed 22= Stainless steel 91= silver/black

Item-no.	Description	Infos
<b>Integra 700 (2012-2013)</b>		
650972 00 01	Side carrier Lock-it	
650972 01 01	Alurack	68
661972 01 01	Easyrack	68
630972 00 01	C-Bow holder	37
<b>NC 700 S (2012-2013)</b>		
650970 00 01	Side carrier Lock-it	37
650970 01 01	Alurack	
661970 01 01	Easyrack	
630970 00 01	C-Bow holder	
501970 00 01	Engine Guard	
731107	LED auxiliary headlights Nova	133
503970 00 01	Front Guard	
504970 00 01	Rear Guard Lock-it	
810970 00 12	Skid plate	132
505970 00 01	Center stand	
4211970 00 91	Side stand enlargement	

<b>NOTICE Tank rings HONDA</b>		
Our tank ring Lock-it 506007-7 / Basic 516007-7 fits all Honda models with a 7 hole fixing and M6 screws.		
506007-7	Tank ring Lock-it 7-hole	
516007-7	Tank ring Basic 7-hole	
Our tank ring Lock-it 506013-5 / Basic 516013-5 fits all Honda models with 5 hole mounting.		
506013-5	Tank ring Lock-it 5-hole	
516013-5	Tank ring Basic 5-hole	
Our tank ring Lock-it 506018-7 / Basic 516018-7 fits all Honda models with a 7 hole fixing and M4 screws.		
506018-7	Tank ring Lock-it 7-hole	
516018-7	Tank ring Basic 7-hole	

Item-no.	Description	Infos
<b>NC 700 X (2012-2013)</b>		
650973 00 01	Side carrier Lock-it	37
650973 01 01	Alurack	
661973 01 01	Easyrack	
630973 00 01	C-Bow holder	
501973 00 01	Engine Guard	
731107	LED auxiliary headlights Nova	133
810973 00 12	Skid plate	132
503973 00 01	Front Guard	
504973 00 01	Rear Guard Lock-it	
505973 00 01	Center stand	
4211973 00 91	Side stand enlargement	
<b>CTX 700 / N / DCT (2014-)</b>		
650984 00 01	Side carrier Lock-it	68
650984 01 01	Alurack	
661984 01 01	Easyrack	
630984 00 01	Lock-it C-Bow holder	
501984 00 01	Engine Guard	
611984 00 01	Sissybar with rack	
600984 00 01	Sissybar without rack	8,59
505984 00 01	Center stand	
4211984 00 91	Side stand enlargement	
<b>CB 750 Four K0-K6, (1970-1976)</b>		
650997 00 02	Complete carrier	
653997 00 02	Side carrier	96
654997 01 02	Rear rack	22
501997 00 02	Engine Guard	
<b>CB 750 Custom (1981-1984)</b>		
650120 00 02	Complete carrier	
<b>CB 750 F 1 / F 2 (1977-1978)</b>		
650118 00 02	Complete carrier	
<b>CB 750 FA / FB (1980-1984)</b>		
650125 00 02	Complete carrier	21, 2: A1, A2, F
650125 01 02	Rear rack	22

Item-no.	Description	Infos
<b>CB 750 FC / FD / F2 (1980-1984)</b>		
650161 00 02	Complete carrier	21, 2: A1, A2, F
650161 01 02	Rear rack	22
<b>CB 750 K 7 (1977-1978)</b>		
650121 00 02	Complete carrier	
<b>CB 750 KA / KB / KZ (1979-1984)</b>		
650119 00 02	Complete carrier	
<b>CBX 750 F (1984-1986)</b>		
650152 00 01	Complete carrier	18,22
650152 01 01	Rear rack	22
<b>CB 750 F sevenfifty (1992-2003)</b>		
650187 00 01	Complete carrier	3:D
650187 01 01	Alurack	22
661187 01 01	Easyrack	22
501104 00 02	Engine Guard	
506187 00 01	Tank ring Lock-it	917
516187 00 01	Tank ring Basic	717
<b>CB 750 Hornet (2023-)</b>		
6509541 00 01	Side carrier Lock-it	170
6309541 00 01	C-Bow holder	178
5089541 00 01	Engine guard Solid	
5019541 00 01	Engine guard	
6529541 01 01	Alurack	
6619541 01 01	Easyrack	
6609541 01 01	Minirack	
6709541 00 01	Sportrack	
5069541 00 01	Tank ring Lock-it	911
5169541 00 01	Tank ring Basic	711
42159541 00 09	Pillion footrest lowering kit	50
5039541 00 01	Front guard	
5049541 00 01	Rear guard	
42119541 00 91	Side stand enlargement	

Item-no.	Description	Infos
<b>Forza 750 (2021-)</b>		
6309528 00 01	C-Bow holder	147, 3: H, K2
6529528 01 01	Alurack	
6619528 01 01	Easyrack	
6609528 01 01	Minirack	
42199528 00 01	Pillion handle	96
42119528 00 91	Side stand enlargement	
6109528 00 01	Topcase Railing	197
<b>VF 750 Custom (1982-1984)</b>		
650123 00 02	Complete carrier	5: A, B, C, D, E, F
650123 01 02	Rear rack	13
<b>VF 750 F (1983-1986)</b>		
650150 00 01	Complete carrier	
650150 01 01	Rear rack	22
<b>VF 750 S (1982-1985)</b>		
650122 00 01	Complete carrier	
650122 01 01	Rear rack	22
<b>VFR 750 F (1986 - 1987)</b>		
650169 00 01	Complete carrier	
650169 01 01	Rear rack	22
<b>VFR 750 F (1988 - 1989)</b>		
650179 00 01	Complete carrier	38
650179 01 01	Rear rack	22
<b>VFR 750 F (1990-1993)</b>		
650183 00 01	Side carrier	
506183 00 01	Tank ring Lock-it	905
516183 00 01	Tank ring Basic	705
<b>VFR 750 F (1994-1997)</b>		
650158 00 01	Side carrier	
650158 01 01	Rear rack	
506158 00 01	Tank ring Lock-it	905
516158 00 01	Tank ring Basic	705

**ATTENTION: You can find the new 2024 models online at [www.hepco-becker.de](http://www.hepco-becker.de)**



Item-no.	Description	Infos	Item-no.	Description	Infos	Item-no.	Description	Infos	Item-no.	Description	Infos
<b>VF 750 C (1993-2000)</b>			<b>VT 750 Shadow (2004 -2007)</b>			<b>VT 750 Shadow Spirit (2007-2013)</b>			<b>X-ADV 750ccm (2021-)</b>		
650151 00 02	Complete carrier		650939 00 02	Side carrier		650951 00 02	Side carrier		6539531 00 01	Side carrier	147
650151 01 02	Rear rack	13,22	650939 01 02	Rear rack		650951 01 02	Rear rack		6309531 00 01	C-Bow holder	147
625151 00 02	Leather bag holder tube type	3:P,S	630939 00 02	C-Bow leather bag holder		630951 00 02	C-Bow leather bag holder		42199531 00 01	Pillion handle	23,96, 208
501107 00 02	Engine Guard		625939 00 02	Leather bag holder tube type		625951 00 02	Leather bag holder tube type		5019531 00 01	Engine Guard	
611103 00 02	Sissybar with rack	8,59	501939 00 02	Engine Guard		501951 00 02	Engine Guard		5019531 00 09	Engine Guard	
600103 00 02	Sissybar without rack	59	611939 00 02	Sissybar with rack	59	611951 00 02	Sissybar with rack	59	6529531 01 01	Alurack	
611108 00 02	Solorack with pad	59	600939 00 02	Sissybar without rack	59	600951 00 02	Sissybar without rack	59	6619531 01 01	Easyrack	
600108 00 02	Solorack without pad	59	611118 00 02	Solorack with pad	59	400951 00 02	Twinlight Set		6609531 01 01	Minirack	
400151 00 02	Twinlight Set		600118 00 02	Solorack without pad	59	400952 00 02	Twinlight Set (with Pane)	67	42129531 00 01	Handle Guard	
<b>VT 750 C (1987-1989)</b>			410939 00 02	Fender Guard		<b>X-ADV 750ccm (2017-2020)</b>			42239531 00 01	Muffler Guard	
650916 00 02	Complete carrier		400939 00 02	Twinlight Set		653999 00 01	Side carrier	147	4109531 00 01	Fender Guard	
650916 01 02	Rear rack	22	<b>VT 750 Shadow (2008-)</b>			630999 00 01	C-Bow holder	147	42119531 00 91	Side stand enlargement	
<b>VT 750 C2 (1997-2001)</b>			650955 00 02	Side carrier		4219999 00 01	Reling	23,96, 208	5039531 00 01	Front Guard	129
650159 00 02	Side carrier	59	650955 01 02	Rear rack		501999 00 01	Engine Guard		5039531 00 09	Front Guard	129
650159 01 02	Rear rack		630955 00 02	C-Bow leather bag holder		501999 00 09	Engine Guard		<b>XLV 750 R (1983-1985)</b>		
625159 00 02	Leather bag holder tube type		625955 00 02	Leather bag holder tube type		652999 01 01	Alurack		650155 00 01	Side carrier	
501116 00 02	Engine Guard		501955 00 02	Engine Guard		661999 01 01	Easyrack		<b>VT 750 S / RS (2010-2011)</b>		
611110 00 02	Sissybar with rack	59	611955 00 02	Sissybar with rack	59	660999 01 01	Minirack		630963 00 02	C-Bow leather bag holder	
600110 00 02	Sissybar without rack	59	600955 00 02	Sissybar without rack	59	4212999 00 01	Handle Guard		611963 00 02	Sissybar with rack	59
611111 00 02	Solorack with pad	59	611120 00 02	Solorack with pad	59	4223999 00 01	Muffler Guard		600963 00 02	Sissybar without rack	59
600111 00 02	Solorack without pad	59	600120 00 02	Solorack without pad	59	410999 00 01	Fender Guard		501963 00 02	Cooler protection bars	
400159 00 02	Twinlight Set		410955 00 02	Fender Guard		4211999 00 91	Side stand enlargement		400963 00 02	Twinlight Set	
<b>VT 750 D2 Black Widow (2001-2003)</b>			400955 00 02	Twinlight Set		503999 00 01	Front Guard	129	<b>NOTICE Tank rings HONDA</b>		
625918 00 02	Leather bag holder tube type	3:P,S	400956 00 02	Twinlight Set (for Pane)	67	503999 00 09	Front Guard	129	Our tank ring Lock-it 506007-7 / Basic 516007-7 fits all Honda models with a 7 hole fixing and M6 screws.		
650918 01 02	Rear rack										
501918 00 02	Engine Guard										
611918 00 02	Sissybar with rack	59									
600918 00 02	Sissybar without rack	59									
410918 00 02	Fender Guard										
400918 00 02	Twinlight Set										
400919 00 02	Twinlight Set (with Pane)	67									



**ATTENTION: You can find the new 2024 models online at [www.hepco-becker.de](http://www.hepco-becker.de)**



Info reference see p. 271

The last digit of the item-no. refers to the colours: 01= black 02= chrome 03= white 04= red 05= anthracite 06= orange 08= yellow 09= silver 10= blue metallic 12= Alu brushed 22= Stainless steel 91= silver/black

Item-no.	Description	Infos
<b>Africa Twin XRV 750 (1990-1992)</b>		
650182 00 01	Side carrier	0
650182 01 01	Rear rack	9
502104 00 01	Engine Guard	
502104 00 03	Engine Guard	
<b>Africa Twin XRV 750 (1993-2003)</b>		
650147 00 01	Side carrier	30,53, 2- A1,A2,F
650147 01 01	Rear rack	9
502107 00 01	Engine Guard	
502107 00 03	Engine Guard	
505147 00 01	Center stand	
800171 00 09	Rear rack enlargement	
<b>Integra 750 / DCT (2014-2015)</b>		
650988 00 01	Side carrier Lock-it	
650988 01 01	Alurack	68
661988 01 01	Easyrack	68
630988 00 01	C-Bow holder	
<b>NC 750 S / DCT (2014-)</b>		
650970 00 01	Side carrier Lock-it	37
650970 01 01	Alurack	
661970 01 01	Easyrack	
630970 00 01	C-Bow holder	
501970 00 01	Engine Guard	
731107	LED auxiliary headlights Nova	133
503970 00 01	Front Guard	
504970 00 01	Rear Guard Lock-it	
810970 00 12	Skid plate	132
505970 00 01	Center stand	
4211970 00 91	Side stand enlargement	

Item-no.	Description	Infos
<b>NC 750 X / DCT (2014-2020)</b>		
650973 00 01	Side carrier Lock-it	37
650973 01 01	Alurack	
661973 01 01	Easyrack	
630973 00 01	C-Bow holder	
506974 00 01	Tank ring Lock-it	7
516974 00 01	Tank ring Basic	7
501973 00 01	Engine Guard	
731107	LED auxiliary headlights Nova	133
503973 00 01	Front Guard	
504973 00 01	Rear Guard Lock-it	
810973 00 12	Skid plate	132
505973 00 01	Center stand	
4211974 00 91	Side stand enlargement	
<b>NC 750 X / DCT (2021-)</b>		
6509530 00 01	Side carrier Lock-it	186
6309530 00 01	C-Bow holder	
6529530 01 01	Alurack	
6619530 01 01	Easyrack	
6609530 01 01	Minirack	
5019530 00 01	Engine Guard incl. Protec- tionpad	
5059530 00 01	Center stand	
42119530 00 91	Side stand enlargement	
5039530 00 01	Front Guard	
8119530 00 12	Skid plate	145
6109530 00 01	Topcase Railing	197

Item-no.	Description	Infos
<b>XL 750 Transalp (2023-)</b>		
6539539 00 01	Side carrier	
6309539 00 01	C-Bow holder	
6559539 01 01	Alurack f. original rack	
6629539 01 01	Easyrack f. original rack	
8009539 00 01	Rear rack enlargement	229
5069539 00 01	Tank ring Lock-it	911
5169539 00 01	Tank ring Basic	711
5019539 00 09	Engine guard	205
5019539 00 01	Engine guard	205
5029539 00 09	Tank guard	218
5029539 00 01	Tank guard	218
42139539 00 01	Adapter set for tank guard and engine guard	215
42249539 00 01	Additional plates for Engine guard	216
640100 00 01	Crash bar bag set V1	
8109539 00 01	Skid plate	216
8109539 00 12	Skid plate	216
42129539 00 01	Handle guard	222
7009539 00 01	Headlight grille	112
42269539 00 01	Adapter for original auxiliary headlights	217
731107	LED auxiliary headlights Nova	133
5059539 00 01	Center stand	
42119539 00 91	Side stand enlargement	
6109539 00 01	Top case railing	197
<b>VFR 800 (1998-2001)</b>		
650902 00 01	Side carrier	
506902 00 01	Tank ring Lock-it	905
516902 00 01	Tank ring Basic	705
650902 01 01	Rear rack	

Item-no.	Description	Infos
<b>VFR 800 (2002-2013)</b>		
650928 00 01	Side carrier	
650928 01 01	Rear rack	
506928 00 01	Tank ring Lock-it	905
516928 00 01	Tank ring Basic	705
<b>VFR 800 F (2014-2020)</b>		
650985 00 01	Side carrier Lock-it	
650985 01 01	Alurack	
661985 01 01	Easyrack	
630985 00 01	C-Bow holder	
506985 00 01	Tank ring Lock-it	911
516985 00 01	Tank ring Basic	711
<b>VFR 800 X Crossrunner (2011-2014)</b>		
650968 00 01	Side carrier Lock-it	75
650968 01 01	Alurack	75
661968 01 01	Easyrack	75
630968 00 01	C-Bow holder	
501968 00 01	Engine Guard	
505968 00 01	Center stand	
506968 00 01	Tank ring Lock-it	905
516968 00 01	Tank ring Basic	705

### NOTICE Tank rings HONDA

Our tank ring Lock-it 506007-7 / Basic 516007-7 fits all Honda models with a 7 hole fixing and M6 screws.

506007-7 Tank ring Lock-it 7-hole

516007-7 Tank ring Basic 7-hole

Our tank ring Lock-it 506013-5 / Basic 516013-5 fits all Honda models with 5 hole mounting.

506013-5 Tank ring Lock-it 5-hole

516013-5 Tank ring Basic 5-hole

Our tank ring Lock-it 506018-7 / Basic 516018-7 fits all Honda models with a 7 hole fixing and M4 screws.

506018-7 Tank ring Lock-it 7-hole

516018-7 Tank ring Basic 7-hole



**ATTENTION: You can find the new 2024 models online at [www.hepco-becker.de](http://www.hepco-becker.de)**



Item-no.	Description	Infos
<b>VFR 800 X Crossrunner (2015-2020)</b>		
650992 00 05	Side carrier Lock-it	24,75
650992 01 05	Alurack	75
661992 01 05	Easyrack	75,118
630992 00 05	C-Bow holder	
501992 00 01	Engine Guard	
640100 00 01	Crash bar bag set V1	
731107	LED auxiliary headlights Nova	133
505992 00 01	Center stand	
800992 00 05	Rear rack enlargement	
506992-5	Tank ring Lock-it	
516992-5	Tank ring Basic	
4211992 00 91	Side stand enlargement	
<b>CB 900 FA / FB (1981-1984)</b>		
650125 00 02	Complete carrier	21, 2; A1, A2, F
650125 01 02	Rear rack	27
<b>CB 900 FC / FD / F2 (1981-1984)</b>		
650161 00 02	Complete carrier	21, 2; A1, A2, F
650161 01 02	Rear rack	22

## NOTICE Tank rings HONDA

Our tank ring Lock-it 506007-7 / Basic 516007-7 fits all Honda models with a 7 hole fixing and M6 screws.

506007-7 Tank ring Lock-it 7-hole

516007-7 Tank ring Basic 7-hole

Our tank ring Lock-it 506013-5 / Basic 516013-5 fits all Honda models with 5 hole mounting.

506013-5 Tank ring Lock-it 5-hole

516013-5 Tank ring Basic 5-hole

Our tank ring Lock-it 506018-7 / Basic 516018-7 fits all Honda models with a 7 hole fixing and M4 screws.

506018-7 Tank ring Lock-it 7-hole

516018-7 Tank ring Basic 7-hole

Item-no.	Description	Infos
<b>CBR 900 RR (1998-1999)</b>		
650188 00 01	Side carrier	5: A,B, C,D,E,F
506188 00 01	Tank ring Lock-it	905
516188 00 01	Tank ring Basic	705
650188 01 01	Rear rack	22
<b>CBR 900 RR (2000-2001)</b>		
506914 00 01	Tank ring Lock-it	905
516914 00 01	Tank ring Basic	705
650914 01 01	Rear rack	
<b>CBR 900 RR (2002-2003)</b>		
650926 01 01	Rear rack	
<b>CB 900 Hornet (2002-2005)</b>		
650929 00 01	Side carrier	
650929 01 01	Rear rack	
630929 00 01	C-Bow holder	
501126 00 01	Engine Guard	
505929 00 01	Center stand	
506929 00 01	Tank ring Lock-it	905
516929 00 01	Tank ring Basic	705
<b>CBR 1000 F (1986-1988)</b>		
650172 00 01	Complete carrier	5: A,B, C,D,E,F
<b>CBR 1000 F (1989-1992)</b>		
650192 00 01	Complete carrier	5: A,B, C,D,E,F
506192 00 01	Tank ring Lock-it	905
516192 00 01	Tank ring Basic	705
650192 01 01	Rear rack	27
<b>CBR 1000 F (1993-1999)</b>		
650196 00 01	Complete carrier	5: A,B, C,D,E,F
506196 00 01	Tank ring Lock-it	905
516196 00 01	Tank ring Basic	705
650196 01 01	Rear rack	22

Item-no.	Description	Infos
<b>CB 1000 BIG 1 (1993-1996)</b>		
650197 00 02	Side carrier	
506197 00 01	Tank ring Lock-it	905
516197 00 01	Tank ring Basic	705
650197 01 01	Alurack	
661197 01 01	Easyrack	
<b>CBX 1000 (1978-1979)</b>		
650126 00 02	Complete carrier	
654126 01 02	Rear rack tube type	
653126 00 02	Side carrier	
501103 00 02	Engine Guard	
<b>CBX pro-link (1980-1983)</b>		
650127 00 02	Complete carrier	

Item-no.	Description	Infos
<b>CRF 1000L Africa Twin (2016-2017)</b>		
653994 00 01	Side carrier	0
650994 00 01	Side carrier Lock-it	0
651994 00 22	Cutout carrier	4:C3,C4
651994 00 22-00-40	Xplorer Cutout Set	
651994 00 22-01-40	Xplorer Cutout Set Black	
655994 01 01	Alurack	152
662994 01 01	Easyrack	152
630994 00 01	C-Bow holder	
800994 00 01	Rear rack enlargement	
501994 00 01	Engine Guard	144
501994 00 22	Engine Guard	144
502994 00 01	Tank Guard	
502994 00 22	Tank Guard	
4222994 00 01	Reinforcement bracket for Tank Guard	41
640100 00 01	Crash bar bag set V1	
505994 00 01	Center stand	
4217994 00 12	Center stand guard (Only suitable f. H&B- Center stand)	
810994 00 12	Skid plate	
506994 00 01	Tank ring Lock-it	916
516994 00 01	Tank ring Basic	716
700994 00 01	Headlight grilles	112, 131
4213994 00 01	Adapter for Headlight grilles	
4212994 00 01	Handle guard	
4210994 00 01	Support brace f. Rear rack	136
4210994 00 01	Holding set f. Support brace	137
741100 00 01	Tool box	
4211994 00 91	Side stand enlargement	



**ATTENTION: You can find the new 2024 models online at [www.hepco-becker.de](http://www.hepco-becker.de)**



Item-no.	Description	Infos
<b>CRF 1000L Africa Twin (2018-2019)</b>		
6539512 00 01	Side carrier	0
6519512 00 22	Cutout carrier	4:C3,C4
6519512 00 22-00-40	Xplorer Cutout Set	
6519512 00 22-01-40	Xplorer Cutout Set Black	
6559512 01 01	Alurack	
6629512 01 01	Easyrack	
6309512 00 01	C-Bow holder	
8009512 00 01	Rear rack enlargement	
5019512 00 01	Engine Guard	144
5019512 00 22	Engine Guard	144
5029512 00 01	Tank Guard	
5029512 00 22	Tank Guard	
42229512 00 01	Reinforcement bracket for Tank Guard	41
640100 00 01	Crash bar bag set V1	
5059512 00 01	Center stand	
42179512 00 12	Center stand guard	241
8109512 00 12	Skid plate	
5069512 00 01	Tank ring Lock-it	916
5169512 00 01	Tank ring Basic	716
7009512 00 01	Headlight grille	112, 131
42139512 00 01	Adapter for Headlight grille	
42129512 00 01	Handle Guard	
741100 00 01	Tool box	
42119512 00 91	Side stand enlargement	

Item-no.	Description	Infos
<b>CRF 1000L Africa Twin Adventure Sports (2018-2019)</b>		
6539510 00 01	Side carrier	0
6519510 00 22	Cutout carrier	4:C3,C4
6519510 00 22-00-40	Xplorer Cutout Set	
6519510 00 22-01-40	Xplorer Cutout Set Black	
6559510 01 01	Alurack	152
6629510 01 01	Easyrack	152
6309510 00 01	C-Bow holder	
8009510 00 01	Rear rack enlargement	
5019510 00 01	Engine Guard	
5019510 00 22	Engine Guard	
42229510 00 09	Reinforcement bracket f. original Tank Guard	159
640100 00 01	Crash bar bag set V1	
5059510 00 01	Center stand	
42179510 00 12	Center Stand Guard	
5069510 00 01	Tank ring Lock-it	916
5169510 00 01	Tank ring Basic	716
7009510 00 01	Headlight grille	112
42129510 00 01	Handle Guard	
42109510 00 01	Support brace f. Rear rack	136
42109510 00 01	Holding set f. Support brace	137
741100 00 01	Tool box	
42119510 00 91	Side stand enlargement	

Item-no.	Description	Infos
<b>GL 1000 (1979)</b>		
650128 00 02	Complete carrier	5: A,B, C,D,E,F

Item-no.	Description	Infos
<b>VF 1000 F (1984)</b>		
650153 00 01	Complete carrier	5: A,B, C,D,E,F
650153 01 01	Rear rack	22

Item-no.	Description	Infos
<b>VF 1000 F (1985-1987)</b>		
650166 00 01	Complete carrier	
650166 01 01	Rear rack	22

Item-no.	Description	Infos
<b>VF 1000 R (1984-1986)</b>		
650154 00 01	Complete carrier	
<b>VTR 1000 Firestorm (1997-2006)</b>		
650156 01 01	Rear rack	
506156 00 01	Tank ring Lock-it	905
516156 00 01	Tank ring Basic	705
<b>XL 1000 V Varadero (1999-2002)</b>		
650909 00 01	Side carrier	
650909 01 01	Rear rack	9
506909 00 01	Tank ring Lock-it	905
516909 00 01	Tank ring Basic	705
502109 00 01	Engine Guard	
505909 00 01	Center stand	
800934 00 09	Rear rack enlargement	
<b>XL 1000 V Varadero (2003-2006)</b>		
650934 00 01	Side carrier	
650934 01 01	Rear rack	9
506909 00 01	Tank ring Lock-it	905
516909 00 01	Tank ring Basic	705
502113 00 01	Engine Guard	
505909 00 01	Center stand	
800934 00 09	Rear rack enlargement	

Item-no.	Description	Infos
<b>NOTICE Tank rings HONDA</b>		
Our tank ring Lock-it 506007-7 / Basic 516007-7 fits all Honda models with a 7 hole fixing and M6 screws.		
506007-7	Tank ring Lock-it 7-hole	
516007-7	Tank ring Basic 7-hole	
Our tank ring Lock-it 506013-5 / Basic 516013-5 fits all Honda models with 5 hole mounting.		
506013-5	Tank ring Lock-it 5-hole	
516013-5	Tank ring Basic 5-hole	
Our tank ring Lock-it 506018-7 / Basic 516018-7 fits all Honda models with a 7 hole fixing and M4 screws.		
506018-7	Tank ring Lock-it 7-hole	
516018-7	Tank ring Basic 7-hole	

Item-no.	Description	Infos
<b>XL 1000 V Varadero (2007-2011)</b>		
650949 00 01	Side carrier Lock-it	
650949 01 01	Rear rack	9
506909 00 01	Tank ring Lock-it	905
516909 00 01	Tank ring Basic	705
502113 00 01	Engine Guard	
505909 00 01	Center stand	

Item-no.	Description	Infos
<b>CBR 1000 RR (2004-2005)</b>		
650940 01 01	Rear rack	
506940 00 01	Tank ring Lock-it	905
516940 00 01	Tank ring Basic	705

Item-no.	Description	Infos
<b>CBR 1000 RR Fireblade (2008-2013)</b>		
670913 00 01	Sportrack	52

Item-no.	Description	Infos
<b>CBR 1000 RR Fireblade SP (2014-2016)</b>		
670916 00 01	Sportrack	52
506916 00 01	Tank ring Lock-it	911
516916 00 01	Tank ring Basic	711

Item-no.	Description	Infos
<b>CBR 1000 RR Fireblade SP (2017-)</b>		
6709501 00 01	Sportrack	52
5069501 00 01	Tank ring Lock-it	911
5169501 00 01	Tank ring Basic	711

Item-no.	Description	Infos
<b>CBR 1000 RR-R / SP Fireblade (2020-)</b>		
6709524 00 01	Sportrack	52
5069524 00 01	Tank ring Lock-it	911
5169524 00 01	Tank ring Basic	711

Item-no.	Description	Infos
<b>CBF 1000 (2006-2011)</b>		
650947 00 01	Side carrier Lock-it	
650947 01 01	Alurack	
661947 01 01	Easyrack	
630947 00 01	C-Bow holder	
501943 00 01	Engine Guard	
506947 00 01	Tank ring Lock-it	905
516947 00 01	Tank ring Basic	705

**ATTENTION: You can find the new 2024 models online at [www.hepco-becker.de](http://www.hepco-becker.de)**





Item-no.	Description	Infos	Item-no.	Description	Infos	Item-no.	Description	Infos	Item-no.	Description	Infos
<b>CBF 1000 F (2010-2016)</b>			<b>CMX 1100 Rebel (2021-)</b>			<b>CRF 1100 L Africa Twin / DSG (2019-)</b>			<b>CRF 1100 L Africa Twin Adventure Sports (2020-2023)</b>		
650957 00 01	Side carrier Lock-it		6309525 00 01	C-Bow holder		6539521 00 01	Side carrier	0, 182	6539522 00 01	Side carrier	0,104
650957 01 01	Alurack		5069525 00 01	Tank ring Lock-it		6519521 00 22	Cutout carrier	4:C3,C4,182	6519522 00 22	Cutout carrier	4:C3,C4,104
661957 01 01	Easyrack		5169525 00 01	Tank ring Basic		6519521 00 22-00-40	Xplorer Cutout Set	182	6519522 00 22-00-40	Xplorer Cutout Set	104
630957 00 01	C-Bow holder		6529525 01 01	Alurack		6519521 00 22-01-40	Xplorer Cutout Set Black	182	6519522 00 22-01-40	Xplorer Cutout Set	104
501957 00 01	Engine Guard		6619525 01 01	Easyrack		6539522 00 01	Side carrier	0, 104	6559522 01 01	Alurack f. Original rack	
506957 00 01	Tank ring Lock-it	905	6609525 01 01	Minirack	10	6519522 00 22	Cutout carrier	4:C3,C4,104	6629522 01 01	Easyrack f. Original rack	
516957 00 01	Tank ring Basic	705	6139525 00 01	Solorack	84	6519522 00 22-00-40	Xplorer Cutout Set	104	8009522 00 01	Rear rack enlargement	104
<b>CB 1000 R (2008-2017)</b>			6009525 00 01 Sissybar without rack			6519522 00 22-01-40 Xplorer Cutout Set Black			5019522 00 01 Engine Guard		
650954 01 01	Alurack		6119525 00 01	Sissybar with rack		6529521 01 01	Alurack	182,183	5019522 00 22	Engine Guard	119,144 242
661954 01 01	Easyrack		42169525 00 01	Sissybar without rack (tube design)		6619521 01 01	Easyrack	182,183	5029522 00 01	Tank Guard	
630954 00 01	C-Bow holder		6129525 00 01	Sissybar with rack (tube design)		6559522 01 01	Alurack f. Original rack		5029522 00 22	Tank Guard	
630900 00 01	C-Bow holder for bikes with R+G rear modification		6589525 01 01	Rear rack tube type	189	6629522 01 01	Easyrack f. Original rack		42229522 00 01	Reinforcement bracket f. Tank Guard	211
670954 00 01	Sportrack	52	5019525 00 01	Engine Guard		6609521 01 01	Minirack		640100 00 01	Crash bar bag set V1	
506954 00 01	Tank ring Lock-it	905	7009525 00 01	Headlight grille	112	6309521 00 01	C-Bow holder	4:G1,199	5059522 00 01	Center stand	
516954 00 01	Tank ring Basic	705	4009525 00 01	Twinlight Set	204	8009521 00 01	Rear rack enlargement	182	42179522 00 12	Center Stand Guard	241
<b>CB 1000 R (2018-)</b>						8009522 00 01 Rear rack enlargement			5069522 00 01 Tank ring Lock-it		
6309509 00 01	C-Bow holder (2018-2020)	161				5019521 00 01 Engine Guard			5169522 00 01 Tank ring Basic		
6309533 00 01	C-Bow holder (2021-)	161				5019521 00 22 Engine Guard			7009522 00 01 Headlight grille		
6709509 00 01	Sportrack	52				5029521 00 01 Tank Guard			42139522 00 01 Adapter for Headlight grille		
5069509 00 01	Tank ring Lock-it	911				5029521 00 22 Tank Guard			42129522 00 01 Handle Guard		
5169509 00 01	Tank ring Basic	711									
5079509 00 01	Protection Pad										
<b>NOTICE Tank rings HONDA</b>											
Our tank ring Lock-it 506007-7 / Basic 516007-7 fits all Honda models with a 7 hole fixing and M6 screws.											
506007-7	Tank ring Lock-it 7-hole										
516007-7	Tank ring Basic 7-hole										
Our tank ring Lock-it 506013-5 / Basic 516013-5 fits all Honda models with 5 hole mounting.											
506013-5	Tank ring Lock-it 5-hole										
516013-5	Tank ring Basic 5-hole										
Our tank ring Lock-it 506018-7 / Basic 516018-7 fits all Honda models with a 7 hole fixing and M4 screws.											
506018-7	Tank ring Lock-it 7-hole										
516018-7	Tank ring Basic 7-hole										

**ATTENTION: You can find the new 2024 models online at [www.hepco-becker.de](http://www.hepco-becker.de)**



Info reference see p. 271

The last digit of the item-no. refers to the colours: 01= black 02= chrome 03= white 04= red 05= anthracite 06= orange 08= yellow 09= silver 10= blue metallic 12= Alu brushed 22= Stainless steel 91= silver/black

Item-no.	Description	Infos	Item-no.	Description	Infos	Item-no.	Description	Infos	Item-no.	Description	Infos
<b>CRF 1100 L Africa Twin Adventure Sports (2024-)</b>			<b>X-11 (2000-2003)</b>			<b>CB 1100 EX (2014-2016)</b>			<b>NT 1100 (2022-)</b>		
6519544 00 22	Cutout carrier	104	650912 00 01	Side carrier		650989 00 02	Side carrier Lock-it		6539537 00 01	Side carrier	
6519544 00 22-00-40	Xplorer Cutout Set	104	650912 01 01	Rear rack		650989 01 02	Rear rack		6559537 01 01	Alurack f. original rack	
6519544 00 22-01-40	Xplorer Cutout Set	104	501121 00 01	Engine Guard		630989 00 02	C-Bow holder		6629537 01 01	Easyrack f. original rack	
6539544 00 01	Side carrier	0,104	<b>CBR 1100 XX (1997-2007)</b>			501979 00 02	Engine Guard		5019537 00 01	Engine guard	193
5169544 00 01	Tank ring Basic	711	650138 00 01	Side carrier		<b>CB 1100 EX / RS (2017-2020)</b>			5029537 00 01	Tank guard	129
6559544 01 01	Alurack for original rack		650138 01 01	Alurack		6509502 00 01	Side carrier Lock-it (RS)	3:C,D,F	640100 00 01	Crash bar bag set V1	
6629544 01 01	Easyrack for original rack		661138 01 01	Easyrack		6309502 00 02	C-Bow holder (RS)	<sup>3</sup> H, K2,P,S	5069537 00 01	Tank ring Lock-it	916
8009544 00 01	Rear rack enlargement	104	506138 00 01	Tank ring Lock-it	905	6309502 00 01	C-Bow holder (RS)	<sup>3</sup> H, K2,P,S	5169537 00 01	Tank ring Basic	716
5029544 00 01	Tank guard		516138 00 01	Tank ring Basic	705	6509520 00 01	Side carrier Lock-it (EX)	3:C,D,F	42269537 00 01	Adapter for original auxiliary headlights	
5029544 00 22	Tank guard		<b>VT 1100 C (1988-1994)</b>			6309520 00 02	C-Bow holder (EX)	<sup>3</sup> H, K2,P,S	6109537 00 01	Topcase Railing	197
42229544 00 01	Reinforcement bracket f. Tank Guard		650170 01 02	Rear rack		6309520 00 01	C-Bow holder (EX)	<sup>3</sup> H, K2,P,S	5109537 00 01	Case guard	198
5019544 00 01	Engine guard	119,144 ,242	625170 00 02	Leather bag holder tube type	3:P,S	6619502 01 01	Easyrack		<b>VFR 1200 F (2010-2016)</b>		
5019544 00 22	Engine guard	119,144 ,242	501110 00 02	Engine Guard		6609502 01 01	Minirack		650960 00 01	Side carrier Lock-it	
42129544 00 01	Handle guard		600104 00 02	Sissybar without rack	59	5019502 00 02	Engine Guard		650960 01 01	Alurack	
7009544 00 01	Headlight grille	112,131	611104 00 02	Sissybar with rack	59	5069502 00 01	Tank ring Lock-it	911	661960 01 01	Easyrack	
42139544 00 01	Adapter for Headlight grille		<b>VT 1100 C2 Shadow (1995-2000)</b>			5169502 00 01	Tank ring Basic	711	630960 00 01	C-Bow holder	
640100 00 01	Crash bar bag set V1		650148 00 02	Complete carrier		<b>VT 1100 C3 Shadow (1998-2001)</b>			505960 00 01	Center stand	
741100 00 01	Tool box		650148 01 02	Rear rack	22	650906 00 02	Side carrier		506960 00 01	Tank ring Lock-it	905
731107	Nova LED Auxiliary headlights		625148 00 02	Leather bag holder tube type	3:P,S	650906 01 02	Rear rack		516960 00 01	Tank ring Basic	705
5059544 00 01	Center stand		501111 00 02	Engine Guard		625906 00 02	Leather bag holder tube type		700007263	Pillion handle optional f. Side carrier 650960 00 01	96
42179544 00 12	Center Stand Guard	241	611105 00 02	Sissybar with rack	59	501118 00 02	Engine Guard		<b>NOTICE Tank rings HONDA</b>		
42119544 00 91	Side stand enlargement		600105 00 02	Sissybar without rack	59	611113 00 02	Sissybar with rack	59	Our tank ring Lock-it 506007-7 / Basic 516007-7 fits all Honda models with a 7 hole fixing and M6 screws.		
42119522 00 91	Side stand enlargement		611109 00 02	Solorack with pad	59	600113 00 02	Sissybar without rack	59	506007-7	Tank ring Lock-it 7-hole	
<b>GL 1100 / DL (1980-1983)</b>			600109 00 02	Solorack without pad	59	611112 00 02	Solorack with pad	59	516007-7	Tank ring Basic 7-hole	
650130 00 02	Complete carrier		400148 00 02	Twinlight Set		600112 00 02	Solorack without pad	59	Our tank ring Lock-it 506013-5 / Basic 516013-5 fits all Honda models with 5 hole mounting.		
<b>ST 1100 Pan European (1990-2001)</b>			<b>CB 1100 (2013-2016)</b>			400906 00 02	Twinlight Set		506013-5	Tank ring Lock-it 5-hole	
650193 01 01	Rear rack		650979 00 02	Side carrier Lock-it		<b>VT 1100 Custom (1983-1986)</b>			516013-5	Tank ring Basic 5-hole	
650132 00 02	Complete carrier		650979 01 02	Rear rack	10	650979 01 02	Rear rack	10	Our tank ring Lock-it 506018-7 / Basic 516018-7 fits all Honda models with a 7 hole fixing and M4 screws.		
			630979 00 02	C-Bow holder		630979 00 02	C-Bow holder		506018-7	Tank ring Lock-it 7-hole	
			501979 00 02	Engine Guard		501979 00 02	Engine Guard		516018-7	Tank ring Basic 7-hole	



**ATTENTION: You can find the new 2024 models online at [www.hepco-becker.de](http://www.hepco-becker.de)**



Item-no.	Description	Infos
<b>Crosstourer (2012-2020)</b>		
650971 00 01	Side carrier Lock-it	
650971 01 01	Alurack	9
660971 01 01	Minirack	10,72
661971 01 01	Easyrack	9
630971 00 01	Lock-it C-Bow holder	
501971 00 01	Engine Guard	97
810971 00 01	Skid plate	
505971 00 01	Center stand	
800971 00 09	Rear rack enlargement	
731107	LED auxiliary headlights Nova	133
420971-01	Kardan protection Alu	
420971-02	Cover right	
420971-03	Handle Guard (2012-2017)	
506972 00 01	Tank ring Lock-it (7-Hole)	905
506971 00 01	Tank ring Lock-it (5-Hole)	911
516972 00 01	Tank ring Basic (7-Hole)	705
516971 00 01	Tank ring Basic (5-Hole)	711
4211971 00 91	Side stand enlargement	
<b>ST 1300 Pan European (2002-2016)</b>		
506927 00 01	Tank ring Lock-it	911
516927 00 01	Tank ring Basic	711
650927 01 01	Rear rack	
<b>VTX 1300 (2003-2007)</b>		
650931 00 02	Side carrier	
650931 01 02	Rear rack	
625931 00 02	Leather bag holder tube type	
501931 00 02	Engine Guard	
611931 00 02	Sissybar with rack	59
600931 00 02	Sissybar without rack	59
611117 00 02	Solorack with pad	59
600117 00 02	Solorack without pad	59
400931 00 02	Twinlight Set	

Item-no.	Description	Infos
<b>VT 1300 CX (2010-2012)</b>		
630962 00 02	C-Bow leather bag holder	
501962 00 02	Decoration bow	101
420962 00 02	Cooler cover	101
611962 00 02	Solorack with pad	59
600962 00 02	Solorack without pad	59
400962 00 02	Twinlight Set	
<b>CB 1300 (2002)</b>		
650925 00 01	Complete carrier	
506925 00 01	Tank ring Lock-it	905
516925 00 01	Tank ring Basic	705
501125 00 01	Engine Guard	
<b>CB 1300 (2003-2009)</b>		
650933 00 01	Side carrier	
650933 01 01	Alurack	
661933 01 01	Easyrack	
630933 00 01	C-Bow holder	
501933 00 01	Engine Guard	
506933 00 01	Tank ring Lock-it	905
516933 00 01	Tank ring Basic	705
<b>CB 1300 (2010)</b>		
650961 00 01	Side carrier Lock-it	
650961 01 01	Alurack	
661961 01 01	Easyrack	
630961 00 01	C-Bow holder	
501961 00 01	Engine Guard	
505961 00 01	Center stand (2003-2007)	
506961 00 01	Tank ring Lock-it	905
516961 00 01	Tank ring Basic	705
<b>F 6 C Custom (1997-2001)</b>		
650135 00 02	Side carrier	
650135 01 02	Rear rack	
625135 00 02	Leather bag holder tube type	
400135 00 02	Twinlight Set	

Item-no.	Description	Infos
<b>VTX 1800 (2001-2006)</b>		
650920 00 02	Side carrier	
650920 01 02	Rear rack	
625920 00 02	Leather bag holder tube type	
501123 00 02	Engine Guard	
611920 00 02	Sissybar with rack	59
600920 00 02	Sissybar without rack	59
611116 00 02	Solorack with pad	59
600116 00 02	Solorack without pad	59
400920 00 02	Twinlight Set	

## NOTICE Tank rings HONDA

Our tank ring Lock-it 506007-7 / Basic 516007-7 fits all Honda models with a 7 hole fixing and M6 screws.

506007-7 Tank ring Lock-it 7-hole

516007-7 Tank ring Basic 7-hole

Our tank ring Lock-it 506013-5 / Basic 516013-5 fits all Honda models with 5 hole mounting.

506013-5 Tank ring Lock-it 5-hole

516013-5 Tank ring Basic 5-hole

Our tank ring Lock-it 506018-7 / Basic 516018-7 fits all Honda models with a 7 hole fixing and M4 screws.

506018-7 Tank ring Lock-it 7-hole

516018-7 Tank ring Basic 7-hole

**ATTENTION: You can find the new 2024 models online at [www.hepco-becker.de](http://www.hepco-becker.de)**



Item-no.	Description	Info's	Item-no.	Description	Info's	Item-no.	Description	Info's	Item-no.	Description	Info's
<b>D-Tracker 125 (2010-2013) / KLX 125 (2010-2015)</b>			<b>EL 250 (1994-1994) / EL 252 (1996-2003)</b>			<b>Z 250 (2019-)</b>			<b>Ninja 400 (2018-)</b>		
6502513 01 01	Rear rack	71	650251 00 02	Complete carrier		6302542 00 01	C-Bow holder		6302532 00 01	C-Bow holder	
6302513 00 01	C-Bow holder		650251 01 02	Rear rack		6702542 00 01	Sportrack	52	6702532 00 01	Sportrack	52
<b>EL 125 (1998-2007)</b>			625251 00 02	Leather bag holder tube type		5062542 00 09	Tank ring Lock-it (-2021)	913	5062532 00 09	Tank ring Lock-it (2018-2021)	913
650279 00 02	Side carrier		501206 00 02	Engine guard		5162542 00 09	Tank ring Basic (-2021)	713	5162532 00 09	Tank ring Basic (2018-2021)	713
650279 01 02	Rear rack		611203 00 02	Sissybar with rack	59	5062542 01 09	Tank ring Lock-it (2022-)	919	5062532 01 09	Tank ring Lock-it (2022-)	919
650280 01 02	Rear rack	35	600203 00 02	Sissybar without rack	59	5162542 01 09	Tank ring Basic (2022-)	719	5162532 01 09	Tank ring Basic (2022-)	719
625279 00 02	Leather bag holder tube type		<b>KLR 250 (1985-1991)</b>			<b>Ninja 300 (2013-2017)</b>			42112532 00 91	Side stand enlargement	
501215 00 02	Engine guard		650236 00 01	Complete carrier	0	630253 00 01	C-Bow holder		<b>Z 400 (2019-)</b>		
<b>J125 / 300 (2014-)</b>			650236 01 01	Rear rack		670253 00 01	Sportrack	52	6302538 00 01	C-Bow holder	
6552520 01 01	Alurack		<b>KLX 250 (2009-2016)</b>			506253 00 01	Tank ring Lock-it	900	6702538 00 01	Sportrack	52
6622520 01 01	Easyrack		6502508 01 01	Alurack		516253 00 01	Tank ring Basic	700	5062538 00 09	Tank ring Lock-it (2019-202)	913
<b>Ninja 125 (2018-)</b>			6612508 01 01	Easyrack		<b>Z 300 (2015-2017)</b>			5162538 00 09	Tank ring Basic (2019-202)	713
6602537 01 01	Minirack		<b>Ninja 250 R (2008-2012)</b>			6302521 00 01	C-Bow holder		5062538 01 09	Tank ring Lock-it (2022-)	919
6302537 00 01	C-Bow holder		6502509 01 01	Alurack		6702521 00 01	Sportrack	52	5162538 01 09	Tank ring Basic (2022-)	719
5062537 00 01	Tank ring Lock-it (2018-2020)	900	6612509 01 01	Easyrack		506252 00 01	Tank ring Lock-it	900	42112538 00 91	Side stand enlargement	
5162537 00 01	Tank ring Basic (2018-2020)	700	5062509 00 01	Tank ring Lock-it	900	516252 00 01	Tank ring Basic	700	5012538 00 01	Engine guard	
5062519 00 09	Tank ring Lock-it (2021)	913	5162509 00 01	Tank ring Basic	700	<b>Versys- X 300 / Urban / Adventure (2017-)</b>			5032538 00 01	Front guard	
5162519 00 09	Tank ring Basic (2021)	713	<b>Notice tank rings KAWASAKI</b>			6302526 00 01	C-Bow holder		<b>Z 400 / 440 A / B / C (1976-1979)</b>		
5062519 01 09	Tank ring Lock-it (2022-)	919	Our tank ring Lock-it 506008-7 / Basic 516008-7 fits all KAWASAKI models with 7 hole mounting.			5012526 00 01	Engine guard		650203 00 02	Complete carrier	
5162519 01 09	Tank ring Basic (2022-)	719	506008-7	Tank ring Lock-it 7 hole		6552526 01 01	Alurack f. Original rack		<b>Z 400 J (1980-1982)</b>		
42112537 00 91	Side stand enlargement		516008-7	Tank ring Basic 7 hole		6622526 01 01	Easyrack f. Original rack		650204 00 02	Complete carrier	5: A,B, C,D,E,F
6702537 00 01	Sportrack	52	Our tank ring Lock-it 506002-5 / Basic 516002-5 fits all KAWASAKI models with 5 hole mounting.			5062526 00 09	Tank ring Lock-it (-2021)	913	<b>Z 440 LTD KETTE (1980-1982)</b>		
<b>Z 125 (2018-)</b>			506002-5	Tank ring Lock-it 5 hole		5162526 00 09	Tank ring Basic (-2021)	713	650207 00 02	Complete carrier	11
6602536 01 01	Minirack		516002-5	Tank ring Basic 5 hole		5052526 00 01	Center stand		650207 01 02	Rear rack	22
6302536 00 01	C-Bow holder		Our tank ring Lock-it 506015-0 / Basic 516015-0 fits all KAWASAKI models with inner mounting (-2021).			42112526 00 91	Side stand enlargement		<b>Z 440 LTD BELTDRIVE (1982-1984)</b>		
5012536 00 01	Engine guard (-2020)		506015-0	Tank ring Lock-it inner mounting		<b>GPZ 305 (1983-1987)</b>			650207 00 02	Complete carrier	11
5012519 00 01	Engine guard (2021-)		516002-5	Tank ring Basic 5 hole		650227 00 01	Complete carrier		650207 01 02	Rear rack	22
5032536 00 01	Front guard		Our tank ring Lock-it 506015-0 / Basic 516015-0 fits all KAWASAKI models with inner mounting (-2021).			650227 01 01	Rear rack	22	<b>Z 450 LTD (1985-1989)</b>		
5062536 00 01	Tank ring Lock-it (2018-2020)	900	506015-0	Tank ring Lock-it inner mounting		<b>EN 500 (1990-1995)</b>			650237 00 02	Complete carrier	71
5162536 00 01	Tank ring Basic (2018-2020)	700	516015-0	Tank ring Basic inner mounting		650256 00 02	Complete carrier		650237 01 02	Rear rack	
5062519 00 09	Tank ring Lock-it (2021)	913	Our tank ring Lock-it 506020-0 / Basic 516020-0 fits all KAWASAKI models with inner mounting (2022-).			650256 01 02	Rear rack	22	625256 00 02	Leather bag holder tube type	3:P,S
5162519 00 09	Tank ring Basic (2021)	713	506020-0	Tank ring Lock-it inner mounting		501205 00 02	Engine guard		501205 00 02	Engine guard	
5062519 01 09	Tank ring Lock-it (2022-)	919	516020-0	Tank ring Basic inner mounting		611201 00 02	Sissybar with rack	59	611201 00 02	Sissybar with rack	59
5162519 01 09	Tank ring Basic (2022-)	719	<b>ATTENTION: You can find the new 2024 models online at <a href="http://www.hepco-becker.de">www.hepco-becker.de</a></b>			600201 00 02	Sissybar without rack	59	600201 00 02	Sissybar without rack	59
42112536 00 91	Side stand enlargement										
6702536 00 01	Sportrack	52									



Item-no.	Description	Info's
<b>EN 500 (1996-2003)</b>		
650276 00 02	Complete carrier	
650276 01 02	Rear rack	22
625276 00 02	Leather bag holder tube type	3:P,S
501210 00 02	Engine guard	
611208 00 02	Sissybar with rack	59
600208 00 02	Sissybar without rack	59
400276 00 02	Twinlight Set	
<b>ER-5 (1997-2000)</b>		
650277 00 01	Complete carrier	2: A1,A2,F
650277 01 01	Rear rack	
501212 00 01	Engine guard	
506277 00 01	Tank ring Lock-it	901
<b>Notice tank rings KAWASAKI</b>		
Our tank ring Lock-it 506008-7 / Basic 516008-7 fits all KAWASAKI models with 7 hole mounting.		
506008-7	Tank ring Lock-it 7 hole	
516008-7	Tank ring Basic 7 hole	
Our tank ring Lock-it 506002-5 / Basic 516002-5 fits all KAWASAKI models with 5 hole mounting.		
506002-5	Tank ring Lock-it 5 hole	
516002-5	Tank ring Basic 5 hole	
Our tank ring Lock-it 506015-0 / Basic 516015-0 fits all KAWASAKI models with inner mounting (-2021).		
506015-0	Tank ring Lock-it inner mounting	
516015-0	Tank ring Basic inner mounting	
Our tank ring Lock-it 506020-0 / Basic 516020-0 fits all KAWASAKI models with inner mounting (2022).		
506020-0	Tank ring Lock-it inner mounting	
516020-0	Tank ring Basic inner mounting	

Item-no.	Description	Info's
<b>ER-5 (2001-2006)</b>		
650291 00 01	Complete carrier	2: A1,A2,F
650291 01 01	Rear rack	
501212 00 01	Engine guard	
503212 00 01	Front guard	
504212 00 01	Rear guard	
506291 00 01	Tank ring Lock-it	901
516291 00 01	Tank ring Basic	701
<b>GPZ 500 S (1988-1993)</b>		
650246 00 01	Complete carrier	5: A,B C,D,E,F
650246 01 01	Rear rack	22
506246 00 01	Tank ring Lock-it	906
516246 00 01	Tank ring Basic	706
<b>GPZ 500 S (1994-2003)</b>		
650201 00 01	Complete carrier	
650201 01 01	Rear rack	22
506201 00 01	Tank ring Lock-it	906
516201 00 01	Tank ring Basic	706
<b>KLE 500 (1991-2007)</b>		
650258 00 01	Side carrier	0
650258 01 01	Rear rack	9,3:B3
502200 00 01	Engine guard	
506258 00 01	Tank ring Lock-it	906
516258 00 01	Tank ring Lock-it	706
<b>Z 500 / 550 A / B (1979-1984)</b>		
650204 00 02	Complete carrier	5: A,B C,D,E,F
<b>Z 550 GT (1983-1989)</b>		
650211 00 01	Side carrier	
<b>Z 550 LTD (1980-1983)</b>		
650210 00 02	Complete carrier	
<b>Zephyr 550 (1991-1999)</b>		
650259 00 02	Complete carrier	
650259 01 02	Rear rack	22
501214 00 02	Engine guard	

Item-no.	Description	Info's
<b>ER-6f (2006-2008)</b>		
650287 00 01	Side carrier	5: A,B C,D,E,F
650287 01 01	Alurack	
661287 01 01	Easyrack	
630287 00 01	C-Bow holder	
504287 00 01	Rear guard	8
506287 00 01	Tank ring Lock-it	901
516287 00 01	Tank ring Basic	701
<b>ER-6n (2006-2008)</b>		
650287 00 01	Side carrier	5: A,B C,D,E,F
650287 01 01	Alurack	
661287 01 01	Easyrack	
630287 00 01	C-Bow holder	
501287 00 01	Engine guard	
503287 00 01	Front guard	
504287 00 01	Rear guard	8
506287 00 01	Tank ring Lock-it	901
506287 00 01	Tank ring Basic	701
<b>ER-6f (2009-2011)</b>		
6502507 00 01	Side carrier Lock-it	
6502507 01 01	Alurack	
6612507 01 01	Easyrack	
6302507 00 01	C-Bow holder	
5042507 00 01	Rear guard	
5062507 00 01	Tank ring Lock-it	901
5162507 00 01	Tank ring Basic	701
42112507 00 91	Side stand enlargement	

Item-no.	Description	Info's
<b>ER-6n (2009-2011)</b>		
6502507 00 01	Side carrier Lock-it	
6502507 01 01	Alurack	
6612507 01 01	Easyrack	
6302507 00 01	C-Bow holder	
5012507 00 01	Engine guard	
5032507 00 01	Front guard	
5042507 00 01	Rear guard	
5062507 00 01	Tank ring Lock-it	901
5162507 00 01	Tank ring Basic	701
42112507 00 91	Side stand enlargement	
<b>ER-6f (2012-2016)</b>		
6502516 00 01	Side carrier Lock-it	
6502516 01 01	Alurack	
6612516 01 01	Easyrack	
6302516 00 01	C-Bow holder	
42192516 00 01	Pillion handle bar	96
5062516 00 01	Tank ring Lock-it	901
5162516 00 01	Tank ring Basic	701
42112516 00 91	Side stand enlargement	
<b>ER-6n (2012-2016)</b>		
6502516 00 01	Side carrier Lock-it	
6502516 01 01	Alurack	
6612516 01 01	Easyrack	
6302516 00 01	C-Bow holder	
5012516 00 01	Engine guard	
5032507 00 01	Front guard	
42192516 00 01	Pillion handle bar	96
5062516 00 01	Tank ring Lock-it	901
5162516 00 01	Tank ring Basic	701
42112516 00 91	Side stand enlargement	
<b>ZX-6R (1998-2002)</b>		
506282 00 01	Tank ring Lock-it	906
516282 00 01	Tank ring Basic	706
<b>ZX-6R (2009-2012)</b>		
506204 00 01	Tank ring Lock-it	901
516204 00 01	Tank ring Basic	701

**ATTENTION: You can find the new 2024 models online at [www.hepco-becker.de](http://www.hepco-becker.de)**



Item-no.	Description	Info's
<b>ZX-6R (2019-2020)</b>		
5062540 00 09	Tank ring Lock-it (-2021)	913
5162540 00 09	Tank ring Basic (-2021)	713
42112540 00 91	Side stand enlargement	
<b>GPX 600 R (1988-1999)</b>		
650248 00 01	Complete carrier	5: A,B, C,D,E,F
650248 01 01	Rear rack	13,22
506248 00 01	Tank ring Lock-it	906
516248 00 01	Tank ring Basic	706
<b>GPZ 600 R (1985-1989)</b>		
650238 00 01	Complete carrier	5: A,B, C,D,E,F
650238 01 01	Rear rack	22
506238 00 01	Tank ring Lock-it	906
516238 00 01	Tank ring Basic	706
<b>Ninja ZX-6 R (2009-2012)</b>		
670204 00 01	Sportrack	52
<b>Ninja ZX-6 RR (2003-2006)</b>		
650202 01 01	Rear rack	
506202 00 01	Tank ring Lock-it	901
516202 00 01	Tank ring Basic	701

## Notice tank rings KAWASAKI

Our tank ring Lock-it 506008-7 / Basic 516008-7 fits all KAWASAKI models with 7 hole mounting.

506008-7	Tank ring Lock-it 7 hole
516008-7	Tank ring Basic 7 hole

Our tank ring Lock-it 506002-5 / Basic 516002-5 fits all KAWASAKI models with 5 hole mounting.

506002-5	Tank ring Lock-it 5 hole
516002-5	Tank ring Basic 5 hole

Our tank ring Lock-it 506015-0 / Basic 516015-0 fits all KAWASAKI models with inner mounting (-2021).

506015-0	Tank ring Lock-it inner mounting
516015-0	Tank ring Basic inner mounting

Our tank ring Lock-it 506020-0 / Basic 516020-0 fits all KAWASAKI models with inner mounting (2022-).

506020-0	Tank ring Lock-it inner mounting
516020-0	Tank ring Basic inner mounting

Item-no.	Description	Info's
<b>ZL 600 Eliminator (1986-1994)</b>		
650240 00 02	Complete carrier	
650240 01 02	Rear rack	22
<b>ZL 600 Eliminator (1995-1997)</b>		
650269 00 02	Side carrier	
650269 01 02	Rear rack	
611209 00 02	Sissybar with rack	59
600209 00 02	Sissybar without rack	59
<b>Ninja ZX-6 R (1995-1997)</b>		
650271 01 01	Rear rack	
506271 00 01	Tank ring Lock-it	901
516271 00 01	Tank ring Basic	701
<b>Ninja ZX-6 R (1998-2002)</b>		
650282 01 01	Rear rack	
<b>ZZ-R 600 (1990-1992)</b>		
650255 00 01	Side carrier	5: A,B, C,D,E,F
650255 01 01	Rear rack	
506255 00 01	Tank ring Lock-it	906
516255 00 01	Tank ring Basic	706
<b>ZZ-R 600 (1993-2005)</b>		
650266 00 01	Side carrier	5: A,B, C,D,E,F
650266 01 01	Rear rack	
506266 00 01	Tank ring Lock-it	901
516266 00 01	Tank ring Basic	701
<b>KLR 650 (1987-1989)</b>		
650245 00 01	Side carrier	0
650245 01 01	Rear rack	9
<b>KLR 650 (1995-2003)</b>		
650270 00 01	Side carrier	0
650270 01 01	Rear rack	9
502204 00 01	Engine guard	
<b>KLR 650 Tengai (1989-1991)</b>		
650252 00 01	Side carrier	0
650252 01 01	Rear rack	9

Item-no.	Description	Info's
<b>KLR 650 (Exportmodell) (2008-)</b>		
650206 00 01	Side carrier Lock-it	0
650206 01 01	Rear rack	9
502206 00 01	Engine guard	
810206 00 12	Skid plate	
505206 00 01	Center stand	
420206-01	Brake cylinder cover	
<b>KLX 650 (1993-2001)</b>		
650265 00 01	Side carrier	0
650265 01 01	Rear rack	9
502203 00 01	Engine guard	
<b>Ninja 650 (2017-)</b>		
6302528 00 01	C-Bow holder	
6522528 01 01	Alurack	
6612528 01 01	Easyrack	
6602528 01 01	Minirack	100
6702528 00 01	Sportrack	52
5062528 00 09	Tank ring Lock-it (-2021)	913
5162528 00 09	Tank ring Basic (-2021)	713
5062528 01 09	Tank ring Lock-it (2022-)	919
5162528 01 09	Tank ring Basic (2022-)	719
<b>Versys 650 (2007-2009)</b>		
6502505 00 01	Side carrier Lock-it	
6502505 01 01	Alurack	
6612505 01 01	Easyrack	
6302505 00 01	C-Bow holder	
501220 00 01	Engine guard	
8102510 00 91	Skid plate	
506220 00 01	Tank ring Lock-it	901
516220 00 01	Tank ring Basic	701

Item-no.	Description	Info's
<b>Versys 650 (2010-2014)</b>		
6502510 00 01	Side carrier Lock-it	
6502510 01 01	Alurack	
6612510 01 01	Easyrack	
6602510 01 01	Minirack	10,72
6302510 00 01	C-Bow holder	
5062510 00 01	Tank ring Lock-it	901
5162510 00 01	Tank ring Basic	701
5012510 00 01	Engine guard	
8102510 00 91	Skid plate	
700007460	Pillion handle bar	96
<b>Versys 650 (2015-2021)</b>		
6502522 00 01	Side carrier Lock-it	3: H
6502522 01 01	Alurack	
6612522 01 01	Easyrack	
6302522 00 01	C-Bow holder	
5012522 00 01	Engine guard	
640100 00 01	Crash bar bags V1	
7311107	LED Auxiliary headlights Nova	133
8102522 00 09	Skid plate	
5052522 00 01	Center stand	
5062522 00 01	Tank ring Lock-it	901
5162522 00 01	Tank ring Basic	701
42112522 00 91	Side stand enlargement	
<b>Versys 650 (2022-)</b>		
6502550 00 01	Side carrier Lock-it	3: H
6302550 00 01	C-Bow holder	
6522550 01 01	Alurack	
6612550 01 01	Easyrack	
5062550 00 09	Tank ring Lock-it	919
5162550 00 09	Tank ring Basic	719
5012550 00 01	Engine guard	
640100 00 01	Crash bar bag set V1	
5052550 00 01	Center stand	
42112550 00 91	Side stand enlargement	
7311106	Auxiliary headlights	133



**ATTENTION: You can find the new 2024 models online at [www.hepco-becker.de](http://www.hepco-becker.de)**



Item-no.	Description	Info's
<b>Vulcan S (2015-)</b>		
6502524 01 01	Rear rack	
6302524 00 01	C-Bow holder	178
5012524 00 01	Engine guard (-2016)	194
5012531 00 01	Engine guard (2017-)	
6112524 00 01	Sissybar with rack	
6002524 00 01	Sissybar without rack	
6112523 00 01	Solorack with pad	
6002523 00 01	Solorack without pad	
5062524 00 01	Tank ring Lock-it	901
5162524 00 01	Tank ring Basic	701

Item-no.	Description	Info's
<b>W 650 (1999-2006)</b>		
650284 00 01	Complete carrier	
650284 00 02	Complete carrier	
650284 01 01	Rear rack	105,106
650284 01 02	Rear rack	105,106
650286 01 01	Rear rack	72,105
650286 01 02	Rear rack	72,105
630284 00 01	C-Bow leather bag holder	109
630284 00 02	C-Bow leather bag holder	109
501217 00 01	Engine guard	
501217 00 02	Engine guard	

Item-no.	Description	Info's
<b>Z 650 (2017-)</b>		
6302527 00 01	C-Bow holder	
6522527 01 01	Alurack	
6612527 01 01	Easyrack	
6602527 01 01	Minirack	100
5012527 00 01	Engine guard incl. Protectionpad	
5032527 00 01	Front guard (-2019)	
5032545 00 01	Front guard (2020-)	
5042527 00 01	Rear guard	
6702527 00 01	Sportrack	52
42112527 00 91	Side stand enlargement	
5062527 00 09	Tank ring Lock-it (-2021)	913
5162527 00 09	Tank ring Basic (-2021)	713
5062527 01 09	Tank ring Lock-it (2022-)	919
5162527 01 09	Tank ring Basic (2022-)	719

Item-no.	Description	Info's
<b>Z 650 RS (2022-)</b>		
6302549 00 01	C-Bow holder	
6522549 01 01	Alurack	
6612549 01 01	Easyrack	
6602549 01 01	Minirack	
6582549 01 01	Rear rack tube type	
5032549 00 01	Front guard	
5042549 00 01	Rear guard	
42192549 00 01	Pillion handle	
5012549 00 01	Engie guard	
5062549 00 09	Tank ring Lock-it	919
5162549 00 09	Tank ring Basic	719
42112549 00 91	Side stand enlargement	

Item-no.	Description	Info's
<b>Z 650 A / B / C / F (1977-1979)</b>		
650212 00 02	Complete carrier	

Item-no.	Description	Info's
<b>Z 650 SR (1979-1980)</b>		
650213 00 02	Complete carrier	

Item-no.	Description	Info's
<b>ZR 7 (1999-2003) / ZR 7 S (2001-2003)</b>		
650283 00 01	Side carrier	
650283 01 01	Rear rack	
501216 00 02	Engine guard	
506283 00 01	Tank ring Lock-it	906
516283 00 01	Tank ring Basic	706

Item-no.	Description	Info's
<b>ZX-7 R Ninja (1996-2002)</b>		
650229 00 01	Side carrier	32
650229 01 01	Rear rack	
506229 00 01	Tank ring Lock-it	901
516229 00 01	Tank ring Basic	701

Item-no.	Description	Info's
<b>GPX 750 R (1987-1988)</b>		
650244 00 01	Side carrier	5: A,B, C,D,E,F
650244 01 01	Rear rack	
506244 00 01	Tank ring Lock-it	906
516244 00 01	Tank ring Basic	706

Item-no.	Description	Info's
<b>GPZ 750 (1985-1986)</b>		
650231 00 01	Complete carrier	21, 2: A1,A2,F
650231 01 01	Rear rack	22
506231 00 01	Tank ring Lock-it	906
516231 00 01	Tank ring Basic	706

Item-no.	Description	Info's
<b>VN 750 Twin (1986-1992)</b>		
650239 00 02	Complete carrier	
650239 01 02	Rear rack	22
625239 00 02	Leather bag holder tube type	
611205 00 02	Sissybar with rack	59

Item-no.	Description	Info's
<b>Z 750 LTD Twin (1976-1979)</b>		
650205 00 02	Complete carrier	11

Item-no.	Description	Info's
<b>Z 750 LTD Four (1980-1982)</b>		
650216 00 02	Complete carrier	11

Item-no.	Description	Info's
<b>ZX 750 GP (1983-1984)</b>		
650215 00 01	Complete carrier	
650215 01 01	Rear rack	27

Item-no.	Description	Info's
<b>Z 750 GT (1982-1985)</b>		
650211 00 01	Side carrier	

Item-no.	Description	Info's
<b>ZXR 750 (1991-1994)</b>		
650260 00 01	Complete carrier	5: A,B, C,D,E,F
650260 01 01	Rear rack	27
506260 00 01	Tank ring Lock-it	906
516260 00 01	Tank ring Basic	706

Item-no.	Description	Info's
<b>Z 750 (2004-2006)</b>		
650297 00 01	Side carrier	
650297 01 01	Rear rack	32
506297 00 01	Tank ring Lock-it	901
516297 00 01	Tank ring Basic	701

Item-no.	Description	Info's
<b>Z 750 S (2005-2006)</b>		
650262 00 01	Side carrier	
650262 01 01	Rear rack	
506262 00 01	Tank ring Lock-it	901
516262 00 01	Tank ring Basic	701

## Notice tank rings KAWASAKI

Our tank ring Lock-it 506008-7 / Basic 516008-7 fits all KAWASAKI models with 7 hole mounting.

506008-7	Tank ring Lock-it 7 hole
516008-7	Tank ring Basic 7 hole

Our tank ring Lock-it 506002-5 / Basic 516002-5 fits all KAWASAKI models with 5 hole mounting.

506002-5	Tank ring Lock-it 5 hole
516002-5	Tank ring Basic 5 hole

Our tank ring Lock-it 506015-0 / Basic 516015-0 fits all KAWASAKI models with inner mounting (-2021).

506015-0	Tank ring Lock-it inner mounting
516015-0	Tank ring Basic inner mounting

Our tank ring Lock-it 506020-0 / Basic 516020-0 fits all KAWASAKI models with inner mounting (2022-).

506020-0	Tank ring Lock-it inner mounting
516020-0	Tank ring Basic inner mounting

**ATTENTION: You can find the new 2024 models online at [www.hepco-becker.de](http://www.hepco-becker.de)**



Info reference see p. 271

The last digit of the item-no. refers to the colours: 01= black 02= chrome 03= white 04= red 05= anthracite 06= orange 08= yellow 09= silver 10= blue metallic 12= Alu brushed 22= Stainless steel 91= silver/black

Item-no.	Description	Info's
<b>Z 750 (2007-2012)</b>		
670262 00 01	Sportrack	52
630262 00 01	C-Bow holder	
506262 00 01	Tank ring Lock-it	901
516262 00 01	Tank ring Basic	701
<b>Z 750 R (2007-2012)</b>		
670262 00 01	Sportrack	52
506262 00 01	Tank ring Lock-it	901
516262 00 01	Tank ring Basic	701
<b>Zephyr 750 (1991-1999)</b>		
650261 00 02	Complete carrier	
650261 01 02	Rear rack	22
501203 00 02	Engine guard	
506261 00 01	Tank ring Lock-it	906
516261 00 01	Tank ring Basic	706
<b>VN 800 (1995-2000)</b>		
650273 00 02	Complete carrier	
650273 01 02	Rear rack	22
625273 00 02	Leather bag holder tube type	3:P,S
501208 00 02	Engine guard	
611204 00 02	Sissybar with rack	59
600204 00 02	Sissybar without rack	59
400273 00 02	Twinlight Set	
<b>VN 800 Drifter (1999-2003)</b>		
625286 00 01	Leather bag holder tube type	
611213 00 01	Sissybar with rack	59,62
600213 00 01	Sissybar without rack	59,62
<b>VN 800 Classic (1996-1999)</b>		
650275 00 02	Complete carrier	
650275 01 02	Rear rack	22
625275 00 02	Leather bag holder tube type	3:P,S
501211 00 02	Engine guard	
611207 00 02	Sissybar with rack	59
600207 00 02	Sissybar without rack	59
400275 00 02	Twinlight Set	

Item-no.	Description	Info's
<b>VN 800 Classic (2000-2005)</b>		
650289 00 02	Side carrier	
650289 01 02	Rear rack	
625275 00 02	Leather bag holder tube type	3:P,S
501211 00 02	Engine guard	
611289 00 02	Sissybar with rack	59
600289 00 02	Sissybar without rack	59
400289 00 02	Twinlight Set	

### Notice tank rings KAWASAKI

Our tank ring Lock-it 506008-7 / Basic 516008-7 fits all KAWASAKI models with 7 hole mounting.

506008-7	Tank ring Lock-it 7 hole
516008-7	Tank ring Basic 7 hole

Our tank ring Lock-it 506002-5 / Basic 516002-5 fits all KAWASAKI models with 5 hole mounting.

506002-5	Tank ring Lock-it 5 hole
516002-5	Tank ring Basic 5 hole

Our tank ring Lock-it 506015-0 / Basic 516015-0 fits all KAWASAKI models with inner mounting (-2021).

506015-0	Tank ring Lock-it inner mounting
516015-0	Tank ring Basic inner mounting

Our tank ring Lock-it 506020-0 / Basic 516020-0 fits all KAWASAKI models with inner mounting (2022-).

506020-0	Tank ring Lock-it inner mounting
516020-0	Tank ring Basic inner mounting

Item-no.	Description	Info's
<b>W 800 (2011-2016)</b>		
650284 00 01	Complete carrier	
650284 00 02	Complete carrier	
650284 01 01	Rear rack	105,106
650284 01 02	Rear rack	105,106
650286 01 01	Rear rack	72,105
650286 01 02	Rear rack	72,105
630284 00 01	C-Bow leather bag holder	131
630284 00 02	C-Bow leather bag holder	131
501217 00 01	Engine guard	
501217 00 02	Engine guard	
<b>W 800 Street / Café (2019-)</b>		
6502541 00 01	Complete carrier	174
6502541 00 02	Complete carrier	174
6302541 00 01	C-Bow holder	
6302541 00 02	C-Bow holder	
6582541 01 01	Rear rack tube type	141,105
6582541 01 02	Rear rack tube type	141,105
6542541 01 01	Rear rack tube type	105,106
6542541 01 02	Rear rack tube type	105,106
5012541 00 01	Engine guard	
5012541 00 02	Engine guard	
42152541 00 01	Pillion footrest lowering kit	50,168
42192541 00 01	Pillion handle bar / Railing	
<b>Z 800 / E Version (2013-2016)</b>		
6502518 00 01	Side carrier Lock-it	
6502518 01 01	Alurack	
6612518 01 01	Easyrack	
6302518 00 01	C-Bow holder	
6702518 00 01	Sportrack	52
5012518 00 01	Engine guard	
5062518 00 01	Tank ring Lock-it	901
5162518 00 01	Tank ring Basic	701

Item-no.	Description	Info's
<b>GPZ 900 R (1984-1993)</b>		
650231 00 01	Complete carrier	21, 2: A1,A2,F
650231 01 01	Rear rack	22
<b>VN 900 Classic (2006-) / Vulcan</b>		
6502501 00 01	Side carrier	
6502501 00 02	Side carrier	
6502501 01 01	Rear rack	
6302501 00 01	C-Bow leather bag holder	
6302501 00 02	C-Bow leather bag holder	
6252501 00 02	Leather bag holder tube type	
6252501 00 01	Leather bag holder tube type	
501219 00 01	Engine guard	
501219 00 02	Engine guard	
611217 00 01	Sissybar with rack	59
611217 00 02	Sissybar with rack	59
600217 00 01	Sissybar without rack	59
600217 00 02	Sissybar without rack	59
4002501 00 01	Twinlight Set	
4002501 00 02	Twinlight Set	
<b>VN 900 Custom / Vulcan (2006-)</b>		
6502501 00 01	Side carrier	
6502501 00 02	Side carrier	
6502501 01 01	Rear rack	
6502501 01 02	Rear rack	
6302501 00 01	C-Bow leather bag holder	
6302501 00 02	C-Bow leather bag holder	
6252501 00 02	Leather bag holder tube type	
6252501 00 01	Leather bag holder tube type	
501221 00 01	Engine guard	
501221 00 02	Engine guard	
611217 00 01	Sissybar with rack	59
611217 00 02	Sissybar with rack	59
600217 00 01	Sissybar without rack	59
600217 00 02	Sissybar without rack	59
4002502 00 02	Twinlight Set	

**ATTENTION: You can find the new 2024 models online at [www.hepco-becker.de](http://www.hepco-becker.de)**





Item-no.	Description	Info's
<b>Z 900 (1973-1976)</b>		
6502535 00 02	Complete carrier	161
6542535 01 02	Rear rack	22
6502535 01 02	Rear rack	66
6532535 00 02	Side carrier	64,161
5012535 00 02	Engine guard	
<b>Z 900 (2017-) / SE (2022-)</b>		
6302529 00 01	C-Bow holder (Not for SE)	213
6702529 00 01	Sportrack	52
5062529 00 09	Tank ring Lock-it (-2021)	913
5162529 00 09	Tank ring Basic (-2021)	713
5062529 01 09	Tank ring Lock-it (2022-)	919
5162529 01 09	Tank ring Basic (2022-)	719
42112529 00 91	Side stand enlargement	
5012529 00 01	Engine guard incl. Protectionpad	

## Notice tank rings KAWASAKI

Our tank ring Lock-it 506008-7 / Basic 516008-7 fits all KAWASAKI models with 7 hole mounting.

506008-7	Tank ring Lock-it 7 hole
516008-7	Tank ring Basic 7 hole

Our tank ring Lock-it 506002-5 / Basic 516002-5 fits all KAWASAKI models with 5 hole mounting.

506002-5	Tank ring Lock-it 5 hole
516002-5	Tank ring Basic 5 hole

Our tank ring Lock-it 506015-0 / Basic 516015-0 fits all KAWASAKI models with inner mounting (-2021).

506015-0	Tank ring Lock-it inner mounting
516015-0	Tank ring Basic inner mounting

Our tank ring Lock-it 506020-0 / Basic 516020-0 fits all KAWASAKI models with inner mounting (2022-).

506020-0	Tank ring Lock-it inner mounting
516020-0	Tank ring Basic inner mounting

Item-no.	Description	Info's
<b>Z 900 RS / Cafe (2018-) / SE (2022-)</b>		
6302533 00 01	C-Bow holder (Not for SE)	161,213
6502533 00 01	Side carrier Lock-it (Not for SE)	91,213, 3,H
6522533 01 01	Alurack	
6612533 01 01	Easyrack	
6602533 01 01	Minirack	
6542533 01 01	Rear rack tube type	141
5062533 00 01	Tank ring Lock-it	901
5162533 00 01	Tank ring Basic	701
5012533 00 01	Engine guard	
5052533 00 01	Center stand	
42112533 00 91	Side stand enlargement	
42192533 00 01	Railing / Pillion handle bar	96
42192533 00 02	Railing / Pillion handle bar	96

## ZX-9 R Ninja (1994-1997)

650267 00 01	Side carrier	
650267 01 01	Rear rack	13
506267 00 01	Tank ring Lock-it	906
516267 00 01	Tank ring Basic	706

## ZX-9 R Ninja (1998-2001)

650281 01 01	Rear rack	
506281 00 01	Tank ring Lock-it	906
516281 00 01	Tank ring Basic	706

## ZX-9 R Ninja (2002-2003)

650292 01 01	Rear rack	
506292 00 01	Tank ring Lock-it	906
516292 00 01	Tank ring Basic	706

## Ninja H2 SX (2018-)

5062534 00 01	Tank ring Lock-it	901
5162534 00 01	Tank ring Basic	701

Item-no.	Description	Info's
<b>Z H2 (2020-)</b>		
6702543 00 01	Sportrack	52
6302543 00 01	C-Bow holder	111
5062543 00 09	Tank ring Lock-it (-2021)	913
5162543 00 09	Tank ring Basic (-2021)	713
5062543 01 09	Tank ring Lock-it (2022-)	919
5162543 01 09	Tank ring Basic (2022-)	719
42112543 00 91	Side stand enlargement	

## GPZ 1000 RX (1986-1987)

650241 00 01	Side carrier	5: A,B, C,D,E,F
650241 01 01	Rear rack	
506241 00 01	Tank ring Lock-it	906
516241 00 01	Tank ring Basic	706

## GTR 1000 (1986-2003)

650242 00 01	Complete carrier	2: A1,A2,F
650242 01 01	Rear rack	22
506242 00 01	Tank ring Lock-it	906
516242 00 01	Tank ring Basic	706

## KLX 1000 (2004-2005)

650299 00 01	Side carrier Lock-it	
650299 01 01	Alurack	9
661299 01 01	Easyrack	9
800299 00 09	Rear rack enlargement	

## Ninja 1000 SX (2020-)

502205 00 01	Engine guard	
505299 00 01	Center stand	
506299 00 01	Tank ring Lock-it	907
516299 00 01	Tank ring Basic	707
5062544 00 09	Tank ring Lock-it (-2021)	913
5162544 00 09	Tank ring Basic (-2021)	713
5062544 01 09	Tank ring Lock-it (2022-)	919
5162544 01 09	Tank ring Basic (2022-)	719
6702544 00 01	Sportrack	
42112544 00 91	Side stand enlargement	

Item-no.	Description	Info's
<b>Versys 1000 (2012-2014)</b>		
6502515 00 01	Side carrier Lock-it	
6502515 01 01	Alurack	9
6612515 01 01	Easyrack	9
6302515 00 01	C-Bow holder	
5012515 00 01	Engine guard	
8102515 00 12	Skid plate	
5052515 00 01	Center stand	
8002515 00 01	Rear rack enlargement	
42112515 00 91	Side stand enlargement	
5062515 00 01	Tank ring Lock-it	901
5162515 00 01	Tank ring Basic	701
4202515-01	Pillion handle instead of original rack	96
<b>Versys 1000 (2015-2018)</b>		
6502523 00 01	Side carrier Lock-it	
6502523 01 01	Alurack	
6612523 01 01	Easyrack	
6302523 00 01	C-Bow holder	
5012523 00 01	Engine guard incl. Protectionpad	
7311107	LED Auxiliary headlights Nova	133
8102523 00 09	Skid plate	
8002523 00 01	Rear rack enlargement	
42112523 00 91	Side stand enlargement	
5062523 00 01	Tank ring Lock-it	901
5162523 00 01	Tank ring Basic	701



**ATTENTION: You can find the new 2024 models online at [www.hepco-becker.de](http://www.hepco-becker.de)**



Info reference see p. 271

The last digit of the item-no. refers to the colours: 01= black 02= chrome 03= white 04= red 05= anthracite 06= orange 08= yellow 09= silver 10= blue metallic 12= Alu brushed 22= Stainless steel 91= silver/black

Item-no.	Description	Info's
<b>Versys 1000 S / SE (2019-)</b>		
6502539 00 01	Side carrier Lock-it	
6552539 01 01	Alurack f. Original rack	
6622539 01 01	Easyrack f. Original rack	
5012539 00 01	Engine guard incl. Protectionpad	44
42112539 00 91	Side stand enlargement	
5062539 00 09	Tank ring Lock-it (-2021)	913
5162539 00 09	Tank ring Basic (-2021)	713
5062539 01 09	Tank ring Lock-it (2022-)	919
5162539 01 09	Tank ring Basic (2022-)	719
731107	LED Auxiliary headlights Nova	133
<b>Z 1000 J / R (1981-1983)</b>		
650217 00 01	Complete carrier	5: A,B,C,D,E,F
650217 01 01	Rear rack	22
<b>Z 1000 A (1977-1978)</b>		
6502535 00 02	Complete carrier	161
6542535 01 02	Rear rack	22
6502535 01 02	Rear rack	66
6532535 00 02	Side carrier	64,161
5012535 00 02	Engine guard	
<b>Z 1000 MK II (1979-1980)</b>		
650221 00 02	Complete carrier	
<b>Z 1000 ST (1979-1980)</b>		
650222 00 02	Complete carrier	
<b>ZL 1000 (1987-1988)</b>		
650247 00 02	Complete carrier	
<b>Z 1000 (2003-2006)</b>		
650296 00 01	Side carrier	32
650296 01 01	Rear rack	
506296 00 01	Tank ring Lock-it	901
516296 00 01	Tank ring Basic	701
<b>Z 1000 (2008-2009)</b>		
630296 00 01	C-Bow holder	
670296 00 01	Sportrack	52
506296 00 01	Tank ring Lock-it	901
516296 00 01	Tank ring Basic	701

Item-no.	Description	Info's
<b>Z 1000 (2010-2013)</b>		
670201 00 01	Sportrack	52
506296 00 01	Tank ring Lock-it	901
516296 00 01	Tank ring Basic	701
<b>Z 1000 (2014-2020)</b>		
630209 00 01	C-Bow holder	
506209 00 01	Tank ring Lock-it	901
516209 00 01	Tank ring Basic	701
670209 00 01	Sportrack	113,52
<b>Z 1000 SX (2011-2014)</b>		
6502514 00 01	Side carrier Lock-it	
6502514 01 01	Alurack	68,106
6612514 01 01	Easyrack	68,106
6302514 00 01	C-Bow holder	96
710128	Screw kit for combination of C-Bow + Alurack	
6702514 00 01	Sportrack (-2013)	52
6702515 00 01	Sportrack (2014-)	52
5062514 00 01	Tank ring Lock-it	901
5162514 00 01	Tank ring Basic	701
<b>Z 1000 SX (2015-2016)</b>		
6502525 00 01	Side carrier Lock-it	
6522525 01 01	Alurack	68,106
6612525 01 01	Easyrack	68,106
6302525 00 01	C-Bow holder	96
6702525 00 01	Sportrack	52
5062525 00 01	Tank ring Lock-it	901
5162525 00 01	Tank ring Basic	701
42112525 00 91	Side stand enlargement	

Item-no.	Description	Info's
<b>Z 1000 SX (2017-)</b>		
6302530 00 01	C-Bow holder	96
6522530 01 01	Alurack	68,106
6612530 01 01	Easyrack	68,106
5062530 00 01	Tank ring Lock-it	901
5162530 00 01	Tank ring Basic	701
42112530 00 91	Side stand enlargement	
6702530 00 01	Sportrack	52
<b>ZX-10 (1988-1990)</b>		
650249 00 01	Side carrier	5: A, B, C, D, E, F
650249 01 01	Rear rack	
506203 00 01	Tank ring Lock-it	901
516203 00 01	Tank ring Basic	701
<b>ZX-10 R Ninja (2008-2010)</b>		
670203 00 01	Sportrack	52
506203 00 01	Tank ring Lock-it	901
516203 00 01	Tank ring Basic	701
<b>ZX-10 R Ninja (2011-2015)</b>		
670205 00 01	Sportrack	52
506205 00 01	Tank ring Lock-it	901
516205 00 01	Tank ring Basic	701
<b>ZX-10 R Ninja (2021-)</b>		
5062546 00 09	Tank ring Lock-it (2022-)	919
5162546 00 09	Tank ring Basic (2022-)	719
<b>Z 1100 GP Unitrack (1983-1984)</b>		
650225 00 01	Complete carrier	
650225 01 01	Rear rack	22
<b>ZZ-R 1100 (1990-1992)</b>		
650254 00 01	Side carrier	
650254 01 01	Rear rack	141
506254 00 01	Tank ring Lock-it	906
516254 00 01	Tank ring Basic	706
<b>Z 1100 GPZ (1981-1985)</b>		
650217 00 01	Complete carrier	5: A, B, C, D, E, F
650217 01 01	Rear rack	22

Item-no.	Description	Info's
<b>ZZ-R 1100 (1993-2001)</b>		
650264 00 01	Side carrier	
650264 01 01	Rear rack	
506264 00 01	Tank ring Lock-it	901
516264 00 01	Tank ring Basic	701
<b>GPZ 1100 / ABS (1996-1997)</b>		
650272 00 01	Complete carrier	
650272 01 01	Rear rack	22
506272 00 01	Tank ring Lock-it	906
516272 00 01	Tank ring Basic	706
<b>Z 1100 Spectre (1982-1983)</b>		
650226 00 02	Complete carrier	
<b>Zephyr 1100 (1992-1998)</b>		
650263 00 02	Complete carrier	
650263 01 02	Rear rack	22
501204 00 02	Engine guard	

### Notice tank rings KAWASAKI

Our tank ring Lock-it 506008-7 / Basic 516008-7 fits all KAWASAKI models with 7 hole mounting.

506008-7	Tank ring Lock-it 7 hole
516008-7	Tank ring Basic 7 hole

Our tank ring Lock-it 506002-5 / Basic 516002-5 fits all KAWASAKI models with 5 hole mounting.

506002-5	Tank ring Lock-it 5 hole
516002-5	Tank ring Basic 5 hole

Our tank ring Lock-it 506015-0 / Basic 516015-0 fits all KAWASAKI models with inner mounting (-2021).

506015-0	Tank ring Lock-it inner mounting
516015-0	Tank ring Basic inner mounting

Our tank ring Lock-it 506020-0 / Basic 516020-0 fits all KAWASAKI models with inner mounting (2022-).

506020-0	Tank ring Lock-it inner mounting
516020-0	Tank ring Basic inner mounting

**ATTENTION: You can find the new 2024 models online at [www.hepco-becker.de](http://www.hepco-becker.de)**



Item-no.	Description	Info's
<b>ZRX 1100 (1997-2001)</b>		
650278 00 01	Side carrier	30
650278 01 01	Rear rack	
501213 00 02	Engine guard	
506278 00 01	Tank ring Lock-it	906
516278 00 01	Tank ring Basic	706
<b>ZX 1100</b>		
650225 00 01	Complete carrier	
650225 01 01	Rear rack	22
<b>ZX-12 R (2000-2006)</b>		
650288 01 01	Rear rack	
506288 00 01	Tank ring Lock-it	906
516288 00 01	Tank ring Basic	706
<b>ZRX 1200 R / S (2001-2007)</b>		
650290 00 01	Side carrier	30
650290 01 01	Rear rack	
501290 00 02	Engine guard	
506290 00 01	Tank ring Lock-it	901
516290 00 01	Tank ring Basic	701
<b>ZZR 1200 (2002-2005)</b>		
650294 00 01	Side carrier	
650294 01 01	Rear rack	
506294 00 01	Tank ring Lock-it	901
516294 00 01	Tank ring Basic	701
<b>Z 1300 (1979-1989)</b>		
650224 00 02	Complete carrier	
501201 00 02	Engine guard	
<b>GTR 1400 (2007-2016)</b>		
6502506 01 01	Alurack	
6612506 01 01	Easyrack	
5062506 00 01	Tank ring Lock-it	901
5162506 00 01	Tank ring Basic	701
<b>ZZ-R 1400 (2006-2011)</b>		
6502502 00 01	Side carrier Lock-it	99, 3:C,D
6502502 01 01	Alurack	
6612502 01 01	Easyrack	
5062502 00 01	Tank ring Lock-it	901
5162502 00 01	Tank ring Basic	701

Item-no.	Description	Info's
<b>ZZ-R 1400 (2012-2020)</b>		
6502517 00 01	Side carrier Lock-it (-2016)	99, 3:C,D
6502517 01 01	Alurack	
6612517 01 01	Easyrack	
5062517 00 01	Tank ring Lock-it	901
5162517 00 01	Tank ring Basic	701
<b>VN 1500 Classic (1996-2002)</b>		
650274 00 02	Complete carrier	8
650274 01 02	Rear rack	
625274 00 02	Leather bag holder tube type	
501209 00 02	Engine guard	
611206 00 02	Sissybar with rack	59
600206 00 02	Sissybar without rack	59
611210 00 02	Solorack with pad	59
600210 00 02	Solorack without pad	59
400274 00 02	Twinlight Set	
<b>VN 1500 Classic Tourer (1998-2003)</b>		
650285 01 02	Rear rack	
611211 00 02	Sissybar with rack	59
600211 00 02	Sissybar without rack	59
<b>VN 1500 Mean Streak (2002-2003)</b>		
650293 00 02	Side carrier	
650293 01 02	Rear rack	
625293 00 02	Leather bag holder tube type	
501218 00 02	Engine guard	
611293 00 02	Sissybar with rack	59
600293 00 02	Sissybar without rack	59
400293 00 02	Twinlight Set	
<b>VN 1500</b>		
650257 00 02	Complete carrier	8,38
650257 01 02	Rear rack	22
625257 00 02	Leather bag holder tube type	
501207 00 02	Engine guard	
611202 00 02	Sissybar with rack	59
600202 00 02	Sissybar without rack	59

Item-no.	Description	Info's
<b>VN 1500 Drifter (1999-2003)</b>		
625287 00 01	Leather bag holder tube type	
611214 00 01	Sissybar with rack	59,62
600214 00 01	Sissybar without rack	59,62
<b>VN 1500 (1994-)</b>		
650268 00 02	Complete carrier	8,40
650268 01 02	Rear rack	22
625257 00 02	Leather bag holder tube type	
501207 00 02	Engine guard	
611202 00 02	Sissybar with rack	59
600202 00 02	Sissybar without rack	59
<b>VN 1500/SE (-1993)</b>		
650250 00 02	Complete carrier	40
650250 01 02	Rear rack	22
625257 00 02	Leather bag holder tube type	
501207 00 02	Engine guard	
611202 00 02	Sissybar with rack	59
600202 00 02	Sissybar without rack	59
<b>VN 1600 Classic (2003-2008)</b>		
650295 00 02	Side carrier	
650295 01 02	Rear rack	
625295 00 02	Leather bag holder tube type	
501295 00 02	Engine guard	
611295 00 02	Sissybar with rack	59
600295 00 02	Sissybar without rack	59
611215 00 02	Solorack with pad	59
600215 00 02	Solorack without pad	59
400295 00 02	Twinlight Set	
410295 00 02	Fender Guard	
<b>VN 1600 Classic Tourer (2005-2008)</b>		
400296 00 02	Twinlight Set	

Item-no.	Description	Info's
<b>VN 1600 Mean Streak (2004-2008)</b>		
650293 00 02	Side carrier	
650293 01 02	Rear rack	
625293 00 02	Leather bag holder tube type	
501218 00 02	Engine guard	
611293 00 02	Sissybar with rack	59
600293 00 02	Sissybar without rack	59
400293 00 02	Twinlight Set	
<b>VN 1700 Classic (2009-2014)</b>		
650234 00 02	Side carrier	
650234 01 02	Rear rack	
630234 00 02	C-Bow leather bag holder	102
501234 00 02	Engine guard	
611234 00 02	Sissybar with rack	59
600234 00 02	Sissybar without rack	59
400234 00 02	Twinlight Set	

### Notice tank rings KAWASAKI

Our tank ring Lock-it 506008-7 / Basic 516008-7 fits all KAWASAKI models with 7 hole mounting.

506008-7	Tank ring Lock-it 7 hole
516008-7	Tank ring Basic 7 hole

Our tank ring Lock-it 506002-5 / Basic 516002-5 fits all KAWASAKI models with 5 hole mounting.

506002-5	Tank ring Lock-it 5 hole
516002-5	Tank ring Basic 5 hole

Our tank ring Lock-it 506015-0 / Basic 516015-0 fits all KAWASAKI models with inner mounting (-2021).

506015-0	Tank ring Lock-it inner mounting
516015-0	Tank ring Basic inner mounting

Our tank ring Lock-it 506020-0 / Basic 516020-0 fits all KAWASAKI models with inner mounting (2022-).

506020-0	Tank ring Lock-it inner mounting
516020-0	Tank ring Basic inner mounting



**ATTENTION: You can find the new 2024 models online at [www.hepco-becker.de](http://www.hepco-becker.de)**

Item-no. Description Info's

## VN 2000 (2004-2010)

650298 00 02	Side carrier	
625298 00 02	Leather bag holder tube type	
501298 00 02	Engine guard	
611298 00 02	Sissybar with rack	59
600298 00 02	Sissybar without rack	59
611216 00 02	Solorack with pad	59
600216 00 02	Solorack without pad	59
410298 00 02	Fender Guard	

## Notice tank rings KAWASAKI

Our tank ring Lock-it 506008-7 / Basic 516008-7 fits all KAWASAKI models with 7 hole mounting.

506008-7 Tank ring Lock-it 7 hole

516008-7 Tank ring Basic 7 hole

Our tank ring Lock-it 506002-5 / Basic 516002-5 fits all KAWASAKI models with 5 hole mounting.

506002-5 Tank ring Lock-it 5 hole

516002-5 Tank ring Basic 5 hole

Our tank ring Lock-it 506015-0 / Basic 516015-0 fits all KAWASAKI models with inner mounting (-2021).

506015-0 Tank ring Lock-it inner mounting

516015-0 Tank ring Basic inner mounting

Our tank ring Lock-it 506020-0 / Basic 516020-0 fits all KAWASAKI models with inner mounting (2022-).

506020-0 Tank ring Lock-it inner mounting

516020-0 Tank ring Basic inner mounting



**ATTENTION: You can find the new 2024 models online at [www.hepco-becker.de](http://www.hepco-becker.de)**



Item-no.	Description	Info's	Item-no.	Description	Info's	Item-no.	Description	Info's	Item-no.	Description	Info's
<b>125 Duke (2011-2016)</b>			<b>390 Duke (2013-2016)</b>			<b>390 Adventure (2020-)</b>			<b>690 Duke / R (2012-)</b>		
6507504 00 01	Side carrier		6507518 00 01	Side carrier		6537601 00 01	Side carrier	3:H	6507510 01 01	Alurack	
6507504 01 01	Alurack		6507518 01 01	Alurack		6307601 00 01	C-Bow holder		6617510 01 01	Easyrack	
6617504 01 01	Easyrack		6617518 01 01	Easyrack		6527601 01 01	Alurack		6307510 00 01	C-Bow holder	
6307504 00 01	C-Bow holder	111	6307518 00 01	C-Bow holder	111	6617601 01 01	Easyrack		6707510 00 01	Sportrack (-2015)	52
5017504 00 01	Engine guard		5017518 00 06	Engine guard		6607601 01 01	Minirack		6707511 00 01	Sportrack (2016-)	52
5067504 00 01	Tank ring Lock-it (-2013)	909	5067518 00 01	Tank ring Lock-it (-2013)	909	8007601 00 01	Rear rack enlargement		5017510 00 06	Engine guard incl. Protectionpad (-2015)	
5067504 01 01	Tank ring Lock-it (2014-2016)	900	5067517 00 01	Tank ring Lock-it (2014-2016)	900	5067601 00 01	Tank ring Lock-it		7007510 00 01	Headlight grilles	112
5167504 00 01	Tank ring Basic (-2013)	709	5167518 00 01	Tank ring Basic (-2013)	709	5167601 00 01	Tank ring Basic		5067510 00 01	Tank ring Lock-it (2012-2013)	909
5167504 01 01	Tank ring Basic (2014-2016)	700	5167517 00 01	Tank ring Basic (2014-2016)	700	5017601 00 01	Engine guard		5067511 00 01	Tank ring Lock-it (2014-)	900
<b>125 Duke (2017-)</b>			<b>390 Duke (2017-)</b>			<b>LC 4 400 (1997-)</b>			<b>790 Duke (2018-)</b>		
6307554 00 01	C-Bow holder		6307555 00 01	C-Bow holder		650751 00 01	Side carrier	0	6317569 00 01L	C-Bow holder, one-sided left	
6707554 00 01	Sportrack	52	6707555 00 01	Sportrack	52	<b>LC4-E 400 (1999-2004)</b>			6527569 01 01	Alurack	156
5067554 00 01	Tank ring Lock-it	914	5067555 00 01	Tank ring Lock-it	914	650769 00 01	Side carrier	0	6617569 01 01	Easyrack	156
5167554 00 01	Tank ring Basic	714	5167555 00 01	Tank ring Basic	714	650769 01 01	Rear rack		6607569 01 01	Minirack	156
6527554 01 01	Alurack		6527555 01 01	Alurack		<b>LC 4 620 (1994-1996)</b>			5067569 00 01	Tank ring Lock-it	914, 4: L1, L2, M1, M2
6617554 01 01	Easyrack		6617555 01 01	Easyrack		650751 00 01	Side carrier	0	5167569 00 01	Tank ring Basic	714, 4: L1, L2, M1, M2
6607554 01 01	Minirack		6607555 01 01	Minirack		<b>LC 4 R 620 (1998)</b>			5017569 00 01	Engine guard incl. Protectionpad	
5017554 00 01	Engine guard (-2020)		5017555 00 06	Engine guard (-2020)		650751 00 01	Side carrier	0	5017569 00 06	Engine guard incl. Protectionpad	
5017554 00 06	Engine guard (-2020)		5017631 00 01	Engine guard (2021-)		<b>LC 4 E 640 (1998-)</b>			6707569 00 01	Sportrack	52
5017630 00 01	Engine guard (2021-)		5017631 00 06	Engine guard (2021-)		650769 00 01	Side carrier	0	42247569 00 91	Heat shield	
5017630 00 06	Engine guard (2021-)		42117555 00 91	Side stand enlargement		650769 01 01	Rear rack		<b>LC 4 Adventure (1998-2003)</b>		
42117554 00 91	Side stand enlargement		<b>NOTICE Tank rings KTM</b>			650769 00 01	Side carrier	0	650769 00 01	Side carrier	0
<b>200 Duke (2012-2013)</b>			Our tank ring Lock-it 506011-7 / Basic 516011-7 fits all KTM models with 7 hole mounting.			650769 01 01	Rear rack		650769 01 01	Rear rack	
6507504 00 01	Side carrier		506011-7	Tank ring Lock-it 7-hole		<b>LC 4 640 Adventure (1998-2003)</b>			650769 01 01	Rear rack	
6507504 01 01	Alurack		516011-7	Tank ring Basic 7-hole		650769 00 01	Side carrier	0	650769 01 01	Rear rack	
6617504 01 01	Easyrack		Our tank ring Lock-it 506003-6 / Basic 516003-6 fits all KTM models with 6 hole mounting.			650769 00 01	Side carrier	0	<b>LC 4 Adventure (1998-2003)</b>		
6307504 00 01	C-Bow holder	111	506003-6	Tank ring Lock-it 6-hole		650758 00 01	Side carrier	0	650758 00 01	Side carrier	0
5017504 00 01	Engine guard		516003-6	Tank ring Basic 6-hole		650758 01 01	Rear rack	3:B3	<b>690 SMC R / 690 Enduro R (2019-)</b>		
506011-7	Tank ring Lock-it (-2013)		516003-6	Tank ring Basic 6-hole		42117582 00 91			Side stand enlargement		
506001-6	Tank ring Lock-it (2014-2016)		Our tank ring Lock-it 506016-7 / Basic 516016-7 fits all KTM models with 7 hole mounting.								
516011-7	Tank ring Basic (-2013)		506016-7	Tank ring Lock-it 7-hole							
516001-6	Tank ring Basic (2014-2016)		516016-7	Tank ring Basic 7-hole							

**ATTENTION: You can find the new 2024 models online at [www.hepco-becker.de](http://www.hepco-becker.de)**



Info reference see p. 271

The last digit of the item-no. refers to the colours: 01= black 02= chrome 03= white 04= red 05= anthracite 06= orange 08= yellow 09= silver 10= blue metallic 12= Alu brushed 22= Stainless steel 91= silver/black

Item-no.	Description	Info's
<b>790 Adventure / R (2019-)</b>		
6537581 00 01	Side carrier	
6517581 00 22	Cutout carrier	4:C3,C4
6517581 00 22-00-40	Xplorer Cutout Set	
6517581 00 22-01-40	Xplorer Cutout Set Black	
5017581 00 01	Engine guard	
5017581 00 06	Engine guard	
5017581 00 22	Engine guard	
6557581 01 01	Alurack f. Original rack	
6627581 01 01	Easyrack f. Original rack	
6527581 01 01	Alurack (R Version)	
6617581 01 01	Easyrack (R Version)	
6307581 00 01	C-Bow holder	
42127581 00 01	Handle guard	
8007581 00 01	Rear rack enlargement	
42117581 00 91	Side stand enlargement	
5067581 00 01	Tank ring Lock-it	
5167581 00 01	Tank ring Basic	
7007581 00 01	Headlight grilles	112
42267634 00 01	Additional plate f. original skid plate	
741100 00 01	Tool box	
<b>890 Duke R (2020-)</b>		
6317602 00 01L	C-Bow holder, one-sided left	
6527602 01 01	Alurack	156
6617602 01 01	Easyrack	156
6607602 01 01	Minirack	156
5067602 00 01	Tank ring Lock-it	914
5167602 00 01	Tank ring Basic	714
5017602 00 01	Engine guard incl. Protectionpad	
5017602 00 06	Engine guard incl. Protectionpad	
6707602 00 01	Sportrack	52
42247602 00 91	Heat shield	

Item-no.	Description	Info's
<b>890 Adventure / R / Rally (2021-2022)</b>		
6537617 00 01	Side carrier	
6517617 00 22	Cutout carrier	4:C3,C4
6517617 00 22-00-40	Xplorer Cutout Set	
6517617 00 22-01-40	Xplorer Cutout Set Black	
5017617 00 01	Engine guard	
5017617 00 06	Engine guard	
5017617 00 22	Engine guard	
6557617 01 01	Alurack f. Original rack	
6627617 01 01	Easyrack f. Original rack	
6527617 01 01	Alurack	
6617617 01 01	Easyrack	
6307617 00 01	C-Bow holder	
42127617 00 01	Handle guard	
8007617 00 01	Rear rack enlargement	
42117617 00 91	Side stand enlargement	
5067617 00 01	Tank ring Lock-it	
5167617 00 01	Tank ring Basic	
7007617 00 01	Headlight grilles	112
42267634 00 01	Additional plate f. original skid plate	
741100 00 01	Tool box	

Item-no.	Description	Info's
<b>890 SMT (2023-)</b>		
6537655 00 01	Side carrier	
6517655 00 22-00-40	Xplorer Cutout Set	
6517655 00 22-01-40	Xplorer Cutout Set Black	
6517655 00 22	Cutout carrier	4:C3,C4
6307655 00 01	C-Bow Holder	
5067655 00 01	Tank ring Lock-it	
5167655 00 01	Tank ring Basic	
6527655 01 01	Alurack	
6617655 01 01	Easyrack	
6557655 01 01	Alurack f. original rack	
6627655 01 01	Easyrack f. original rack	
8007655 00 01	Rear rack enlargement	
5017655 00 06	Engine guard	
5017655 00 01	Engine guard	
42127655 00 01	Handle guard	
42117655 00 91	Side stand enlargement	
741100 00 01	Tool Box	

Item-no.	Description	Info's
<b>890 Adventure / R / Rally (2023-)</b>		
6537656 00 01	Side carrier	
6517656 00 22-00-40	Xplorer Cutout Set	
6517656 00 22-01-40	Xplorer Cutout Set Black	
6517656 00 22	Cutout carrier	4:C3,C4
6307656 00 01	C-Bow Holder	
5067656 00 01	Tank ring Lock-it	
5167656 00 01	Tank ring Basic	
6527656 01 01	Alurack	
6617656 01 01	Easyrack	
6557656 01 01	Alurack f. original rack	
6627656 01 01	Easyrack f. original rack	
8007656 00 01	Rear rack enlargement	
5017656 00 01	Engine guard	
5017656 00 06	Engine guard	
42127656 00 01	Handle guard	
7007656 00 01	Headlight grille	112
42267656 00 01	Additional plate for skid plate	
42117656 00 91	Side stand enlargement	
741100 00 01	Tool Box	

**NOTICE Tank rings KTM**

Our tank ring Lock-it 506011-7 / Basic 516011-7 fits all KTM models with 7 hole mounting.

506011-7	Tank ring Lock-it 7-hole
516011-7	Tank ring Basic 7-hole

Our tank ring Lock-it 506003-6 / Basic 516003-6 fits all KTM models with 6 hole mounting.

506003-6	Tank ring Lock-it 6-hole
516003-6	Tank ring Basic 6-hole

Our tank ring Lock-it 506016-7 / Basic 516016-7 fits all KTM models with 7 hole mounting.

506016-7	Tank ring Lock-it 7-hole
516016-7	Tank ring Basic 7-hole

**ATTENTION: You can find the new 2024 models online at [www.hepco-becker.de](http://www.hepco-becker.de)**



Item-no.	Description	Info's	Item-no.	Description	Info's	Item-no.	Description	Info's	Item-no.	Description	Info's
<b>950 LC 8 Adventure / S (2003-2005)</b>			<b>1050 Adventure (2015-2016)</b>			<b>1090 Adventure (2017-)</b>			<b>1090 Adventure R (2017-)</b>		
650785 00 01	Side carrier		6507524 00 01	Side carrier Lock-it asymmetric	0, 108	6507556 00 01	Side carrier Lock-it symmetric		6507563 00 01	Side carrier Lock-it symmetric	
650785 01 01	Rear rack	9	6507519 00 01	Side carrier Lock-it symmetric	107, 108	6567556 00 01	Side carrier Lock-it asymmetric		6567563 00 01	Side carrier Lock-it asymmetric	
502785 00 01	Engine guard		6507519 01 01	Alurack	9	6517556 00 22-00-40	Cutout carrier	4:C3,C4	6517563 00 22	Cutout carrier	4:C3,C4
700785 00 01	Headlight grilles	112	6617519 01 01	Easyrack	9	6517556 00 22-00-40	Xplorer Cutout Set		6517563 00 22-00-40	Xplorer Cutout Set	
<b>990 LC 8 Supermoto (2005)</b>			6517519 00 22-00-40	Xplorer Cutout Set		6517556 00 22-01-40	Xplorer Cutout Set black		6517563 00 22-01-40	Xplorer Cutout Set black	
650708 01 01	Rear rack	9	6517519 00 22-01-40	Xplorer Cutout Set black		6557556 01 01	Alurack f. Original rack		6557563 01 01	Alurack f. Original rack	
<b>990 LC 8 Adventure / S (2006-2013)</b>			5017519 00 01	Engine guard		6627556 01 01	Easyrack f. Original rack		6627563 01 01	Easyrack f. Original rack	
650785 00 01	Side carrier		8107519 00 09	Skid plate		5017556 00 01	Engine guard		8107563 00 12	Skid plate	
650785 01 01	Rear rack	9	8007524 00 01	Rear rack enlargement		8107556 00 12	Skid plate	112	7007563 00 01	Headlight grilles	112
4211785 00 91	Side stand enlargement		7007519 00 01	Headlight grilles	112	7007556 00 01	Headlight grilles	112	8007563 00 01	Rear rack enlargement	
502785 00 01	Engine guard		42117524 00 91	Side stand enlargement		8007556 00 01	Rear rack enlargement		42117563 00 91	Side stand enlargement	
<b>990 Super Duke R (2005-2013)</b>			4207519-01	Handle guard		42117556 00 91	Side stand enlargement		5067563 00 01	Tank ring Lock-it	902
506001-6	Tank ring Lock-it					5067556 00 01	Tank ring Lock-it	902	5167563 00 01	Tank ring Basic	702
516001-6	Tank ring Basic					5167556 00 01	Tank ring Basic	702	42127563 00 01	Handle guard	
<b>990 Supermoto R (2011)</b>						42127556 00 01	Handle guard		5027563 00 06	Tank guard	94
650763 01 01	Alurack	9							640100 00 01	Crash bar bag set V1	
661763 01 01	Easyrack	9									
630763 00 01	C-Bow holder										

## NOTICE Tank rings KTM

Our tank ring Lock-it 506011-7/ Basic 516011-7 fits all KTM models with 7 hole mounting.

506011-7 Tank ring Lock-it 7-hole

516011-7 Tank ring Basic 7-hole

Our tank ring Lock-it 506003-6 / Basic 516003-6 fits all KTM models with 6 hole mounting.

506003-6 Tank ring Lock-it 6-hole

516003-6 Tank ring Basic 6-hole

Our tank ring Lock-it 506016-7 / Basic 516016-7 fits all KTM models with 7 hole mounting.

506016-7 Tank ring Lock-it 7-hole

516016-7 Tank ring Basic 7-hole



**ATTENTION: You can find the new 2024 models online at [www.hepco-becker.de](http://www.hepco-becker.de)**



Info reference see p. 271

The last digit of the item-no. refers to the colours: 01= black 02= chrome 03= white 04= red 05= anthracite 06= orange 08= yellow 09= silver 10= blue metallic 12= Alu brushed 22= Stainless steel 91= silver/black

Item-no.	Description	Info's
<b>1190 Adventure (2013-2016)</b>		
6507524 00 01	Side carrier Lock-it asymmetric	0, 108
6507519 00 01	Side carrier Lock-it symmetric	107, 108
6517519 00 22	Cutout carrier	4:C3,C4
6517519 00 22-00-40	Xplorer Cutout Set	
6517519 00 22-01-40	Xplorer Cutout Set black	
6507519 01 01	Alurack	9
6617519 01 01	Easyrack	9
5017519 00 01	Engine guard	
8107519 00 09	Skid plate	
8007519 00 01	Rear rack enlargement	
7007519 00 01	Headlight grilles	112
5067519 00 01	Tank ring Lock-it	902
5167519 00 01	Tank ring Basic	702
42117519 00 91	Side stand enlargement (2013)	
42117524 00 91	Side stand enlargement (2014-)	
4207519-01	Handle guard	

Item-no.	Description	Info's
<b>1190 Adventure R (2013-)</b>		
6507524 00 01	Side carrier Lock-it asymmetric	0, 108
6507519 00 01	Side carrier Lock-it symmetric	107, 108
6517519 00 22	Cutout carrier	4:C3,C4
6517519 00 22-00-40	Xplorer Cutout Set	
6517519 00 22-01-40	Xplorer Cutout Set black	
6507519 01 01	Alurack	9
6617519 01 01	Easyrack	9
5027524 00 06	Tank guard	94
640100 00 01	Crash bar bag set V1	
8107524 00 09	Skid plate	
8007519 00 01	Rear rack enlargement	
7007519 00 01	Headlight grilles	112
4207519-01	Handle guard	
5067524 00 01	Tank ring Lock-it	902
5167524 00 01	Tank ring Basic	702
42117519 00 91	Side stand enlargement (2013)	
42117524 00 91	Side stand enlargement (2014-)	

Item-no.	Description	Info's
<b>1190 RC8 (2008-2015)</b>		
670707 00 01	Sportrack	52
<b>1290 Super Duke / R (2014-2019)</b>		
630712 00 01	C-Bow holder	89,123
670712 00 01	Sportrack (-2016)	52
6707564 00 01	Sportrack	52
506712 00 01	Tank ring Lock-it	902
516712 00 01	Tank ring Basic	702

Item-no.	Description	Info's
<b>1290 Super Duke R / Evo (2020-)</b>		
6307603 00 01	C-Bow holder	111
6707603 00 01	Sportrack	52
5067603 00 01	Tank ring Lock-it	902
5167603 00 01	Tank ring Basic	702
5017603 00 06	Engine guard incl. Protectionpad	
<b>1290 Super Adventure (2015-2020)</b>		
6507533 00 01	Side carrier Lock-it symmetric	107, 108
6507524 00 01	Side carrier Lock-it asymmetric	0, 108
6517533 00 22	Cutout carrier	4:C3,C4
6517533 00 22-00-40	Xplorer Cutout Set	
6517533 00 22-01-40	Xplorer Cutout Set black	
6507533 01 01	Alurack	
6617533 01 01	Easyrack	
5017533 00 01	Engine guard	
8107533 00 09	Skid plate	
8007533 00 01	Rear rack enlargement	
7007533 00 01	Headlight grilles	112,230
4207533-01	Handle guard	
5067533 00 01	Tank ring Lock-it	902
5167533 00 01	Tank ring Basic	702
42117533 00 91	Side stand enlargement	

Item-no.	Description	Info's
<b>1290 Super Adventure S / R (2021-)</b>		
6537627 00 01	Side carrier asymmetric	0,2- C1,C2, B1,B2, A1, A2
6557627 01 01	Alurack	
6627627 01 01	Easyrack	
5067627 00 01	Tank ring Lock-it	
5167627 00 01	Tank ring Basic	
8007627 00 01	Rear rack enlargement	
42127627 00 01	Handle guard	
7007627 00 01	Headlight grilles	112
42117627 00 91	Side stand enlargement	
<b>1290 Super Duke GT (2016-)</b>		
6527541 01 01	Alurack	
6617541 01 01	Easyrack	
6607541 01 01	Minirack	
6307541 00 01	C-Bow holder	
6707541 00 01	Sportrack	52
5067541 00 01	Tank ring Lock-it	902
5167541 00 01	Tank ring Basic	702

### NOTICE Tank rings KTM

Our tank ring Lock-it 506011-7 / Basic 516011-7 fits all KTM models with 7 hole mounting.

506011-7 Tank ring Lock-it 7-hole

516011-7 Tank ring Basic 7-hole

Our tank ring Lock-it 506003-6 / Basic 516003-6 fits all KTM models with 6 hole mounting.

506003-6 Tank ring Lock-it 6-hole

516003-6 Tank ring Basic 6-hole

Our tank ring Lock-it 506016-7 / Basic 516016-7 fits all KTM models with 7 hole mounting.

506016-7 Tank ring Lock-it 7-hole

516016-7 Tank ring Basic 7-hole

**ATTENTION: You can find the new 2024 models online at [www.hepco-becker.de](http://www.hepco-becker.de)**





Item-no.	Description	Info's
<b>V 35 I / II (1977-1986)</b>		
650507 00 02	Complete carrier	
<b>V 35 III (1987)</b>		
650514 00 02	Complete carrier	
<b>V 35 Imola (1979-1984)</b>		
650501 00 02	Complete carrier	
<b>V 50 / V 50 II / III (1977-1986)</b>		
650500 00 02	Complete carrier	
<b>V 50 C (1982-1987)</b>		
650508 00 02	Complete carrier	
<b>V 50 III (1987)</b>		
650514 00 02	Complete carrier	
<b>V 50 Monza (1979-1984)</b>		
650501 00 02	Complete carrier	
<b>V 65</b>		
650509 00 02	Complete carrier	
<b>V 65 C (1982-1987)</b>		
650508 00 02	Complete carrier	
<b>V 65 Florida (1992-)</b>		
650520 00 02	Side carrier	
650520 01 02	Rear rack	
<b>V 65 GT (1987)</b>		
650514 00 02	Complete carrier	

## NOTICE Tank rings MOTO GUZZI

Our tank ring Lock-it 506001-6 / Basic 516001-6 fits all MOTO GUZZI models with 6 hole mounting.

506001-6 Tank ring Lock-it 6-hole

516001-6 Tank ring Basic 6-hole

Our tank ring Lock-it 506012-5 / Basic 516012-5 fits all MOTO GUZZI models with 5 hole mounting.

506012-5 Tank ring Lock-it 5-hole

516012-5 Tank ring Basic 5-hole

Our Tank ring Lock-it 506014-5 / Basic 516014-5 is for MOTO GUZZI V7 models with plastic tank only.

506014-5 Tank ring Lock-it 5-hole plastic tank

516014-5 Tank ring Basic 5-hole plastic tank

Item-no.	Description	Info's
<b>V 65 Lario (1984-1987)</b>		
650511 00 01	Complete carrier	
650511 01 01	Rear rack	22
<b>V 65 NTX (1987)</b>		
650515 00 01	Side carrier	0
<b>V 65 TT (1985)</b>		
650513 00 01	Side carrier	0
<b>Breva V 750 ie (2003-)</b>		
650532 00 01	Side carrier	
650532 01 01	Rear rack	
630532 00 01	C-Bow holder	
501505 00 01	Engine guard	
501505 00 02	Engine guard	
505532 00 01	Center stand	8
506505 00 01	Tank ring Lock-it (2005-)	900
516505 00 01	Tank ring Basic (2005-)	700
<b>Nevada 750 (1992-2002)</b>		
650522 00 02	Side carrier	48
650522 01 02	Rear rack	48
<b>Nevada 750 Club (1998-2001)</b>		
650522 00 02	Side carrier	48
650522 01 02	Rear rack	48
<b>Nevada 750 Anniversario (2010-2011)</b>		
650543 00 02	Side carrier	
650543 01 02	Rear rack	
630543 00 02	C-Bow leather bag holder	
501543 00 02	Engine guard	
505543 00 01	Center stand	
611543 00 02	Sissybar with rack	59
600543 00 02	Sissybar without rack	59
400543 00 02	Twinlight Set	

Item-no.	Description	Info's
<b>Nevada Aquila Nera (2010-2011)</b>		
650534 00 02	Side carrier	
650534 01 02	Rear rack	
625534 00 02	Leather bag holder tube type	
501506 00 02	Engine guard	8
505532 00 01	Center stand	8
611534 00 02	Sissybar with rack	59
600534 00 02	Sissybar without rack	59
400534 00 02	Twinlight Set	
<b>Nevada Classic V 750 (2004-)</b>		
650534 00 02	Side carrier (-2009)	
650534 01 02	Rear rack	
625534 00 02	Leather bag holder tube type	
611534 00 02	Sissybar with rack	59
505532 00 01	Center stand (-2009)	
505543 00 01	Center stand (2010-)	
501506 00 02	Engine guard	8
600534 00 02	Sissybar without rack	59
400534 00 02	Twinlight Set	
<b>V 75 (1986)</b>		
650514 00 02	Complete carrier	
<b>V7 Cafe classic (2009-2011)</b>		
650540 01 01	Rear rack	3: B3
650540 01 02	Rear rack	3: B3
630540 00 01	C-Bow holder	
630540 00 02	C-Bow holder	
501540 00 01	Engine guard	
501540 00 02	Engine guard	
506540 00 01	Tank ring Lock-it	128, 910
506541 00 01	Tank ring Lock-it	127, 912
516540 00 01	Tank ring Basic	128, 710
516541 00 01	Tank ring Basic	127, 712

Item-no.	Description	Info's
<b>V7 Classic (2008-2011)</b>		
650540 00 01	Side carrier	
650540 00 02	Side carrier	
650540 01 01	Rear rack	
650540 01 02	Rear rack	
630541 00 01	C-Bow holder	
630541 00 02	C-Bow holder	
501540 00 01	Engine guard	
501540 00 02	Engine guard	
506540 00 01	Tank ring Lock-it	128, 910
506541 00 01	Tank ring Lock-it	127, 912
516540 00 01	Tank ring Basic	128, 710
516541 00 01	Tank ring Basic	127, 712
<b>V7 Special (2012-2014)</b>		
650540 00 01	Side carrier	
650540 00 02	Side carrier	
650540 01 01	Rear rack	
650540 01 02	Rear rack	
630541 00 01	C-Bow holder	
630541 00 02	C-Bow holder	
501540 00 01	Engine guard	
501540 00 02	Engine guard	
506540 00 01	Tank ring Lock-it	128, 910
506541 00 01	Tank ring Lock-it	127, 912
516540 00 01	Tank ring Basic	128, 710
516541 00 01	Tank ring Basic	127, 712

➔➔➔ **ATTENTION: You can find the new 2024 models online at [www.hepco-becker.de](http://www.hepco-becker.de)**



Info reference see p. 271

The last digit of the item-no. refers to the colours: 01= black 02= chrome 03= white 04= red 05= anthracite 06= orange 08= yellow 09= silver 10= blue metallic 12= Alu brushed 22= Stainless steel 91= silver/black

Item-no.	Description	Info's	Item-no.	Description	Info's	Item-no.	Description	Info's	Item-no.	Description	Info's
<b>V7 II (2015-2016)</b>			<b>V7 III / Stone / Special / Anniversario / Racer (2017-2020)</b>			<b>V7 Special/ Stone/ Stone Centenario (850 CCM) (2021-)</b>			<b>Breva V 850 (2006-2009)</b>		
650545 00 01	Side carrier		653550 00 01	Side carrier	75,3:E	653556 00 01	Side carrier	91	650535 00 01	Side carrier	
650545 00 02	Side carrier		653550 00 02	Side carrier	75,3:E 243	653556 00 02	Side carrier	91	650535 01 01	Rear rack	
650545 01 01	Rear rack	3: B3	654550 01 01	Rear rack	75,3:B3 243	630556 00 01	C-Bow holder		630535 00 01	C-Bow holder	
650545 01 02	Rear rack	3: B3	654550 01 02	Rear rack	75,3:B3 243	630556 00 02	C-Bow holder		501507 00 01	Engine guard	
630545 00 01	C-Bow holder		630550 00 01	C-Bow holder	3:H,K2 243	654556 01 01	Rear rack		<b>850 Le Mans II (1978-1982)</b>		
630545 00 02	C-Bow holder		630550 00 02	C-Bow holder	3:H,K2 243	654556 01 02	Rear rack		650504 00 02	Complete carrier	
501545 00 01	Engine guard		501550 00 01	Engine guard		658556 01 01	Rear rack	141	<b>850 Le Mans III (1982-1985)</b>		
501545 00 02	Engine guard		501550 00 02	Engine guard		600556 00 01	Sissybar without rack		650505 00 02	Complete carrier	
505545 00 01	Center stand		505550 00 01	Center stand		611556 00 01	Sissybar with rack		<b>850 T 5 (1985-1987)</b>		
4221545 00 01	Jacking lever f. Center stand		400550 00 01	Twinlight Set		600556 01 01	Sissybar without rack	188	650510 00 02	Complete carrier	
506545 00 01	Tank ring Lock-it	910	<b>V7 III Carbon/ Milano/ Rough (2018-2020)</b>			611556 01 01	Sissybar with rack	188	<b>850 T/T 2/T 3/T 4 California (1973-1983)</b>		
516545 00 01	Tank ring Basic	710	653553 00 01	Side carrier	75,3:E	501556 00 01	Engine guard		650502 00 02	Complete carrier	
<b>V7 II Stornello / Scrambler (2016-)</b>			653553 00 02	Side carrier	75,3:E	501556 00 02	Engine guard		<b>V85 TT (2019-) / Travel (2020-)</b>		
653548 00 01	Side carrier	36	654553 01 01	Rear rack	75,3:B3	505556 00 01	Center stand		653554 00 01	Side carrier	0
653548 00 02	Side carrier	36	654553 01 02	Rear rack	75,3:B3	400556 00 01	Twinlight Set		655554 01 01	Alurack f. Original rack	
654548 01 01	Rear rack	3: B3	630553 00 01	C-Bow holder	3:H,K2	700558 00 01	Headlight grille	112	662554 01 01	Easyrack f. Original rack	
654548 01 02	Rear rack	3: B3	630553 00 02	C-Bow holder	3:H,K2	<b>V7 Stone Special Edition (850 ccm) (2022-)</b>			630554 00 01	C-Bow holder	
630548 00 01	C-Bow holder	36	501553 00 01	Engine guard		653558 00 01	Side carrier	4:A,F	501554 00 01	Engine guard	
505548 00 01	Center stand		501553 00 02	Engine guard		630558 00 01	C-Bow holder	3:K2	4212554 00 01	Handle guard	
4221548 00 01	Jacking lever f. Center stand		505553 00 01	Center stand		630558 00 02	C-Bow holder	3:K2	700554 00 01	Headlight grilles	112
506548 00 01	Tank ring Lock-it	910	4221553 00 01	Jacking lever f. Center stand		654558 01 01	Rear rack		4211554 00 91	Side stand enlargement (2019)	
516548 00 01	Tank ring Basic	710	400553 00 01	Twinlight Set		654558 01 02	Rear rack		4211555 00 91	Side stand enlargement (2020-)	
501548 00 01	Engine guard					658558 01 01	Rear rack	189	506554 00 01	Tank ring Lock-it	3:L5
						600558 00 01	Sissybar without rack	203	516554 00 01	Tank ring Basic	3:L5
						611558 00 01	Sissybar with rack	203	731107	Nova LED auxiliary headlights	
						600558 01 01	Sissybar without rack	203,188			
						611558 01 01	Sissybar with rack	203,188			
						501558 00 01	Engine guard				
						501558 00 02	Engine guard				
						505558 00 01	Center stand				
						400558 00 01	Twinlight Set				
						700558 00 01	Headlight grille	112			

### NOTICE Tank rings MOTO GUZZI

Our tank ring Lock-it 506001-6 / Basic 516001-6 fits all MOTO GUZZI models with 6 hole mounting.

506001-6	Tank ring Lock-it 6-hole
516001-6	Tank ring Basic 6-hole

Our tank ring Lock-it 506012-5 / Basic 516012-5 fits all MOTO GUZZI models with 5 hole mounting.

506012-5	Tank ring Lock-it 5-hole
516012-5	Tank ring Basic 5-hole

Our Tank ring Lock-it 506014-5 / Basic 516014-5 is for MOTO GUZZI V7 models with plastic tank only.

506014-5	Tank ring Lock-it 5-hole plastic tank
516014-5	Tank ring Basic 5-hole plastic tank

**ATTENTION: You can find the new 2024 models online at [www.hepco-becker.de](http://www.hepco-becker.de)**



Item-no.	Description	Info's	Item-no.	Description	Info's	Item-no.	Description	Info's	Item-no.	Description	Info's
<b>V9 Roamer (2016-)</b>			<b>V9 Bobber / Special Edition (2021-)</b>			<b>V10 Centauro GT (1997-2000)</b>			<b>V100 Mandello (2022-)</b>		
626546 00 01	Rugged Cutout	4:R2	626559 00 01	Rugged Cutout	4:R2	650523 00 01	Side carrier		653557 00 01	Side carrier	207
630546 00 01	C-Bow holder	146	630559 00 01	C-Bow holder	146, 3:P, S	650523 01 01	Rear rack		630557 00 01	C-Bow holder	207
654546 01 01	Rear rack	80	654559 01 01	Rear rack tube type	81	<b>V10 Centauro Sport (1997-2000)</b>			506557 00 01	Tank ring Lock-it	900, 3: L5, L6
654551 01 01	Rear rack	81	654559 01 02	Rear rack tube type	81	650523 00 01	Side carrier		516557 00 01	Tank ring Basic	700, 3: L5, L6
654551 01 02	Rear rack	81	611559 00 01	Sissybar with rear rack	81	650523 01 01	Rear rack		4219557 00 01	Pillion handle	23,208
501546 00 01	Engine guard		600559 00 01	Sissybar without rear rack	81	<b>Quota 1000 (1992-1998)</b>			652557 01 01	Alurack	56
501546 00 02	Engine guard		613559 00 01	Solorack	52	650519 00 01	Side carrier	0	661557 01 01	Easyrack	56
4220546 00 01	Canister Cutout set		4216559 00 01	Driver's back rest	148	650519 01 01	Rear rack		660557 01 01	Minirack	56
505546 00 01	Center stand		501559 00 01	Engine guard		501503 00 01	Engine guard		800557 00 01	Rear rack enlargement	56
4221546 00 01	Jacking lever f. Center stand		501559 00 02	Engine guard		<b>1000 SP (1980)</b>			658557 01 01	Rear rack tube type	189
611551 00 01	Sissybar with rack	81	700559 00 01	Headlight grille		650503 00 02	Complete carrier	19	501557 00 01	Engine guard	
600551 00 01	Sissybar without rack	81	4220559 00 01	Canister Cutout		<b>1000 SP II Mille GT (1985-1987)</b>			810557 00 01	Belly pan	
<b>V9 Bobber (2016-2020)/ Sport</b>			505559 00 01	Center stand		650510 00 02	Compleat carrier		810557 00 00	Belly pan Titan	
626547 00 01	Rugged Cutout	4:R2	4221559 00 01	Jacking lever f. Center stand		<b>California 1000 II (-1985)</b>			810557 00 00	Center stand	
630547 00 01	C-Bow holder	146, 3:P, S, 244	<b>Griso 850 (2006-)</b>			650530 00 02	Side carrier		4211557 00 91	Side stand enlargement	
654547 01 01	Rear rack	80,244	650537 00 01	Side carrier	30,190	650530 01 02	Rear rack		<b>California Aquila Nera (2011-)</b>		
654552 01 01	Rear rack	81,244	650537 01 01	Rear rack	30,190	<b>California 1000 II (1985-)</b>			650542 00 02	Side carrier	
654552 01 02	Rear rack	80,244	630537 00 01	C-Bow holder		650506 00 02	Side carrier		650542 01 02	Rear rack	
501547 00 01	Engine guard		501508 00 01	Engine guard		<b>California III (1988-)</b>			501542 00 02	Engine guard	
501547 00 02	Engine guard		<b>C 940 Bellagio/Bellagio Aquila Nera (2007-)</b>			650517 00 02	Side carrier		410542 00 02	Fender Guard	
4220547 00 01	Canister Cutout set		650539 01 01	Rear rack		650517 01 02	Rear rack		400542 00 02	Twinlight Set	67
505547 00 01	Center stand		625539 00 01	Leather bag holder tube type		<b>Le Mans IV / V (1985-1994)</b>					
4221547 00 01	Jacking lever f. Center stand		630539 00 01	C-Bow holder	149	650512 00 01	Complete carrier				
611552 00 01	Sissybar with rack	81	630539 00 02	C-Bow holder	149	650512 01 01	Rear rack				
600552 00 01	Sissybar without rack	81	501510 00 01	Engine guard							
			501510 00 02	Engine guard							
			400539 00 01	Twinlight Set							
			400539 00 02	Twinlight Set							
			<b>Le Mans 1000 S</b>								
			650518 00 02	Complete carrier	22						
			650518 01 02	Rear rack							
			<b>V10 Centauro (1996-2001)</b>								
			650523 00 01	Side carrier							
			650523 01 01	Rear rack							

### NOTICE Tank rings MOTO GUZZI

Our tank ring Lock-it 506001-6 / Basic 516001-6 fits all MOTO GUZZI models with 6 hole mounting.

506001-6 Tank ring Lock-it 6-hole

516001-6 Tank ring Basic 6-hole

Our tank ring Lock-it 506012-5 / Basic 516012-5 fits all MOTO GUZZI models with 5 hole mounting.

506012-5 Tank ring Lock-it 5-hole

516012-5 Tank ring Basic 5-hole

Our Tank ring Lock-it 506014-5 / Basic 516014-5 is for MOTO GUZZI V7 models with plastic tank only.

506014-5 Tank ring Lock-it 5-hole plastic tank

516014-5 Tank ring Basic 5-hole plastic tank



**ATTENTION: You can find the new 2024 models online at [www.hepco-becker.de](http://www.hepco-becker.de)**



Item-no.	Description	Info's	Item-no.	Description	Info's	Item-no.	Description	Info's	Item-no.	Description	Info's
<b>California Jackal (1999)</b>			<b>California Evolution (-2001)</b>			<b>California Stone Touring (2004-)</b>			<b>V 11 Coppa Italia (1999-)</b>		
650525 00 02	Side carrier	60	650521 00 02	Side carrier		650536 01 01	Rear rack		650529 00 01	Complete carrier	2:A1,B1, C1
650525 01 02	Rear rack		650521 01 02	Rear rack		611536 00 01	Sissybar with rack	59	650529 01 01	Rear rack	
501504 00 02	Engine guard		501502 00 02	Rear case guard		410521 00 02	Fender Guard		506529 00 01	Tank ring Lock-it	3:L5,L6
611525 00 02	Sissybar with rack	60	<b>California Evolution / Classic (2001-)</b>			400522 00 02	Twinlight Set	67	516529 00 01	Tank ring Basic	3:L5,L6
600525 00 02	Sissybar without rack	60	650528 00 02	Side carrier		<b>California Titanium (2004)</b>			<b>V 11 Scura (1999-)</b>		
410521 00 02	Fender Guard		650528 01 02	Rear rack		650524 00 02	Side carrier	60	650529 00 01	Complete carrier	2:A1,B1, C1
400521 00 02	Twinlight Set		410521 00 02	Fender Guard		650524 01 02	Rear rack		650529 01 01	Rear rack	
400522 00 02	Twinlight Set	67	400521 00 02	Twinlight Set		<b>Griso 1100 (2005-2008)</b>			506529 00 01	Tank ring Lock-it	3:L5,L6
<b>Breva V 1100 (2004-2007)</b>			400522 00 02	Twinlight Set	67	650537 00 01	Side carrier	30,190	516529 00 01	Tank ring Basic	3:L5,L6
650535 00 01	Side carrier		<b>California Metal (2001)</b>			650537 01 01	Rear rack	30,190	<b>V 11 Sport (2001-)</b>		
650535 01 01	Rear rack		650531 00 02	Side carrier	33	630537 00 01	C-Bow holder		650526 00 01	Complete carrier	2:A1,B1, C1
630535 00 01	C-Bow holder		650531 01 02	Rear rack	33	501508 00 01	Engine guard		650526 01 01	Rear rack	
501507 00 01	Engine guard		501504 00 02	Engine guard		501502 00 02	Rear case guard		506529 00 01	Tank ring Lock-it	3:L5,L6
<b>California 1100 (1993-1995)</b>			611531 00 02	Sissybar with rack	59	400521 00 02	Twinlight Set		516529 00 01	Tank ring Basic	3:L5,L6
650521 00 02	Side carrier		600531 00 02	Sissybar without rack	59	400522 00 02	Twinlight Set	67	<b>V 11 Sport Naked (2001-)</b>		
650521 01 02	Rear rack		410521 00 02	Fender Guard		<b>Quota 1100 ES (1998-2001)</b>			650529 00 01	Complete carrier	2:A1,B1, C1
<b>California 1100i (1994-1998)</b>			<b>California Special / Sport (2001-2002)</b>			650519 00 01	Side carrier	0	650529 01 01	Rear rack	
650521 00 02	Side carrier		650524 00 02	Side carrier	60	650519 01 01	Rear rack		506529 00 01	Tank ring Lock-it	3:L5,L6
650521 01 02	Rear rack		650524 01 02	Rear rack		501503 00 01	Engine guard		516529 00 01	Tank ring Basic	3:L5,L6
410521 00 02	Fender Guard		611524 00 02	Sissybar with rack	60	506519 00 01	Tank ring Lock-it	900	<b>NOTICE Tank rings MOTO GUZZI</b>		
400521 00 02	Twinlight Set		600524 00 02	Sissybar without rack	60	516519 00 01	Tank ring Basic	700	Our tank ring Lock-it 506001-6 / Basic 516001-6 fits all MOTO GUZZI models with 6 hole mounting.		
400522 00 02	Twinlight Set	67	410521 00 02	Fender Guard		<b>V 11 Ballabio (1999-)</b>			506001-6	Tank ring Lock-it 6-hole	
501502 00 02	Rear case guard		400521 00 02	Twinlight Set		650529 00 01	Complete carrier	2:A1,B1, C1	516001-6	Tank ring Basic 6-hole	
<b>California Aluminium (2003)</b>			400522 00 02	Twinlight Set	67	650529 01 01	Rear rack		Our tank ring Lock-it 506012-5 / Basic 516012-5 fits all MOTO GUZZI models with 5 hole mounting.		
650524 00 02	Side carrier	60	<b>California Stone (2001)</b>			506529 00 01	Tank ring Lock-it	3:L5,L6	506012-5	Tank ring Lock-it 5-hole	
650524 01 02	Rear rack		650527 00 02	Side carrier	60	516529 00 01	Tank ring Basic	3:L5,L6	516012-5	Tank ring Basic 5-hole	
<b>California 1100i-75</b>			650527 01 02	Rear rack		<b>V 11 Cafe Sport (1999-)</b>			Our Tank ring Lock-it 506014-5 / Basic 516014-5 is for MOTO GUZZI V7 models with plastic tank only.		
650521 00 02	Side carrier		501504 00 02	Engine guard		650529 00 01	Complete carrier	2:A1,B1, C1	506014-5	Tank ring Lock-it 5-hole plastic tank	
650521 01 02	Rear rack		611527 00 02	Sissybar with rack	60	650529 01 01	Rear rack		516014-5	Tank ring Basic 5-hole plastic tank	
410521 00 02	Fender Guard		600527 00 02	Sissybar without rack	60	506529 00 01	Tank ring Lock-it	3:L5,L6			
400521 00 02	Twinlight Set		410521 00 02	Fender Guard		516529 00 01	Tank ring Basic	3:L5,L6			
400522 00 02	Twinlight Set	67	400521 00 02	Twinlight Set							
501502 00 02	Rear case guard		400522 00 02	Twinlight Set	67						



**ATTENTION: You can find the new 2024 models online at [www.hepco-becker.de](http://www.hepco-becker.de)**



Item-no.	Description	Info's
<b>V11 Le Mans (2001-)</b>		
650529 00 01	Complete carrier	2:A1,B1, C1
650529 01 01	Rear rack	
506529 00 01	Tank ring Lock-it	3:L5,L6
516529 00 01	Tank ring Basic	3:L5,L6
<b>1200 Sport (2007-)</b>		
650538 00 01	Side carrier	
650538 01 01	Rear rack	
630535 00 01	C-Bow holder	
501509 00 01	Engine guard	
<b>Breva V 1200 (2008-2011)</b>		
650535 00 01	Side carrier	
650535 01 01	Rear rack	
630535 00 01	C-Bow holder	
501507 00 01	Engine guard	
<b>Griso 1200 (2007-)</b>		
650537 00 01	Side carrier	30,190
650537 01 01	Rear rack	30,190
630537 00 01	C-Bow holder	
501508 00 01	Engine guard	
<b>Norge 1200 (2006-2011) / Norge GT 8V (2011-)</b>		
650535 00 01	Side carrier	
650535 01 01	Rear rack	
630535 00 01	C-Bow holder	
<b>Stelvio / NTX 1200 (2008-)</b>		
650541 00 01	Side carrier Lock-it	0
650541 01 01	Alurack	9
661541 01 01	Easyrack	9
501541 00 01	Engine guard	
<b>California 1400 Custom / Touring (2013-)</b>		
650544 01 02	Rear rack	28, 34,141
630544 00 02	C-Bow leather bag holder	
501544 00 02	Engine guard	
611544 00 02	Sissybar with rack	28, 34,59
600544 00 02	Sissybar without rack	28, 34,59

Item-no.	Description	Info's
<b>California 1400 Eldorado (2015-)</b>		
630549 00 02	C-Bow holder	87
501549 00 02	Engine guard	
650544 01 02	Rear rack	28,141
611544 00 02	Sissybar with rack	28,59
600544 00 02	Sissybar without rack	28,59
<b>California 1400 Audace (2015-)</b>		
650544 01 02	Rear rack	28,141
611544 00 02	Sissybar with rack	28,59
600544 00 02	Sissybar without rack	28,59

Item-no.	Description	Info's	Item-no.	Description	Info's
<b>NOTICE Tank rings MOTO GUZZI</b>					
Our tank ring Lock-it 506001-6 / Basic 516001-6 fits all MOTO GUZZI models with 6 hole mounting.					
506001-6	Tank ring Lock-it 6-hole		516001-6	Tank ring Basic 6-hole	
Our tank ring Lock-it 506012-5 / Basic 516012-5 fits all MOTO GUZZI models with 5 hole mounting.					
506012-5	Tank ring Lock-it 5-hole		516012-5	Tank ring Basic 5-hole	
Our Tank ring Lock-it 506014-5 / Basic 516014-5 is for MOTO GUZZI V7 models with plastic tank only.					
506014-5	Tank ring Lock-it 5-hole plastic tank		516014-5	Tank ring Basic 5-hole plastic tank	



**ATTENTION: You can find the new 2024 models online at [www.hepco-becker.de](http://www.hepco-becker.de)**



Info reference see p. 271

The last digit of the item-no. refers to the colours: 01= black 02= chrome 03= white 04= red 05= anthracite 06= orange 08= yellow 09= silver 10= blue metallic 12= Alu brushed 22= Stainless steel 91= silver/black

Item-no.	Description	Infos	Item-no.	Description	Infos	Item-no.	Description	Infos	Item-no.	Description	Infos
<b>DR 125 SE (1995-1998)</b>			<b>GN (X) 250 E (1984-1999)</b>			<b>DR-Z 400 / S (2000-2005)</b>			<b>GS 550 Katana (1980-1983)</b>		
650388 01 01	Rear rack		650326 00 02	Complete carrier	5: A,B,C,D,E,F	650317 00 01	Side carrier	0	650307 00 01	Complete carrier	
<b>GN 125 (1991-1996)</b>			650326 01 02	Rear rack	22	650317 01 01	Rear rack		650307 01 01	Rear rack	22
650375 00 02	Complete carrier	5: A,B,C,D,E,F	<b>GSX 250 E (1982-1983)</b>			<b>GN 400 TD (1980-1983)</b>			<b>GS 550 T (1980-1984)</b>		
650375 01 02	Rear rack	22	650303 00 01	Complete carrier		650327 00 02	Complete carrier		650328 00 02	Complete carrier	15
501311 00 02	Engine guard		650303 01 01	Rear rack		<b>GSF 400 Bandit (1991-1995)</b>			<b>GSX 550 ES (1982-1988)</b>		
<b>GSX-R 125 (2017-)</b>			<b>GZ 250 Marauder (1999-2001)</b>			650358 00 01	Complete carrier	5: A,B,C,D,E,F	650318 00 01	Complete carrier	17
6703535 00 01	Sportrack	52	650300 01 02	Rear rack		506358 00 01	Tank ring Lock-it	907	<b>GSX 550 EF/EU (1982-1988)</b>		
5063535 00 01	Tank ring Lock-it	908	625300 00 02	Leather bag holder tube type		516358 00 01	Tank ring Basic	707	650318 00 01	Complete carrier	17
5163535 00 01	Tank ring Basic	708	501317 00 02	Engine guard		650358 01 01	Rear rack	22	<b>VS 600 GLP Intruder (1995-1997)</b>		
<b>GSX-S 125 (2017-)</b>			611314 00 02	Sissybar with Rack	59	<b>GSX 400 E (1982-1987)</b>			650367 00 02	Complete carrier	48
6703536 00 01	Sportrack	52	600314 00 02	Sissybar without Rack	59	650303 00 01	Complete carrier		650367 01 02	Rear rack	
5063536 00 01	Tank ring Lock-it	908	611315 00 02	Solorack with Pad	59	650303 01 01	Rear rack		625367 00 02	Leather bag holder tube type	
5163536 00 01	Tank ring Basic	708	600315 00 02	Solorack without Pad	59	<b>GS 450 S (1988-1989)</b>			501307 00 02	Engine guard	
5013536 00 01	Engine guard		<b>VL 250 LC Intruder (2000-2001)</b>			650303 00 01	Complete carrier		611309 00 02	Sissybar with Rack	59
5033536 00 01	Front guard		650330 01 02	Rear rack		650303 01 01	Rear rack		600309 00 02	Sissybar without Rack	59
5043536 00 01	Rear guard		625330 00 02	Leather bag holder tube type		<b>DR 500 (1981-1984)</b>			400367 00 02	Twinlight Set	
<b>GZ 125 Marauder (1998-2001)</b>			501330 00 02	Engine guard		650324 00 01	Complete carrier	0	<b>DR 600 Dakar (1986-1989)</b>		
650300 01 02	Rear rack		611330 00 02	Sissybar with Rack	59	<b>GS 500 E (1989-2000)</b>			650346 00 01	Side carrier	0
625300 00 02	Leather bag holder tube type		600330 00 02	Sissybar without Rack	59	650348 00 01	Complete carrier	5: A,B,C,D,E,F	<b>DR 600 Dakar (1989-1990)</b>		
501314 00 02	Engine guard		611316 00 02	Solorack with Pad	59	650348 01 01	Rear rack	22	650351 00 01	Side carrier	0
611314 00 02	Sissybar with Rack	59	600316 00 02	Solorack without Pad	59	501301 00 01	Engine guard	228	650351 01 01	Rear rack	9
600314 00 02	Sissybar without Rack	59	400330 00 02	Twinlight Set		506348 00 01	Tank ring Lock-it	907	<b>DR 600 R (1986-1989)</b>		
611315 00 02	Solorack with Pad	59	<b>DR 350 S/SH (1990-)</b>			516348 00 01	Tank ring Basic	707	650346 00 01	Side carrier	0
600315 00 02	Solorack without Pad	59	650355 00 01	Complete carrier	0,8	<b>GS 500 E / F (2001-2008)</b>			<b>DR 600 S (1986-1989)</b>		
<b>UH 125 Burgman (2002-2006)</b>			650355 01 01	Rear rack	8	650334 00 01	Side carrier		650346 00 01	Side carrier	0
650378 01 01	Rear rack		<b>AN 400 Burgman (2003-2005)</b>			650334 01 01	Rear rack		<b>NOTICE Tank rings SUZUKI</b>		
<b>VL 125 Intruder (1999-2007)</b>			650397 01 01	Rear rack		501301 00 01	Engine guard	228	Our tank ring Lock-it 506010-5 / Basic 516010-5 fits all SUZUKI models with 5 hole mounting.		
650330 01 02	Rear rack		<b>AN 400 Burgman (2007-2009)</b>			503334 00 01	Front guard		506010-5	Tank ring Lock-it 5 hole	
625330 00 02	Leather bag holder tube type		6503514 01 01	Rear rack		504334 00 01	Rear guard		516010-5	Tank ring Basic 5 hole	
501330 00 02	Engine guard		<b>AN 400 Burgman (2017-)</b>			506334 00 01	Tank ring Lock-it	907	Our tank ring Lock-it 50609-7/8 / Basic 51609-7/8 fits all SUZUKI models with 7 or 8 hole mounting.		
611330 00 02	Sissybar with Rack	59	6523539 01 01	Alurack		516334 00 01	Tank ring Basic	707	506009-7/8	Tank ring Lock-it 7/8 hole	
600330 00 02	Sissybar without Rack	59	6613539 01 01	Easyrack		<b>GS 500/550 E/EC (1979-1982)</b>			516009-7/8	Tank ring Basic 7/8 hole	
611316 00 02	Solorack with Pad	59	42113539 00 91	Side stand enlargement		650306 00 01	Complete carrier	16	516009-7/8	Tank ring Basic 7/8 hole	
600316 00 02	Solorack without Pad	59									
400330 00 02	Twinlight Set										



**ATTENTION: You can find the new 2024 models online at [www.hepco-becker.de](http://www.hepco-becker.de)**



Item-no.	Description	Infos	Item-no.	Description	Infos	Item-no.	Description	Infos	Item-no.	Description	Infos
<b>RF 600 R (1993-1994)</b>			<b>GSX 600 E/F (1987-1997)</b>			<b>DR 650 RSE (1990-1996)</b>			<b>GR 650 E (1983-1985)</b>		
650371 00 01	Side carrier	5: A,B, C,D,E,F	650344 00 01	Complete carrier	5: A,B, C,D,E,F	650352 00 01	Side carrier		650309 00 02	Complete carrier	
650371 01 01	Rear rack		650344 01 01	Rear rack	13	650352 01 01	Rear rack	9, 3:B	<b>GS 650 G Katana (1981-1984)</b>		
506371 00 01	Tank ring Lock-it	908	506344 00 01	Tank ring Lock-it	908	502302 00 01	Engine guard		650312 00 01	Complete carrier	
516371 00 01	Tank ring Basic	708	516344 00 01	Tank ring Basic	708	<b>DR 650 R (1991)</b>			650312 01 01	Rear rack	22
<b>RF 600 R (1995-1997)</b>			<b>GSX 600 F (1998-2002)</b>			650364 00 01 Side carrier 0			<b>GSF 650 / S Bandit with ABS (2005-2006)</b>		
650379 01 01	Rear rack		650391 00 01	Side carrier		650364 01 01 Rear rack 9			6503508 00 01 Side carrier		
506379 00 01	Tank ring Lock-it	907	650391 01 01	Rear rack		502300 00 01 Engine guard			6503508 01 01 Alurack		
516379 00 01	Tank ring Basic	707	506391 00 01	Tank ring Lock-it	908	<b>DR 650 R (1992)</b>			6613508 01 01 Easyrack		
<b>GSF 600 S/N (1995)</b>			516391 00 01 Tank ring Basic 708			650365 00 01 Side carrier 0			6303513 00 01 C-Bow Holder		
650376 00 01	Complete carrier	3:D	<b>GSX-R 600 (2001-2003)</b>			650365 01 01 Rear rack 9			501319 00 01 Engine guard		
650376 01 01	Rear rack	22	650399 01 01 Rear rack			502304 00 01 Engine guard			5063508 00 01 Tank ring Lock-it 908		
506376 00 01	Tank ring Lock-it	907	506399 00 01 Tank ring Lock-it 908			<b>DR 650 SE (1996-2000)</b>			5163508 00 01 Tank ring Basic 708		
516376 00 01	Tank ring Basic	707	516399 00 01 Tank ring Basic 708			650381 00 01 Complete carrier 0, 91			<b>GSF 650 / S Bandit without ABS (2005-2006)</b>		
<b>GSF 600 S/N Bandit (1996-1999)</b>			<b>GSX-R/E 600 (2004-2005)</b>			650381 01 01 Rear rack			6503505 00 01 Side carrier		
650383 00 01	Complete carrier	3:D	6503502 01 01 Rear rack			502305 00 01 Engine guard			6503505 01 01 Alurack		
650383 01 01	Rear rack	22	5063502 00 01 Tank ring Lock-it 908			<b>LS 650 (-1996)</b>			6613505 01 01 Easyrack		
501306 00 01	Engine guard		5163502 00 01 Tank ring Basic 708			650357 00 02 Complete carrier 48			6303513 00 01 C-Bow Holder		
506383 00 01	Tank ring Lock-it	907	<b>GSX-R 600 (2008-2010)</b>			650357 01 02 Rear rack 13,59			501319 00 01 Engine guard		
516383 00 01	Tank ring Basic	707	670302 00 01 Sportrack 52			625357 00 02 Leather bag holder tube type			5063505 00 01 Tank ring Lock-it 908		
501306 00 02	Engine guard		506302 00 01 Tank ring Lock-it 908			501302 00 02 Engine guard			5163505 00 01 Tank ring Basic 708		
<b>GSF 600 S Bandit (2000-2004)</b>			516302 00 01 Tank ring Basic 708			600307 00 02 Sissybar without Rack 59					
650321 00 01	Side carrier		<b>GSX-R 600 (2011-)</b>			400357 00 02 Twinlight Set					
650321 01 01	Alurack		670304 00 01 Sportrack 52			<b>LS 650 (1997-2000)</b>					
661321 01 01	Easyrack		506304 00 01 Tank ring Lock-it 908			650389 00 02 Complete carrier 48					
630321 00 01	C-Bow Holder		516304 00 01 Tank ring Basic 708			650389 01 02 Rear rack 13,59					
501321 00 02	Engine guard		<b>Burgman AN 650 (2004-2012)</b>			625357 00 02 Leather bag holder tube type					
506321 00 01	Tank ring Lock-it	907	650374 01 01 Rear rack			501302 00 02 Engine guard					
516321 00 01	Tank ring Basic	707	<b>AN 650 Burgman (2013-)</b>			600307 00 02 Sissybar without Rack 59					
<b>GSR 600 (2006-2011)</b>			6503529 01 01 Alurack			400357 00 02 Twinlight Set					
6503510 00 01	Side carrier		6613529 01 01 Easyrack			<b>XF 650 Freewind (1997-2002)</b>					
6503510 01 01	Rear rack		<b>DR 650 RS (1990-1991)</b>			650387 00 01 Side carrier 0					
501324 00 01	Engine guard		650352 00 01 Side carrier			650387 01 01 Rear rack 9					
5063510 00 01	Tank ring Lock-it	908	650352 01 01 Rear rack 9, 3:B			506387 00 01 Tank ring Lock-it 907					
5163510 00 01	Tank ring Basic	708	502301 00 01 Engine guard			516387 00 01 Tank ring Basic 707					
			502302 00 01 Engine guard			502306 00 01 Engine guard					

### NOTICE Tank rings SUZUKI

Our tank ring Lock-it 506010-5 / Basic 516010-5 fits all SUZUKI models with 5 hole mounting.

506010-5 Tank ring Lock-it 5 hole

516010-5 Tank ring Basic 5 hole

Our tank ring Lock-it 50609-7/8 / Basic 51609-7/8 fits all SUZUKI models with 7 or 8 hole mounting.

506009-7/8 Tank ring Lock-it 7/8 hole

516009-7/8 Tank ring Basic 7/8 hole



**ATTENTION: You can find the new 2024 models online at [www.hepco-becker.de](http://www.hepco-becker.de)**



Info reference see p. 271

The last digit of the item-no. refers to the colours: 01= black 02= chrome 03= white 04= red 05= anthracite 06= orange 08= yellow 09= silver 10= blue metallic 12= Alu brushed 22= Stainless steel 91= silver/black

Item-no.	Description	Infos
<b>GSF 650 / S Bandit ABS (2007-2008)</b>		
6503512 00 01	Side carrier Lock-it	
6503512 01 01	Alurack	
6613512 01 01	Easyrack	
6303513 00 01	C-Bow Holder	
501325 00 01	Engine guard	
5033512 00 01	Front guard	
5043512 00 01	Rear guard	
5063512 00 01	Tank ring Lock-it	908
5163512 00 01	Tank ring Basic	708
<b>GSF 650 / S Bandit (2009-2012)</b>		
6503522 00 01	Side carrier Lock-it	135
6503522 01 01	Alurack	
6613522 01 01	Easyrack	
6303522 00 01	C-Bow Holder	135
501325 00 01	Engine guard	
<b>GSF 650 N Bandit (2010-)</b>		
5033513 00 01	Front guard	
<b>GSX 650 F (2008-)</b>		
6503517 00 01	Side carrier Lock-it	
6503517 01 01	Alurack	
6613517 01 01	Easyrack	
6303517 00 01	C-Bow Holder	
5063517 00 01	Tank ring Lock-it	908
5163517 00 01	Tank ring Basic	708
<b>SV 650/S (1999-2002)</b>		
650395 00 01	Side carrier	
650395 01 01	Rear rack	
501316 00 01	Engine guard	
506395 00 01	Tank ring Lock-it	908
516395 00 01	Tank ring Basic	708
<b>SV 650/S (2003-2006)</b>		
650354 00 01	Side carrier	31
650354 01 01	Rear rack	31
501354 00 01	Engine guard	
506354 00 01	Tank ring Lock-it	908
516354 00 01	Tank ring Basic	708

Item-no.	Description	Infos
<b>SV 650 X (2018-)</b>		
6503542 00 01	Side carrier Lock-it	
6523542 01 01	Alurack	
6613542 01 01	Easyrack	
6603542 01 01	Minirack	
6303542 00 01	C-Bow Holder	
5013542 00 01	Engine guard	
5063542 00 01	Tank ring Lock-it	908
5163542 00 01	Tank ring Basic	708
<b>SVF 650 Gladius (2009-2016)</b>		
6503521 00 01	Side carrier Lock-it	
6503521 01 01	Alurack	
6613521 01 01	Easyrack	
6303521 00 01	C-Bow Holder	
5013521 00 01	Engine guard	
5033521 00 01	Front guard	
5043521 00 01	Rear guard	
5063521 00 01	Tank ring Lock-it	908
5163521 00 01	Tank ring Basic	708
<b>SV 650 (2016-)</b>		
6503532 00 01	Side carrier Lock-it	
6523532 01 01	Alurack	
6613532 01 01	Easyrack	
6603532 01 01	Minirack	
6303532 00 01	C-Bow Holder	
5013532 00 01	Engine guard	
5033532 00 01	Front guard	
5063532 00 01	Tank ring Lock-it	908
5163532 00 01	Tank ring Basic	708

Item-no.	Description	Infos
<b>DL 650 V-Strom (2004-2011)</b>		
6503515 00 01	Side carrier Lock-it	0
6503515 01 01	Alurack	9
6613515 01 01	Easyrack	
6303515 00 01	C-Bow Holder	
800368 00 09	Rear rack enlargement	
810368 00 09	Skid plate	
810368 00 01	Skid plate	
731107	LED auxiliary headlights Nova	133
502308 00 01	Engine guard	
640100 00 01	Crash bar bag set V1	
5053501 00 01	Center stand	
506308 00 01	Tank ring Lock-it	907
516308 00 01	Tank ring Basic	707
42113515 00 91	Side stand enlargement	
<b>V-Strom 650 ABS (L2) / XT (2012-2016)</b>		
6503528 00 01	Side carrier Lock-it	0
6513528 00 22	Cutout Carrier	4:C3,C4
6513528 00 22-00-40	Xplorer Cutout Set	
6513528 00 22-01-40	Xplorer Cutout Set black	
6503528 01 01	Alurack	9
6613528 01 01	Easyrack	
6303528 00 01	C-Bow Holder	
8003528 00 01	Rear rack enlargement	
8103528 00 01	Skid plate	
8103528 00 09	Skid plate	
502309 00 01	Engine guard	
641309 00 01	Crash bar bag set V1	
5053528 00 01	Center stand	
506309 00 01	Tank ring Lock-it	908
516309 00 01	Tank ring Basic	708
42113528 00 91	Side stand enlargement	

Item-no.	Description	Infos
<b>V-Strom 650 / XT (2017-)</b>		
6503534 00 01	Side carrier Lock-it	55,142
6303534 00 01	C-Bow Holder	
6553534 01 01	Alurack f. Original rack	142
6623534 01 01	Easyrack f. Original rack	142
5053534 00 01	Center stand	
8103534 00 01	Skid plate	
8103534 00 12	Skid plate	
8003534 00 01	Rear rack enlargement	
5063534 00 01	Tank ring Lock-it	908
5163534 00 01	Tank ring Basic	708
5013534 00 01	Engine guard	
640100 00 01	Crash bar bag set V1	
42103534 00 01	Support brace for Rear rack	
42113534 00 91	Side stand enlargement	
7003534 00 01	Headlight grille	112
<b>DR BIG 750 (1988)</b>		
650345 00 01	Side carrier	0
650345 01 01	Rear rack	9, 3:B

### NOTICE Tank rings SUZUKI

Our tank ring Lock-it 506010-5 / Basic 516010-5 fits all SUZUKI models with 5 hole mounting.

506010-5 Tank ring Lock-it 5 hole

516010-5 Tank ring Basic 5 hole

Our tank ring Lock-it 50609-7/8 / Basic 51609-7/8 fits all SUZUKI models with 7 or 8 hole mounting.

506009-7/8 Tank ring Lock-it 7/8 hole

516009-7/8 Tank ring Basic 7/8 hole



**ATTENTION: You can find the new 2024 models online at [www.hepco-becker.de](http://www.hepco-becker.de)**





Item-no.	Description	Infos
<b>GSR 750 (2011-2016)</b>		
6503526 00 01	Side carrier Lock-it	
6503526 01 01	Alurack	
6613526 01 01	Easyrack	
6303526 00 01	C-Bow Holder	
6703526 00 01	Sportrack	52
5013526 00 01	Engine guard	
5063526 00 01	Tank ring Lock-it	908
5163526 00 01	Tank ring Basic	708
42113526 00 91	Side stand enlargement	
<b>GSX 750 S Katana (1980-1984)</b>		
650311 00 01	Complete carrier	
650311 01 01	Rear rack	22
506311 00 01	Tank ring Lock-it	907
516311 00 01	Tank ring Basic	707
<b>GSX 750 E (1979-1982)</b>		
650315 00 01	Complete carrier	16
650315 01 01	Rear rack	
<b>GSX 750 EF (1983-1988)</b>		
650319 00 01	Complete carrier	17
<b>GSX 750 ES (1983-1988)</b>		
650319 00 01	Complete carrier	17
<b>GSX 750 F (1989-1997)</b>		
650349 00 01	Complete carrier	
650349 01 01	Rear rack	27

Item-no.	Description	Infos
<b>GSX 750 F (1998-2002)</b>		
650394 00 01	Side carrier	
650394 01 01	Rear rack	
506394 00 01	Tank ring Lock-it	907
516394 00 01	Tank ring Basic	707
<b>GSX 750 F (2003-2006)</b>		
650396 00 01	Side carrier	
650396 01 01	Rear rack	
506396 00 01	Tank ring Lock-it	908
516396 00 01	Tank ring Basic	708
<b>GSX 750 (1998-2003)</b>		
650390 00 01	Side carrier	
650390 01 01	Rear rack	
501313 00 02	Engine guard	
506390 00 01	Tank ring Lock-it	908
516390 00 01	Tank ring Basic	708
<b>GSX-R 750 (1988-1990)</b>		
650347 00 01	Side carrier	5: A,B, C,D,E,F
650347 01 01	Rear rack	13
<b>GSX-R 750 (1991-)</b>		
650359 01 01	Rear rack	13
506359 00 01	Tank ring Lock-it	907
516359 00 01	Tank ring Basic	707
<b>GSX-R 750 (1992-)</b>		
650363 00 01	Side carrier	5: A,B, C,D,E,F
650363 01 01	Rear rack	
506363 00 01	Tank ring Lock-it	907
516363 00 01	Tank ring Basic	707
<b>GSX-R 750 (2000-2003)</b>		
650399 01 01	Rear rack	
506399 09 01	Tank ring Lock-it	908
516399 09 01	Tank ring Basic	708
<b>GSX-R 750 (2004-2005)</b>		
6503502 01 01	Rear rack	
5063502 00 01	Tank ring Lock-it	908
5163502 00 01	Tank ring Basic	708

Item-no.	Description	Infos
<b>GSX-R 750 (2011-)</b>		
670304 00 01	Sportrack	52
506304 00 01	Tank ring Lock-it	
516304 00 01	Tank ring Basic	
<b>GSX-R 750 W (1992-1995)</b>		
650369 00 01	Side carrier	5: A,B, C,D,E,F
650369 01 01	Rear rack	
506304 00 01	Tank ring Lock-it	907
516304 00 01	Tank ring Basic	707
<b>GSX-R 750 W (1994-1995)</b>		
650373 00 01	Side carrier	5: A,B, C,D,E,F
650373 01 01	Rear rack	
<b>GSX-R 750 (1996-1997)</b>		
650384 01 01	Rear rack	
506384 00 01	Tank ring Lock-it	907
516384 00 01	Tank ring Basic	707
<b>GSX-R 750 (2008-2010)</b>		
670301 00 01	Sportrack	52
506304 00 01	Tank ring Lock-it	907
516304 00 01	Tank ring Basic	707
<b>GSX-S 750 (2017-)</b>		
6303540 00 01	C-Bow Holder	
6703540 00 01	Sportrack	52
5063540 00 01	Tank ring Lock-it	908
5163540 00 01	Tank ring Basic	708
5013540 00 01	Engine guard incl. Protectionpad	
42113540 00 91	Side stand enlargement	
<b>VS 750 Intruder (1986-1991)</b>		
625367 00 02	Leather bag holder tube type	3:P,S
400367 00 02	Twinlight Set	
501303 00 02	Engine guard	

Item-no.	Description	Infos
<b>VS 800 GL / GLP Intruder (1992-2000)</b>		
650367 00 02	Complete carrier	48
650367 01 02	Rear rack	
625367 00 02	Leather bag holder tube type	3:P,S
501303 00 02	Engine guard	
611309 00 02	Sissybar with Rack	59
600309 00 02	Sissybar without Rack	59
400367 00 02	Twinlight Set	
<b>DR BIG 800 (1989-1990)</b>		
650350 00 01	Side carrier	0
650350 01 01	Rear rack	9, 3:B
<b>DR BIG 800 (1991-1997)</b>		
650360 00 01	Side carrier	
650360 01 01	Rear rack	9, 3:B
502303 00 01	Engine guard	
<b>DR BIG (1992-)</b>		
650366 00 01	Side carrier	
650366 01 01	Rear rack	9, 3:B
502303 00 01	Engine guard	
<b>C 800 Intruder / Black Edition (2005-)</b>		
650338 00 01	Side carrier	
650338 00 02	Side carrier	
650338 01 01	Rear rack	
650338 01 02	Rear rack	
630338 00 01	C-Bow Leather bag holder	
630338 00 02	C-Bow Leather bag holder	
625338 00 02	Leather bag holder tube type	
501340 00 01	Engine guard	
501340 00 02	Engine guard	
611338 00 02	Sissybar with Rack	59
611338 00 01	Sissybar with Rack	59
600338 00 02	Sissybar without Rack	59
600338 00 01	Sissybar without Rack	59
611317 00 02	Solorack with Pad	59
600317 00 02	Solorack without Pad	59
400340 00 02	Twinlight Set	

## NOTICE Tank rings SUZUKI

Our tank ring Lock-it 506010-5 / Basic 516010-5 fits all SUZUKI models with 5 hole mounting.

506010-5 Tank ring Lock-it 5 hole

516010-5 Tank ring Basic 5 hole

Our tank ring Lock-it 50609-7/8 / Basic 51609-7/8 fits all SUZUKI models with 7 or 8 hole mounting.

506009-7/8 Tank ring Lock-it 7/8 hole

516009-7/8 Tank ring Basic 7/8 hole



**ATTENTION: You can find the new 2024 models online at [www.hepco-becker.de](http://www.hepco-becker.de)**



Info reference see p. 271

The last digit of the item-no. refers to the colours: 01= black 02= chrome 03= white 04= red 05= anthracite 06= orange 08= yellow 09= silver 10= blue metallic 12= Alu brushed 22= Stainless steel 91= silver/black

Item-no.	Description	Infos	Item-no.	Description	Infos	Item-no.	Description	Infos	Item-no.	Description	Infos
<b>GSX 8S (2023-)</b>			<b>VL 800 Intruder LC Volusia (-2008)</b>			<b>V-Strom 800 DE (2023-)</b>			<b>VZ 800 Marauder (1996-2003)</b>		
6303551 00 01	C-Bow holder		650338 00 02	Side carrier		6513548 00 01-00-40	Xplorer Cutout Set		650386 00 02	Side carrier	
6523551 01 01	Alurack		650338 01 02	Rear rack		6513548 00 01-01-40	Xplorer Cutout Set Black		650386 01 02	Rear rack	
6613551 01 01	Easyrack		650338 01 01	Rear rack		6513548 00 01	Cutout carrier		625386 00 02	Leather bag holder tube type	
6603551 01 01	Minirack		630338 00 02	C-Bow Leather bag holder		6303548 00 01	C-Bow holder	3H; 178	501310 00 02	Engine guard	
6703551 00 01	Sportrack		625338 00 02	Leather bag holder tube type		6523548 01 01	Alurack		611310 00 02	Sissybar with Rack	59
5163551 00 01	Tank ring Basic	708; 3-L4, L5,U5	501338 00 02	Engine guard		6613548 01 01	Easyrack		600310 00 02	Sissybar without Rack	59
5063551 00 01	Tank ring Lock-it	908; 3-L4, L5,U5	611338 00 02	Sissybar with Rack	59	6603548 01 01	Minirack		611311 00 02	Solorack with Pad	59
5013551 00 01	Engine guard		600338 00 02	Sissybar without Rack	59	8003548 00 01	Rear rack enlargement		600311 00 02	Solorack without Pad	59
5013551 00 07	Engine guard		611317 00 02	Solorack with Pad	59	5063548 00 01	Tank ring Lock-it	908	400386 00 02	Twinlight Set	
5033551 00 01	Front guard		600317 00 02	Solorack without Pad	59	5163548 00 01	Tank ring Basic	708	<b>RF 900 R/RF 900 RS 2 (1994-1997)</b>		
42113551 00 91	Side stand enlargement		400338 00 02	Twinlight Set		5013548 00 01	Engine guard	119	650372 00 01	Side carrier	
<b>M 800 Intruder (2005-2009)</b>			<b>VL 800 Intruder LC Volusia (2009-)</b>			5023548 00 01	Tank guard		650372 01 01	Rear rack	
6503506 00 02	Side carrier		650343 00 02	Side carrier		8103548 00 01	Skid plate		506372 00 01	Tank ring Lock-it	908
6503506 01 02	Rear rack		650343 01 02	Rear rack		8103548 00 12	Skid plate		516372 00 01	Tank ring Basic	708
6303506 00 02	C-Bow Leather bag holder		650338 01 01	Rear rack		42123548 00 01	Handle guard		<b>GSX-S 950 / 1000 (2021-)</b>		
6253506 00 02	Leather bag holder tube type		630338 00 02	C-Bow Leather bag holder		731107	LED auxiliary headlights Nova	133	6303546 00 01	C-Bow holder	
501320 00 02	Engine guard		625338 00 02	Leather bag holder tube type		640100 00 01	Crash bar bag set V1		6703546 00 01	Sportrack	
611319 00 02	Sissybar with Rack	59	501338 00 02	Engine guard		5053548 00 01	Center stand		42113546 00 91	Side stand enlargement	
600319 00 02	Sissybar without Rack	59	611338 00 02	Sissybar with Rack	59	42113548 00 91	Side stand enlargement		5063546 00 01	Tank ring Lock-it	908
611320 00 02	Solorack with Pad	59	611338 00 01	Sissybar with Rack	59	<b>VX 800 (1990-1997)</b>			5163546 00 01	Tank ring Basic	708
600320 00 02	Solorack without Pad	59	600338 00 02	Sissybar without Rack	59	650353 00 02	Complete carrier		<b>SV 1000/S (2003-2005)</b>		
4003506 00 02	Twinlight Set		600338 00 01	Sissybar without Rack	59	650353 01 02	Rear rack		650377 00 01	Side carrier	31
<b>M 800 Intruder (2010-)</b>			611317 00 02	Solorack with Pad	59	506353 00 01	Tank ring Lock-it	907	650377 01 01	Rear rack	31
6503524 00 02	Side carrier		600317 00 02	Solorack without Pad	59	516353 00 01	Tank ring Basic	707	506377 00 01	Tank ring Lock-it	908
6503524 01 02	Rear rack		400338 00 02	Twinlight Set		501304 00 02	Engine guard		516377 00 01	Tank ring Basic	708
6303524 00 02	C-Bow Leather bag holder								<b>NOTICE Tank rings SUZUKI</b>		
5013524 00 02	Engine guard								Our tank ring Lock-it 506010-5 / Basic 516010-5 fits all SUZUKI models with 5 hole mounting.		
6113524 00 02	Sissybar with Rack	59							506010-5	Tank ring Lock-it 5 hole	
6003524 00 02	Sissybar without Rack	59							516010-5	Tank ring Basic 5 hole	
4003524 00 02	Twinlight Set								Our tank ring Lock-it 50609-7/8 / Basic 51609-7/8 fits all SUZUKI models with 7 or 8 hole mounting.		
									506009-7/8	Tank ring Lock-it 7/8 hole	
									516009-7/8	Tank ring Basic 7/8 hole	

**ATTENTION: You can find the new 2024 models online at [www.hepco-becker.de](http://www.hepco-becker.de)**



Item-no.	Description	Infos
<b>TL 1000 S (1998-2000)</b>		
650385 01 01	Rear rack	
506385 00 01	Tank ring Lock-it	907
516385 00 01	Tank ring Basic	707
<b>GS 1000 E (1978-1980)</b>		
650325 00 02	Complete carrier	
<b>GSX-R 1000 (-2003)</b>		
650399 01 01	Rear rack	
506399 03 01	Tank ring Lock-it	908
516399 03 01	Tank ring Basic	708
<b>GSX-1000 R (2005-2008)</b>		
630303 00 01	Lock-it C-Bow Holder (2007-2008)	
670303 00 01	Sportrack	52
506303 00 01	Tank ring Lock-it	908
516303 00 01	Tank ring Basic	708
<b>GSX-R 1000 (2009-2011)</b>		
670399 00 01	Sportrack	52
506399 02 01	Tank ring Lock-it	908
516399 02 01	Tank ring Basic	708
<b>GSX-R 1000 (2012-2016)</b>		
670305 00 01	Sportrack	52
506305 00 01	Tank ring Lock-it	908
516305 00 01	Tank ring Basic	708
<b>GSX-R 1000 / R (2017-)</b>		
6703541 00 01	Sportrack	52
5063541 00 01	Tank ring Lock-it	908
5163541 00 01	Tank ring Basic	708

## NOTICE Tank rings SUZUKI

Our tank ring Lock-it 506010-5 / Basic 516010-5 fits all SUZUKI models with 5 hole mounting.

506010-5 Tank ring Lock-it 5 hole

516010-5 Tank ring Basic 5 hole

Our tank ring Lock-it 50609-7/8 / Basic 51609-7/8 fits all SUZUKI models with 7 or 8 hole mounting.

506009-7/8 Tank ring Lock-it 7/8 hole

516009-7/8 Tank ring Basic 7/8 hole

Item-no.	Description	Infos
<b>GSX-S 1000 / F ABS (2015-2020)</b>		
6303531 00 01	C-Bow Holder	
6703531 00 01	Sportrack	52
5063531 00 01	Tank ring Lock-it	908
5163531 00 01	Tank ring Basic	708
42113531 00 91	Side stand enlargement	
<b>GSX-S 1000 S Katana (2019-)</b>		
5063543 00 01	Tank ring Lock-it	908
5163543 00 01	Tank ring Basic	708
42113543 00 91	Side stand enlargement	
<b>GSX-S 1000 GT / Travel Edition (2022-)</b>		
6303547 00 01	C-Bow holder	88
6523547 01 01	Alurack	56
6613547 01 01	Easyrack	56
6603547 01 01	Minirack	56
5063547 00 01	Tank ring Lock-it	908
5163547 00 01	Tank ring Basic	708
5073547 00 01	Protection Pad	
42113547 00 91	Side stand enlargement	
<b>DL 1000 V-Strom (2002-2007)</b>		
6503520 00 01	Side carrier Lock-it	
6503520 01 01	Alurack	9
6613520 01 01	Easyrack	
502307 00 01	Engine guard	
505368 00 01	Center stand	
800368 00 09	Rear rack enlargement	
5063520 00 01	Tank ring Lock-it	907
5163520 00 01	Tank ring Basic	707

Item-no.	Description	Infos
<b>V-Strom 1000 / XT ABS (2014-2019)</b>		
6503530 00 01	Side carrier Lock-it	
6503530 01 01	Alurack	
42103530 00 01	Support brace for Alurack	
6613530 01 01	Easyrack	
6303530 00 01	C-Bow Holder	
5013530 00 01	Engine guard	
5023530 00 01	Tank guard (2014-2016)	65
5023535 00 01	Tank guard (2017-)	65
6413530 00 01	Crash bar bag set V1	
7311107	LED auxiliary headlights Nova	133
8103530 00 09	Skid plate	
5053530 00 01	Center stand	
8003530 00 01	Rear rack enlargement	
7003530 00 01	Headlight grille	112, 116
700008551	Holding adapter for mounting of headlight grilles 7003530	
7003535 00 01	Headlight grille (2017-)	112, 116
700009687	Holding adapter for mounting of headlight grilles 7003535	
4203530-01	Handle guard (2017-)	83, 224
5063530 00 01	Tank ring Lock-it	908
5163530 00 01	Tank ring Basic	708
42113530 00 91	Side stand enlargement	

Item-no.	Description	Infos
<b>V-Strom 1050 (2023-)</b>		
6533550 00 01	Side carrier	
6303550 00 01	C-Bow holder	3H, 178
5063550 00 01	Tank ring Lock-it	
5163550 00 01	Tank ring Basic	
6553550 01 01	Alurack f. original rack	
6623550 01 01	Easyrack f. original rack	
8003550 00 01	Rear rack enlargement	
42103550 00 01	Support brace f. original rack	
5013550 00 01	Engine guard	
8103550 00 12	Skid plate	
42123550 00 01	Handle guard	
7311107	LED auxiliary headlights Nova	133
640100 00 01	Crash bar bag set V1	
7003550 00 01	Headlight grille	
42113550 00 91	Side stand enlargement	
<b>V-Strom 1050 DE (2023-)</b>		
6533549 00 01	Side carrier	
6303549 00 01	C-Bow holder	3H, 178
5063549 00 01	Tank ring Lock-it	
5163549 00 01	Tank ring Basic	
6553549 01 01	Alurack f. original rack	
6623549 01 01	Easyrack f. original rack	
8003549 00 01	Rear rack enlargement	
42103549 00 01	Support brace f. original rack	
5023549 00 01	Tank guard	
42123549 00 01	Handle guard	
7311107	LED auxiliary headlights Nova	133
640100 00 01	Crash bar bag set V1	
7003549 00 01	Headlight grille	
42113549 00 91	Side stand enlargement	



**ATTENTION: You can find the new 2024 models online at [www.hepco-becker.de](http://www.hepco-becker.de)**



Info reference see p. 271

The last digit of the item-no. refers to the colours: 01= black 02= chrome 03= white 04= red 05= anthracite 06= orange 08= yellow 09= silver 10= blue metallic 12= Alu brushed 22= Stainless steel 91= silver/black

Item-no.	Description	Infos
<b>V-Strom 1050 / XT (2020-2022)</b>		
6503544 00 01	Side carrier Lock-it	224
6533544 00 01	Side carrier	
6553544 01 01	Alurack f. Original rack	142
6623544 01 01	Easyrack f. Original rack	142
8003544 00 01	Rear rack enlargement	
42103544 00 01	Support brace f. Original rack	122
6303544 00 01	C-Bow Holder	224
5013544 00 01	Engine guard	224
640100 00 01	Crash bar bag set V1	224
731107	LED auxiliary headlights Nova	133
8103544 00 12	Skid plate	224
8113544 00 12	Skid plate	94,225
8113544 00 01	Skid plate	94,225
5053544 00 01	Center stand	224
7003544 00 01	Headlight grille	112
42123544 00 01	Handle guard	226
5063544 00 01	Tank ring Lock-it	908
5163544 00 01	Tank ring Basic	708
42113544 00 91	Side stand enlargement	
<b>GSX 1100 E (1980-1982)</b>		
650315 00 01	Complete carrier	16
<b>GSX 1100 ES (1982-1983) (2 FB)</b>		
650320 00 01	Complete carrier	16
650320 01 01	Rear rack	
<b>GSX 1100 ES / EF (1983-1986) (ZFB)</b>		
650331 00 01	Complete carrier	17
<b>GSX 1100 F (1988-1994)</b>		
650356 00 01	Complete carrier	18
650356 01 01	Rear rack	22
<b>GSX 1100 G (1991-1996)</b>		
650361 00 02	Complete carrier	
650361 01 01	Rear rack	22
506361 00 01	Tank ring Lock-it	907
516361 00 01	Tank ring Basic	707

Item-no.	Description	Infos
<b>GSX 1100 R (1991-1992)</b>		
650362 00 01	Side carrier	5: A,B,C,D,E,F
650362 01 01	Rear rack	13
506362 00 01	Tank ring Lock-it	907
516362 00 01	Tank ring Basic	707
<b>GSX-R 1100 W (1993-1994)</b>		
650370 00 01	Side carrier	
650370 01 01	Rear rack	13
506370 00 01	Tank ring Lock-it	907
516370 00 01	Tank ring Basic	707
<b>GSX-R 1100 W (1995-1997)</b>		
650380 01 01	Rear rack	13
<b>GSF 1200 S/N Bandit (1996-2000)</b>		
650382 00 01	Complete carrier	
650382 01 01	Rear rack	22
501309 00 01	Engine guard	
501309 00 02	Engine guard	
506382 00 01	Tank ring Lock-it	907
516382 00 01	Tank ring Basic	707
<b>GSF 1200 / S Bandit (2001-2005)</b>		
650322 00 01	Side carrier	
650322 01 01	Alurack	
661322 01 01	Easyrack	
630322 00 01	C-Bow Holder	
501315 00 02	Engine guard	
506322 00 01	Tank ring Lock-it	907
516322 00 01	Tank ring Basic	707
<b>GSF 1200 / S Bandit (2006)</b>		
6503509 00 01	Side carrier	
6503509 01 01	Alurack	
6613509 01 01	Easyrack	
6303509 00 01	C-Bow Holder	
501323 00 02	Engine guard	
5063509 00 01	Tank ring Lock-it	907
5163509 00 01	Tank ring Basic	707

Item-no.	Description	Infos
<b>GSF 1250 / S Bandit (2007-2016)</b>		
6503513 00 01	Side carrier Lock-it	78
6503522 00 01	Side carrier for ABS model (2010-)	135
6503513 01 01	Alurack	
6613513 01 01	Easyrack	
6303513 00 01	C-Bow Holder	
6303522 00 01	C-Bow Holder	135
501326 00 01	Engine guard	
5063513 00 01	Tank ring Lock-it	908
5163513 00 01	Tank ring Basic	708
<b>GSX 1200 (1999-2000)</b>		
650393 00 01	Side carrier	
650393 01 01	Rear rack	
506393 00 01	Tank ring Lock-it	907
516393 00 01	Tank ring Basic	707
501315 00 02	Engine guard	
<b>GSX 1250 FA (2010-) / SA (2015-)</b>		
6503523 00 01	Side carrier Lock-it	
6503523 01 01	Alurack	
6613523 01 01	Easyrack	
6303523 00 01	C-Bow Holder	
5063523 00 01	Tank ring Lock-it	908
5163523 00 01	Tank ring Basic	708
<b>GSX 1300 R Hayabusa (1999-2007)</b>		
650398 00 01	Side carrier	
650398 01 01	Rear rack	
506398 00 01	Tank ring Lock-it	907
516398 00 01	Tank ring Basic	707
<b>GSX 1300 R Hayabusa (2008-2020)</b>		
6503518 00 01	Side carrier Lock-it	
6503518 01 01	Alurack	
6613518 01 01	Easyrack	
5063518 00 01	Tank ring Lock-it	908
5163518 00 01	Tank ring Basic	708

Item-no.	Description	Infos
<b>GSX 1300 R Hayabusa (2021-)</b>		
6303545 00 01	C-Bow holder	3:H
5063545 00 01	Tank ring Lock-it	3:L5,L6
5163545 00 01	Tank ring Basic	3:L5,L6
6523545 01 01	Alurack	
6613545 01 01	Easyrack	
6603545 01 01	Minirack	
<b>B-King (2008-2011)</b>		
6503519 01 01	Alurack	
6613519 01 01	Easyrack	
6303519 00 01	C-Bow Holder	
5013519 00 01	Engine guard	
<b>GSX 1400 (2001-2004)</b>		
650329 00 01	Side carrier	42,90,3:C,D
650329 01 01	Alurack	
661329 01 01	Easyrack	
501329 00 02	Engine guard	
506329 00 01	Tank ring Lock-it	907
516329 00 01	Tank ring Basic	707
<b>GSX 1400 (2005-2006)</b>		
6503507 00 01	Side carrier	43
6503507 01 01	Alurack	43
6613507 01 01	Easyrack	43
501329 00 02	Engine guard	
5063507 00 01	Tank ring Lock-it	907
5163507 00 01	Tank ring Basic	707



**ATTENTION: You can find the new 2024 models online at [www.hepco-becker.de](http://www.hepco-becker.de)**

### NOTICE Tank rings SUZUKI

Our tank ring Lock-it 506010-5 / Basic 516010-5 fits all SUZUKI models with 5 hole mounting.

506010-5 Tank ring Lock-it 5 hole

516010-5 Tank ring Basic 5 hole

Our tank ring Lock-it 50609-7/8 / Basic 51609-7/8 fits all SUZUKI models with 7 or 8 hole mounting.

506009-7/8 Tank ring Lock-it 7/8 hole

516009-7/8 Tank ring Basic 7/8 hole



Item-no.	Description	Infos	Item-no.	Description	Infos	Item-no.	Description	Infos	Item-no.	Description	Infos
<b>VS 1400 Intruder (1987-1996)</b>			<b>C 1500 Intruder (2005-2007)</b>			<b>VL 1500 Intruder (1998-2004)</b>			<b>C 1800 R / T Intruder (VLR 1800) (2008-2010)</b>		
650340 00 02	Complete carrier		650392 00 02	Side carrier		650392 00 02	Side carrier		6503516 00 02	Side carrier	
650340 01 02	Rear rack	22,154	650392 01 02	Rear rack		650392 01 02	Rear rack		6503516 01 02	Rear rack	
650342 00 02	Complete carrier	48	625392 00 02	Leather bag holder tube type		625392 00 02	Leather bag holder tube type		6303516 00 02	C-Bow Leather bag holder	
650342 01 02	Rear rack	154	501312 00 02	Engine guard		501312 00 02	Engine guard		6253516 00 02	Leather bag holder tube type	
625342 00 02	Leather bag holder tube type	3:P,S	611312 00 02	Sissybar with Rack	59	611312 00 02	Sissybar with Rack	59	5013516 00 02	Engine guard	93
501305 00 02	Engine guard		600312 00 02	Sissybar without Rack	59	600312 00 02	Sissybar without Rack	59	6113516 00 02	Sissybar with Rack	59
611308 00 02	Sissybar with Rack	59	611313 00 02	Solorack with Pad	59	611313 00 02	Solorack with Pad	59	6003516 00 02	Sissybar without Rack	59
600308 00 02	Sissybar without Rack	59	600313 00 02	Solorack without Pad	59	600313 00 02	Solorack without Pad	59	6113517 00 02	Solorack with Pad	59
400342 00 02	Twinlight Set		410392 00 02	Fender Guard		410392 00 02	Fender Guard		6003517 00 02	Solorack without Pad	59
<b>VS 1400 Intruder (1997-2003)</b>			<b>C 1500 T Intruder (2013-)</b>			<b>M 1600 Intruder (2005)</b>			<b>C 1800 R / T Intruder (VLR 1800) (2011-2012)</b>		
650313 00 02	Complete carrier	48	650333 01 01	Rear rack		6503504 00 02	Side carrier		4103516 00 02	Fender Guard	
650313 01 02	Rear rack	22,154	501333 00 01	Engine guard		6503504 01 02	Rear rack		4003516 00 02	Twinlight Set	
625342 00 02	Leather bag holder tube type	3:P,S	611333 00 01	Sissybar with Rack		6253504 00 02	Leather bag holder tube type		<b>C 1800 R / T Intruder (VLR 1800) (2011-2012)</b>		
501305 00 02	Engine guard		600333 00 01	Sissybar without Rack		501318 00 02	Engine guard		6503527 00 02	Side carrier	
611308 00 02	Sissybar with Rack	59	611334 00 01	Solorack with Pad		611318 00 02	Sissybar with Rack	59	6503516 01 02	Rear rack	
600308 00 02	Sissybar without Rack	59	600334 00 01	Solorack without Pad		600318 00 02	Sissybar without Rack	59	6303516 00 02	C-Bow Leather bag holder	
400342 00 02	Twinlight Set		400333 00 01	Twinlight Set		4003504 00 02	Twinlight Set		6253527 00 02	Leather bag holder tube type	
<b>M 1500 (2009-)</b>			<b>M 1500 (2009-)</b>			<b>VZ 1600 Marauder (2004)</b>			<b>M 1800 (VZ) R Intruder (2006-)</b>		
650332 00 02	Side carrier		650332 00 02	Side carrier		6503504 00 02	Side carrier		5013516 00 02	Engine guard	93
650332 01 02	Rear rack		650332 01 02	Rear rack		6503504 01 02	Rear rack		6113516 00 02	Sissybar with Rack	59
630332 00 02	C-Bow Leather bag holder		630332 00 02	C-Bow Leather bag holder		6253504 00 02	Leather bag holder tube type		6003516 00 02	Sissybar without Rack	59
501332 00 02	Engine guard		501332 00 02	Engine guard		501318 00 02	Engine guard		6113517 00 02	Solorack with Pad	59
611332 00 02	Sissybar with Rack	59	611332 00 02	Sissybar with Rack	59	611318 00 02	Sissybar with Rack	59	6003517 00 02	Solorack without Pad	59
600332 00 02	Sissybar without Rack	59	600332 00 02	Sissybar without Rack	59	600318 00 02	Sissybar without Rack	59	4103516 00 02	Fender Guard	
400332 00 02	Twinlight Set		400332 00 02	Twinlight Set		4003504 00 02	Twinlight Set		4003516 00 02	Twinlight Set	
<b>NOTICE Tank rings SUZUKI</b>			<b>ATTENTION: You can find the new 2024 models online at <a href="http://www.hepco-becker.de">www.hepco-becker.de</a></b>								
Our tank ring Lock-it 506010-5 / Basic 516010-5 fits all SUZUKI models with 5 hole mounting.											
506010-5	Tank ring Lock-it 5 hole										
516010-5	Tank ring Basic 5 hole										
Our tank ring Lock-it 50609-7/8 / Basic 51609-7/8 fits all SUZUKI models with 7 or 8 hole mounting.											
506009-7/8	Tank ring Lock-it 7/8 hole										
516009-7/8	Tank ring Basic 7/8 hole										



Info reference see p. 271

The last digit of the item-no. refers to the colours: 01= black 02= chrome 03= white 04= red 05= anthracite 06= orange 08= yellow 09= silver 10= blue metallic 12= Alu brushed 22= Stainless steel 91= silver/black

Item-no.	Description	Info's
<b>Daytona 600 (2003-2004)</b>		
506001-6	Tankring Lock-it	
516001-6	Tankring Basic	
<b>Trident 660 (2021-)</b>		
6307612 00 01	C-Bow holder	
6527612 01 01	Alurack	
6617612 01 01	Easyrack	
6607612 01 01	Minirack	
6587612 01 01	Rear rack tube type	141
8107612 00 41	Belly pan	
8107612 00 91	Belly pan	
7007612 00 01	Headlight grilles	
5017612 00 01	Engine guard incl. Protectionpad	
5037612 00 01	Front guard	
5047612 00 01	Rear guard	
5067612 00 01	Tank ring Lock-it	900
5167612 00 01	Tank ring Basic	700
42117612 00 91	Side stand enlargement	
42197612 00 01	Pillion handle	
<b>Tiger Sport 660 (2022-)</b>		
6307636 00 01	C-Bow holder	
6557636 01 01	Alurack f. original rack	
6627636 01 01	Easyrack f. original rack	
8007636 00 01	Rear rack enlargement	
5017636 00 01	Engine guard	
5027636 00 01	Tank guard	129
42117636 00 91	Side stand enlargement	
5067636 00 01	Tank ring Lock-it	
5167636 00 01	Tank ring Basic	
5067636 00 01	Belly pan	
<b>Daytona 675 (2006-2012)</b>		
670709 00 01	Sportrack (-2012)	52
506709 00 01	Tankring Lock-it	900
516709 00 01	Tankring Basic	700

Item-no.	Description	Info's
<b>Daytona 675/R (2013-) / Street Triple RX (2015-)</b>		
6707545 00 01	Sportrack	52
5067545 00 01	Tankring Lock-it	900
5167545 00 01	Tankring Basic	700
<b>Street Triple 675 / R (2007-2012)</b>		
650794 01 01	Alurack	
661794 01 01	Easyrack	
630794 00 01	C-Bow holder	
670794 00 01	Lock-it Sportrack	52,169
501794 00 01	Engine guard	
506794 00 01	Tankring Lock-it	900
516794 00 01	Tankring Basic	700
<b>Street Triple 675 / R (2013-2016)</b>		
6507520 01 01	Alurack	
6617520 01 01	Easyrack	
6307520 00 01	C-Bow holder	
5017520 00 01	Engine guard	
5067520 00 01	Tankring Lock-it	900
5167520 00 01	Tankring Basic	700
<b>Street Triple 765 S / RS / R / R Low / Moto 2 (2017-)</b>		
6307573 00 01	C-Bow holder	
6707573 00 01	Sportrack	52
5067573 00 01	Tankring Lock-it	900
5167573 00 01	Tankring Basic	700
5077573 00 01	Protectionpad	
<b>Trident 750 (1992-1997)</b>		
650735 00 01	Complete carrier	
650735 01 01	Rear rack	22

Item-no.	Description	Info's
<b>Tiger 800 (2010-2014)</b>		
6507505 00 01	Side carrier Lock-it	0
6507505 01 01	Alurack	9
6617505 01 01	Easyrack	9
6307505 00 01	C-Bow holder	
5017505 00 01	Engine guard	
5027505 00 01	Tank guard	
8007505 00 01	Rear rack enlargement	
5057505 00 01	Center stand	
7007505 00 01	Headlight grilles	112,163
7007592 00 01	Headlight grilles	112,166
5067505 00 01	Tankring Lock-it	900
5167505 00 01	Tankring Basic	700
42117505 00 91	Side stand enlargement	180
<b>Tiger 800 XC (-2014)</b>		
6507505 00 01	Side carrier Lock-it	0
6507505 01 01	Alurack	9
6617505 01 01	Easyrack	9
6307505 00 01	C-Bow holder	
5017505 00 01	Engine guard	
5027505 00 01	Tank guard	
8007505 00 01	Rear rack enlargement	
5057506 00 01	Center stand	
7007505 00 01	Headlight grilles	112,163
731107	LED auxiliary headlights Nova	133
5067505 01 01	Tankring Lock-it	900
5167505 01 01	Tankring Basic	700
42117506 00 91	Side stand enlargement	180

Item-no.	Description	Info's
<b>Tiger 800 XC / XCX / A (2015-2019)</b>		
6507535 00 01	Side carrier Lock-it (-2017)	0
6507592 00 01	Side carrier Lock-it (2018-)	0
6507535 01 01	Alurack	9
6617535 01 01	Easyrack	9
6307535 00 01	C-Bow holder (-2017)	
6307592 00 01	C-Bow holder (2018-)	
5017535 00 01	Engine guard	
5027535 00 01	Tank guard (-2017)	
5027592 00 01	Tank guard (2018-)	
731107	LED auxiliary headlights Nova	133
8007535 00 01	Rear rack enlargement	
5057535 00 01	Center stand	
7007535 00 01	Headlight grilles	112,163
4207535-01	Handle guard (-2017)	
42127592 00 01	Handle guard (2018-)	
5067535 00 01	Tankring Lock-it	900
5167535 00 01	Tankring Basic	700
42117535 00 91	Side stand enlargement	180

## NOTICE Tank rings TRIUMPH

Our tank ring Lock-it 506001-6 / Basic 516001-6 fits all TRIUMPH models with 6 hole mounting.

506001-6	Tank ring Lock-it 6-hole
516001-6	Tank ring Basic 6-hole



**ATTENTION:** You can find the new 2024 models online at [www.hepco-becker.de](http://www.hepco-becker.de)



Item-no.	Description	Info's
<b>Tiger 800 XR / XRX / T (2015-2019)</b>		
6507536 00 01	Side carrier Lock-it (-2017)	0
6507592 00 01	Side carrier Lock-it (2018-)	0
6507536 01 01	Alurack	9
6617536 01 01	Easyrack	9
6307536 00 01	C-Bow holder (-2017)	
6307592 00 01	C-Bow holder (2018-)	
5017536 00 01	Engine guard	
5027536 00 01	Tank guard (-2017)	
5027592 00 01	Tank guard (2018-)	
731107	LED auxiliary headlights Nova	133
8007536 00 01	Rear rack enlargement	
5057536 00 01	Center stand	
7007536 00 01	Headlight grilles	112,163
4207536-01	Handle guard (-2017)	
42127592 00 01	Handle guard (2018-)	
5067536 00 01	Tankring Lock-it	900
5167536 00 01	Tankring Basic	700
42117536 00 91	Side stand enlargement	180,245

Item-no.	Description	Info's
<b>Tiger 850 Sport (2021-)</b>		
6537613 00 01	Side carrier	
6557613 01 01	Alurack f. Original rack	
6627613 01 01	Easyrack f. Original rack	
8007613 00 01	Rear rack enlargement	
6307613 00 01	C-Bow holder	
5017613 00 01	Engine guard	
5017613 00 03	Engine guard	
5017613 00 22	Engine guard	
5027613 00 01	Tank guard	
5027613 00 03	Tank guard	
5027613 00 22	Tank guard	
5097613 00 01	Tank guard Solid	
5097613 00 03	Tank guard Solid	
5097613 00 22	Tank guard Solid	
731107	LED auxiliary headlights Nova	133
640100 00 01	Crash bar bag set V1	120
8107613 00 12	Skid plate	
8107613 00 01	Skid plate	
42127613 00 01	Handle guard	
5067613 00 01	Tankring Lock-it	900
5167613 00 01	Tankring Basic	700
42117613 00 91	Side stand enlargement	140
7007613 00 01	Headlight grilles	112

Item-no.	Description	Info's
<b>Tiger 900 / Rally / Rally Pro / GT / GT Pro / GT Low (2020-)</b>		
6537605 00 01	Side carrier	
6557605 01 01	Alurack f. Original rack	
6627605 01 01	Easyrack f. Original rack	
8007605 00 01	Rear rack enlargement	
6307605 00 01	C-Bow holder	
5017605 00 01	Engine guard	
5017605 00 03	Engine guard	
5017605 00 22	Engine guard	
5027605 00 01	Tank guard	
5027605 00 03	Tank guard	
5027605 00 22	Tank guard	
5097605 00 01	Tank guard Solid	
5097605 00 03	Tank guard Solid	
5097605 00 22	Tank guard Solid	
731107	LED auxiliary headlights Nova	133
640100 00 01	Crash bar bag set V1	
8107605 00 12	Skid plate	
8107605 00 01	Skid plate	
5057605 00 01	Center stand	177
42127605 00 01	Handle guard	
5067605 00 01	Tankring Lock-it	900
5167605 00 01	Tankring Basic	700
42117605 00 91	Side stand enlargement	140, 246, 261
42117610 00 91	Side stand enlargement	259
42117644 00 91	Side stand enlargement	260
7007605 00 01	Headlight grilles	112
<b>Bonneville / T 100 / SE (2002-)</b>		
650774 00 02	Complete carrier	
650790 00 02	Side carrier	22
650774 01 02	Rear rack	22, 3, B3
630790 00 02	C-Bow holder	
501708 00 02	Engine guard	
700790 00 01	Headlight grilles	122

Item-no.	Description	Info's
<b>Bonneville T 100 / Black (2017-)</b>		
6537559 00 01	Side carrier	90
6537559 00 02	Side carrier	90
6547559 01 01	Rear rack	3: B3
6547559 01 02	Rear rack	3: B3
6587559 01 01	Rear rack tube type	121, 141, 160
6307559 00 01	C-Bow holder	
6307559 00 02	C-Bow holder	
7007559 00 01	Headlight grilles	112
5017559 00 01	Engine guard	
5017559 00 02	Engine guard	
<b>Bonneville Amerika / Speedmaster (2005-2010)</b>		
6507507 00 02	Side carrier (Speedmaster)	
650782 00 02	Side carrier (Amerika)	
6507507 01 02	Rear rack (Speedmaster)	
650782 01 02	Rear rack (Amerika)	
6307507 00 02	C-Bow leather bag holder	
625782 00 02	Leather bag holder tube type	
611782 00 02	Sissybar with Rack	59
600782 00 02	Sissybar without Rack	59
<b>Bonneville Amerika / Speedmaster (2011-2017)</b>		
6507537 00 02	Side carrier (Speedmaster)	
6507507 00 02	Side carrier (Amerika)	
6507537 01 02	Rear rack	
6307507 00 02	C-Bow leather bag holder	
5017507 00 02	Engine guard	
6117507 00 02	Sissybar with Rack	59
6007507 00 02	Sissybar without Rack	59
4007507 00 02	Twinlight Set	

## NOTICE Tank rings TRIUMPH

Our tank ring Lock-it 506001-6 / Basic 516001-6 fits all TRIUMPH models with 6 hole mounting.

506001-6	Tank ring Lock-it 6-hole
516001-6	Tank ring Basic 6-hole



**ATTENTION: You can find the new 2024 models online at [www.hepco-becker.de](http://www.hepco-becker.de)**



Info reference see p. 271

The last digit of the item-no. refers to the colours: 01= black 02= chrome 03= white 04= red 05= anthracite 06= orange 08= yellow 09= silver 10= blue metallic 12= Alu brushed 22= Stainless steel 91= silver/black

Item-no.	Description	Info's	Item-no.	Description	Info's	Item-no.	Description	Info's	Item-no.	Description	Info's
<b>Bonneville Speedmaster (2018-)</b>			<b>Tiger (1993-1998)</b>			<b>Trophy 900 (1993-1995)</b>			<b>Speed Triple 1050 (2008-2010)</b>		
5017572 00 01	Engine guard		650733 00 01	Side carrier	8	650736 01 01	Rear rack	22	650755 01 01	Alurack	
5017572 00 02	Engine guard		650733 01 01	Rear rack	8	<b>Sprint ST / RS (1999-2004)</b>			661755 01 01	Easyrack	
6307572 00 02	C-Bow holder		501700 00 01	Engine guard		650760 00 01	Side carrier	57	630775 00 01	C-Bow holder	
6307572 00 01	C-Bow holder		<b>Tiger (1999-2000)</b>			650760 01 01	Rear rack	57	506755 00 01	Tankring Lock-it	900
6537572 00 01	Side carrier		650759 00 01	Side carrier	0	506760 00 01	Tankring Lock-it	900	516755 00 01	Tankring Basic	700
6537572 00 02	Side carrier		650759 01 01	Rear rack	9	<b>Speed Triple T 509 (1999-2001)</b>			<b>Speed Triple 1050 (2011-2015)</b>		
6547572 01 01	Rear rack		501703 00 01	Engine guard		650756 01 01	Rear rack		6507506 01 01	Minirack	106,115
6547572 01 02	Rear rack		<b>Daytona 900 (1993-1996)</b>			<b>Speed Triple T 509 (2002-2004)</b>			6307506 00 01	C-Bow holder	212
4007572 00 01	Twinlight		650745 01 01	Rear rack		650783 01 01	Rear rack		6707506 00 01	Lock-it Sportrack	52,169
<b>Thraxton (2004-2015)</b>			506745 00 01	Tankring Lock-it	900	<b>Daytona T 595 (1999-2001)</b>			5067506 00 01	Tankring Lock-it	900
650789 00 02	Side carrier		516745 00 01	Tankring Basic	700	650756 01 01	Rear rack		5167506 00 01	Tankring Basic	700
650789 01 02	Rear rack	77	<b>Legend TT (1999-2001)</b>			<b>Sprint RS (2000-2004)</b>			<b>Speed Triple 1050 (2016-2020)</b>		
630789 00 01	C-Bow holder	77	650764 00 02	Complete carrier		650765 00 01	Side carrier	58	6307548 00 01	C-Bow holder	
501710 00 02	Engine guard		650764 01 02	Rear rack	22	650765 01 01	Rear rack	58	6707548 00 01	Sportrack	52
<b>Street Twin (2016-2021)</b>			501701 00 02	Engine guard		<b>Daytona 955 i (1999-2001)</b>			5067548 00 01	Tankring Lock-it	900
6537543 00 01	Side carrier		<b>Thunderbird (1995-1998)</b>			650756 01 01	Rear rack		5167548 00 01	Tankring Basic	700
6537543 00 02	Side carrier		650742 00 02	Complete carrier		<b>Daytona 955 i (2002-2006)</b>			<b>Sprint ST 1050 (2005-2010)</b>		
6547543 01 01	Rear rack	3: B3	650742 01 02	Rear rack	27,68	506756 00 01	Tankring Lock-it	900	650792 00 01	Side carrier	
6547543 01 02	Rear rack	3: B3	501701 00 02	Engine guard		516756 00 01	Tankring Basic	700	650792 01 01	Rear rack	
6307543 00 01	C-Bow holder		<b>Thunderbird (1999-2003)</b>			<b>Daytona 955 i (2002-2006)</b>			506792 00 01	Tankring Lock-it	900
6307543 00 02	C-Bow holder		650764 00 02	Complete carrier		650783 01 01	Rear rack		516792 00 01	Tankring Basic	700
5017543 00 01	Engine guard		650764 01 02	Rear rack	22	<b>Thunderbird 955i (2001-2006)</b>			<b>Tiger 1050 (2007-2013)</b>		
5017543 00 02	Engine guard		501701 00 02	Engine guard		650773 00 01	Side carrier	0,24	650704 00 01	Side carrier Lock-it	
7007543 00 01	Headlight grilles	112	<b>Thunderbird Sport (1998-1999)</b>			650773 01 01	Rear rack		650704 01 01	Alurack	
<b>Scrambler 900 (2006-)</b>			650761 01 02	Rear rack		501707 00 01	Engine guard		650715 01 01	Alurack	47
650789 01 02	Rear rack		<b>Thunderbird Sport (2000-2003)</b>			506773 00 01	Tankring Lock-it	900	661704 01 01	Easyrack	
501708 00 02	Engine guard		650768 01 02	Rear rack		516773 00 01	Tankring Basic	700	661715 01 01	Easyrack	47
<b>Speed Triple 900 (1994-1996)</b>			<b>Trident 900 (1992-1998) / Sprint (1993-1994)</b>			<b>Speed Triple 1050 (2006-2007)</b>			<b>TRIUMPH</b>		
650745 01 01	Rear rack		650735 00 01	Complete carrier		650775 01 01	Rear rack		Our tank ring Lock-it 506001-6 / Basic 516001-6 fits all TRIUMPH models with 6 hole mounting.		
<b>Street Scrambler (2017-)</b>			650735 01 01	Rear rack	22	506775 00 01	Tankring Lock-it	900	506001-6	Tank ring Lock-it 6-hole	
6547557 01 01	Rear rack tube type		<b>Sprint (1995-1998)</b>			516775 00 01	Tankring Basic	700	516001-6	Tank ring Basic 6-hole	
6137557 00 01	Solorack without Backrest		650744 00 01	Complete carrier		<b>NOTICE Tank rings TRIUMPH</b>					
5017557 00 01	Engine guard		650744 01 01	Rear rack	22	Our tank ring Lock-it 506001-6 / Basic 516001-6 fits all TRIUMPH models with 6 hole mounting.					
7007557 00 01	Headlight grilles	112									
6317557 00 01L	C-Bow, one-sided left										



**ATTENTION: You can find the new 2024 models online at [www.hepco-becker.de](http://www.hepco-becker.de)**





Item-no.	Description	Info's
<b>Tiger 1050 Sport (2013-)</b>		
6507523 01 01	Alurack	
6617523 01 01	Easyrack	
6307523 00 01	C-Bow holder	
5017523 00 01	Engine guard incl. Protectionpad	
8007523 00 01	Rear rack enlargement	
5067523 00 01	Tankring Lock-it	900
5167523 00 01	Tankring Basic	700
<b>1200 Thruxton / R / RS (2016-)</b>		
6547542 01 01	Rear rack	141
6547542 01 02	Rear rack	141
6307542 00 02	C-Bow holder	
6307542 00 01	C-Bow holder	
5017542 00 01	Engine guard	
5017542 00 02	Engine guard	
7007542 00 01	Headlight grilles	112
42197542 00 01	Reling / Pillion handle	96
42197542 00 02	Reling / Pillion handle	96
<b>Speed Triple 1200 RS (2021-)</b>		
5067624 00 01	Tank ring Lock-it	902
5167624 00 01	Tank ring Basic	702
6307624 00 01	C-Bow holder	209
6707624 00 01	Sportrack	52,169
<b>Bonneville T 120 / Black (2016-)</b>		
6537544 00 01	Side carrier	
6537544 00 02	Side carrier	
6547544 01 01	Rear rack	3: B3
6547544 01 02	Rear rack	3: B3
6587544 01 01	Rear rack tube type	100, 141,160
6307544 00 01	C-Bow holder	
6307544 00 02	C-Bow holder	
5017544 00 01	Engine guard	
5017544 00 02	Engine guard	
7007544 00 01	Headlight grilles	112

Item-no.	Description	Info's
<b>Bonneville Bobber (2017-)</b>		
6307558 00 01	C-Bow holder	
6547558 01 01	Rear rack tube type	141
5017558 00 01	Engine guard	
5017558 00 02	Engine guard	
<b>Scrambler 1200 XC (2019-)</b>		
6317587 00 01L	C-Bow holder, one-sided	
6537587 00 01	Side carrier, one-sided	36
6587587 01 01	Rear rack tube type	141
7007587 00 01	Headlight grilles	112
5057587 00 01	Center stand	
5017587 00 01	Engine guard	
<b>Scrambler 1200 XE (2019-)</b>		
6317588 00 01L	C-Bow holder, one-sided	
6537588 00 01	Side carrier, one-sided	36
6587588 01 01	Rear rack tube type	141
7007588 00 01	Headlight grilles	112
5057588 00 01	Center stand	
5017588 00 01	Engine guard	
<b>Speed Twin (2019-)</b>		
6307591 00 01	C-Bow holder	
6527591 01 01	Alurack	
6617591 01 01	Easyrack	
6587591 01 01	Rear rack tube type	141
7007591 00 01	Headlight grilles	112
5017591 00 01	Engine guard (-2021)	
5017591 00 02	Engine guard (-2021)	
5017647 00 01	Engine guard (2022-)	
5017647 00 02	Engine guard (2022-)	

Item-no.	Description	Info's
<b>Tiger Explorer 1200 XR/X, XC/X (2012-2015)</b>		
6507513 00 01	Side carrier Lock-it	
6507513 01 01	Alurack	9
6617513 01 01	Easyrack	9
6307513 00 01	C-Bow holder	
5017513 00 01	Engine guard	
5057513 00 01	Center stand	
7007513 00 01	Headlight grilles	112,163
4207513-01	Center stand guard	
4207513-11	Handle guard	
5067513 00 01	Tankring Lock-it	900
5167513 00 01	Tankring Basic	700
731107	LED auxiliary headlights Nova	133
42117513 00 91	Side stand enlargement	
<b>Tiger Explorer 1200 / Tiger 1200 / XR/X, XC/X (2016-2021)</b>		
6507547 00 01	Side carrier Lock-it	
6557547 01 01	Alurack	9
6627547 01 01	Easyrack	9
6307547 00 01	C-Bow holder	
5057547 00 01	Center stand	
7007547 00 01	Headlight grilles (2016- 2017)	112,163
7017547 00 01	Headlight grilles (2018-)	112,166
42177547 00 12	Center stand guard	
42127547 00 01	Handle guard	
5067547 00 01	Tankring Lock-it	900
5167547 00 01	Tankring Basic	700
42117547 00 91	Side stand enlargement	
<b>Trophy 1200 (1993-1995)</b>		
650736 00 01	Complete carrier	
650736 01 01	Rear rack	22

Item-no.	Description	Info's
<b>Tiger 1200 Rally Explorer / GT Explorer (2022-)</b>		
6537639 00 01	Side carrier	0
6307639 00 01	C-Bow holder	
6557639 01 01	Alurack f. original rack	
6627639 01 01	Easyrack f. original rack	
8007639 00 01	Rear rack enlargement	
5067639 00 01	Tank ring Lock-it	902
5167639 00 01	Tank ring Basic	702
42127639 00 01	Handle guard	
7007639 00 01	Headlight grille	112
42117639 00 91	Side stand enlargement	
<b>Tiger 1200 Rally Pro / GT Pro / Tiger GT (2022-)</b>		
6537640 00 01	Side carrier	0
6307640 00 01	C-Bow holder	
6557640 01 01	Alurack f. original rack	
6627640 01 01	Easyrack f. original rack	
8007640 00 01	Rear rack enlargement	
5067640 00 01	Tank ring Lock-it	902
5167640 00 01	Tank ring Basic	702
42127640 00 01	Handle guard	
7007640 00 01	Headlight grille	112
5027640 00 01	Tank guard	120,247
5017640 00 01	Engine guard	205,248
42117640 00 91	Side stand enlargement	



**ATTENTION: You can find the new 2024 models online at [www.hepco-becker.de](http://www.hepco-becker.de)**



Info reference see p. 271

The last digit of the item-no. refers to the colours: 01= black 02= chrome 03= white 04= red 05= anthracite 06= orange 08= yellow 09= silver 10= blue metallic 12= Alu brushed 22= Stainless steel 91= silver/black

### NOTICE Tank rings TRIUMPH

Our tank ring Lock-it 506001-6 / Basic 516001-6 fits all TRIUMPH models with 6 hole mounting.

506001-6	Tank ring Lock-it 6-hole
516001-6	Tank ring Basic 6-hole

Item-no.	Description	Info's
<b>Thunderbird 1600 (2009-)</b>		
650720 00 01	Side carrier	154
650720 00 02	Side carrier	154
650720 01 01	Rear rack	154
650720 01 02	Rear rack	154
630720 00 01	C-Bow leather bag holder	102
630720 00 02	C-Bow leather bag holder	102
501720 00 01	Engine guard	
501720 00 02	Engine guard	
611720 00 01	Sissybar with Rack	59
611720 00 02	Sissybar with Rack	59
600720 00 01	Sissybar without Rack	59
600720 00 02	Sissybar without Rack	59
400720 00 02	Twinlight Set	

Item-no.	Description	Info's
<b>Thunderbird 1700 / LT / Commander / Storm (2011-)</b>		
650720 00 01	Side carrier	249
650720 00 02	Side carrier	249
650720 01 01	Rear rack	250
650720 01 02	Rear rack	250
630720 00 01	C-Bow leather bag holder	102,250
630720 00 02	C-Bow leather bag holder	102,250
501720 00 01	Engine guard	249
501720 00 02	Engine guard	249
611720 00 01	Sissybar with Rack	59,250
611720 00 02	Sissybar with Rack	59,250
600720 00 01	Sissybar without Rack	59,250
600720 00 02	Sissybar without Rack	59,250
400720 00 02	Twinlight Set	251

### Rocket III (2004-2010)

650711 00 01	Side carrier	
650711 00 02	Side carrier	
630754 00 01	C-Bow leather bag holder	
630754 00 02	C-Bow leather bag holder	
625783 00 02	Leather bag holder tube type	
600754 00 02	Solorack without Pad	59
612754 00 02	Solorack with Pad	59

### Rocket III Roadster (2011-2019)

650754 00 01	Side carrier	
650754 00 02	Side carrier	
630754 00 01	C-Bow leather bag holder	
630754 00 02	C-Bow leather bag holder	
600754 00 02	Solorack without Pad	59
612754 00 02	Solorack with Pad	59
506754 00 01	Tankring Lock-it	900
516754 00 01	Tankring Basic	700

### Rocket 3 R / GT (2020-)

6307606 00 01	C-Bow holder	
6307606 00 02	C-Bow holder	

Item-no.	Description	Info's	Item-no.	Description	Info's
<b>NOTICE Tank rings TRIUMPH</b>					
Our tank ring Lock-it 506001-6 / Basic 516001-6 fits all TRIUMPH models with 6 hole mounting.					
506001-6	Tank ring Lock-it 6-hole				
516001-6	Tank ring Basic 6-hole				

**ATTENTION: You can find the new 2024 models online at [www.hepco-becker.de](http://www.hepco-becker.de)**



Item-no.	Description	Info's
<b>MT-125 ABS (2014-2019)</b>		
6704543 00 01	Sportrack	52
5034543 00 05	Front guard	
<b>MT-125 (2020-)</b>		
5034566 00 01	Front guard	
5014566 00 01	Engine guard	
5064566 00 01	Tank ring Lock-it	904
5164566 00 01	Tank ring Basic	704
<b>TRZ 125 X (1997-1999)</b>		
506009-7/8	Tank ring Lock-it	
516009-7/8	Tank ring Basic	
<b>DT 125 X (2005-2006)</b>		
6504511 01 01	Rear rack	
<b>Majesty YP 125 R (2001-2009)</b>		
6504500 01 01	Rear rack	
<b>Majesty YP 125 R (1998-2000)</b>		
650432 01 01	Rear rack	
<b>SR 125 (1996-2001)</b>		
650489 00 02	Complete carrier	
650489 01 02	Rear rack	22
501411 00 02	Engine guard	
<b>TDR 125 (1993-2000)</b>		
650490 01 01	Rear rack	
506490 00 01	Tank ring Lock-it	907
516490 00 01	Tank ring Basic	707
<b>WR 125 R / X (2009-)</b>		
650434 01 01	Rear rack	13
<b>XSR 125 (2021-)</b>		
6304575 00 01	C-Bow holder	
6604575 01 01	Minirack	
5014575 00 01	Engine guard	
5034575 00 01	Front guard	
5044575 00 01	Rear guard	
42234575 00 01	Rear guard additional bow	187
<b>XT 125 R/X (2005-)</b>		
6504512 01 01	Rear rack	

Item-no.	Description	Info's
<b>XV 125 Virago (1997-2002)</b>		
650461 00 02	Complete carrier	
650461 01 02	Rear rack	22
625461 00 02	Leather bag holder tube type	
611401 00 02	Sissybar with rack	59
600401 00 02	Sissybar without rack	59
501405 00 02	Engine guard	
<b>XVS 125 Drag Star (2000-2004)</b>		
650436 00 02	Side carrier	
650436 01 02	Rear rack	
625436 00 02	Leather bag holder tube type	
611436 00 02	Sissybar with rack	59
600436 00 02	Sissybar without rack	59
611413 00 02	Solorack with pad	59
600413 00 02	Solorack without pad	59
501436 00 02	Engine guard	
400436 00 02	Twinlight Set	
<b>XMAX 125 / 300 / Tech MAX (2023-)</b>		
6524574 01 01	Alurack	
6614574 01 01	Easyrack	
6604574 01 01	Minirack	
42234574 00 01	Crash bar	

### NOTE tank rings YAMAHA

Our tank ring Lock-it 506006-5 / Basic 516006-5 fits all Yamaha MODELS with 5 hole mounting.

506006-5 Tank ring Lock-it 5-hole

516006-5 Tank ring Basic 5-hole

Our tank ring Lock-it 506009-7/8 / Basic 516009-7/8 fits all Yamaha MODELS with 7 or 8 hole mounting.

506009-7/8 Tank ring Lock-it 7/8-hole

516009-7/8 Tank ring Basic 7/8-hole

Item-no.	Description	Info's
<b>XV 250 S Virago (1989-2000)</b>		
650461 00 02	Complete carrier	
650461 01 02	Rear rack	27
625461 00 02	Leather bag holder tube type	
611401 00 02	Sissybar with rack	59
600401 00 02	Sissybar without rack	59
501405 00 02	Engine guard	
<b>XVS 250 Drag Star (2000-2004)</b>		
650436 00 02	Side carrier	
650436 01 02	Rear rack	
625436 00 02	Leather bag holder tube type	
611436 00 02	Sissybar with rack	59
600436 00 02	Sissybar without rack	59
611413 00 02	Solorack with pad	59
600413 00 02	Solorack without pad	59
501436 00 02	Engine guard	
400436 00 02	Twinlight Set	
<b>YP 250 Majesty (1995-1999)</b>		
650495 01 01	Rear rack	
<b>YP 250 Majesty (2000-)</b>		
650428 01 01	Rear rack	
<b>MT - 03 (2006-2014)</b>		
6504514 00 01	Side carrier	
6504514 01 01	Rear rack tube type	
5064514 00 01	Tank ring Lock-it	904
5164514 00 01	Tank ring Basic	704
501419 00 01	Engine guard	

Item-no.	Description	Info's
<b>MT - 03 (2016-2019)</b>		
6604552 01 01	Minirack	
6304552 00 01	C-Bow holder	
6704552 00 01	Sportrack	52
5014552 00 01	Engine guard	
5034552 00 01	Front guard	
5064552 00 01	Tank ring Lock-it	904
5164552 00 01	Tank ring Basic	704
<b>MT - 03 (2020-)</b>		
6304567 00 01	C-Bow holder	
6704567 00 01	Sportrack	52
5014567 00 01	Engine guard	
5064567 00 01	Tank ring Lock-it	904
5164567 00 01	Tank ring Basic	704
5034567 00 01	Front guard	
<b>Versity 300 (2003-)</b>		
6504508 01 01	Rear rack	
<b>YZF-R3 (2015-)</b>		
6304544 00 01	C-Bow holder	130
6704544 00 01	Sportrack	52
5064544 00 01	Tank ring Lock-it	904
5164544 00 01	Tank ring Basic	704
<b>XT 350 (1985-1995)</b>		
650443 00 01	Side carrier	0,5:A,B, C,D,E, F
<b>Majesty 400 / MBK Skyliner 400 (2004-)</b>		
6504509 01 01	Rear rack	
<b>SR 400 (2014-2016)</b>		
6504541 00 02	Complete carrier	8,5:A,B, C,D,E, F
6504541 01 02	Rear rack	
6304541 00 02	C-Bow holder	
5014541 00 02	Engine guard	
<b>XJ 400 F (1981-1985)</b>		
650404 00 02	Complete carrier	
650404 01 02	Rear rack	
<b>XS 400 DOHC Seca (1982-)</b>		
650403 00 01	Complete carrier	
650403 00 02	Complete carrier	

**ATTENTION: You can find the new 2024 models online at [www.hepco-becker.de](http://www.hepco-becker.de)**



Info reference see p. 271

The last digit of the item-no. refers to the colours: 01= black 02= chrome 03= white 04= red 05= anthracite 06= orange 08= yellow 09= silver 10= blue metallic 12= Alu brushed 22= Stainless steel 91= silver/black

Item-no.	Description	Info's
<b>XT 400</b>		
650408 00 01	Complete carrier	0
<b>X-MAX 400 / ABS (2013-2017)</b>		
6504542 01 01	Alurack	
6614542 01 01	Easyrack	
<b>TMAX 500 (2005-2007)</b>		
650441 01 01	Rear rack	
<b>TMAX 500 (2008-2011)</b>		
6504528 01 01	Alurack	
6614528 01 01	Easyrack	
<b>XT 500 (1975-1985)</b>		
650425 00 01	Complete carrier	0
650425 01 01	Rear rack	22
<b>XT 500 (1986-1989)</b>		
650450 00 01	Complete carrier	0
650450 01 01	Rear rack	22
<b>XV 500 SE (1983-1987)</b>		
650437 00 02	Complete carrier	
<b>TMAX 530 ABS (2012-2017)</b>		
6504534 01 01	Alurack	
6614534 01 01	Easyrack	
<b>TMAX 530 / SX / DX (2018-2021)</b>		
6524561 01 01	Alurack	
6614561 01 01	Easyrack	
6604561 01 01	Minirack	
<b>TMAX 560 Tech MAX (2022-)</b>		
6524576 01 01	Alurack	
6614576 01 01	Easyrack	
6604576 01 01	Minirack	
<b>SR 500 (1978-1998)</b>		
650405 00 02	Complete carrier	8, 4: A
650405 01 02	Rear rack	

Item-no.	Description	Info's
<b>XV 535 / S Virago (1988-1998)</b>		
650457 00 02	Complete carrier	
650457 01 02	Rear rack	22
625457 00 02	Leather bag holder tube type	3:P,S
611402 00 02	Sissybar with rack	59
600402 00 02	Sissybar without rack	59
501401 00 02	Engine guard	
400457 00 02	Twinlight Set	
<b>XV 535 / S Virago (1999-2003)</b>		
650457 00 02	Complete carrier	
650457 01 02	Rear rack	22
625458 00 02	Leather bag holder tube type	
611402 00 02	Sissybar with rack	59
600402 00 02	Sissybar without rack	59
501401 00 02	Engine guard	
400457 00 02	Twinlight Set	
<b>XJ 550 F (1981-1985)</b>		
650404 00 02	Complete carrier	
650404 01 02	Rear rack	
<b>XT 550 Bj. 1982-1983)</b>		
650408 00 01	Complete carrier	0
<b>XZ 550 / S (1982-1984)</b>		
650407 00 02	Complete carrier	
<b>TMAX 560 / TechMAX (2020-2021)</b>		
6524569 01 01	Alurack	
6614569 01 01	Easyrack	
6604569 01 01	Minirack	

Item-no.	Description	Info's
<b>FZ 6 / Fazer (2004-2006)</b>		
6504506 00 01	Side carrier	
6504506 00 09	Side carrier	
6504506 01 01	Alurack	
6504506 01 09	Alurack	
6614506 01 01	Easyrack	
6614506 01 09	Easyrack	117
501417 00 01	Engine guard	
5054506 00 01	Center stand	
42154506 00 01	Pillion footrest lowering kit	
42154506 00 09	Pillion footrest lowering kit	
5064506 00 01	Tank ring Lock-it	904
5164506 00 01	Tank ring Basic	704
<b>FZ 6 / Fazer (2007-2009)</b>		
6504521 00 01	Side carrier Lock-it	
6504521 00 09	Side carrier Lock-it	
6504521 01 01	Alurack	
6504521 01 09	Alurack	
6614521 01 01	Easyrack	
6614521 01 09	Easyrack	117
501417 00 01	Engine guard	
5064521 00 01	Tank ring Lock-it	904
5164521 00 01	Tank ring Basic	704
<b>FZ 6 Fazer S2 (2007-2010)</b>		
6504520 00 01	Side carrier Lock-it	
6504520 00 09	Side carrier Lock-it	
6504520 01 01	Alurack	
6504520 01 09	Alurack	
6614520 01 01	Easyrack	
6614520 01 09	Easyrack	117
6304520 00 01	C-Bow holder	
501417 00 01	Engine guard	
5064520 00 01	Tank ring Lock-it	904
5164520 00 01	Tank ring Basic	704

Item-no.	Description	Info's
<b>FZR 600 (1988-1990)</b>		
650460 00 01	Complete carrier	5:A,B,C,D,E,F
650460 01 01	Rear rack	
506460 00 01	Tank ring Lock-it	907
516460 00 01	Tank ring Basic	707
<b>FZR 600 (1991-1993)</b>		
650468 00 01	Complete carrier	5:A,B,C,D,E,F
650468 01 01	Rear rack	
506468 00 01	Tank ring Lock-it	907
516468 00 01	Tank ring Basic	707
<b>FZR 600 (1994-1996)</b>		
650478 00 01	Complete carrier	
650478 01 01	Rear rack	
506478 00 01	Tank ring Lock-it	907
516478 00 01	Tank ring Basic	707
<b>FZS 600 / S Fazer (1998-1999)</b>		
650496 00 01	Side carrier	
650496 01 01	Rear rack	
501413 00 01	Engine guard	
506496 00 01	Tank ring Lock-it	904
516496 00 01	Tank ring Basic	704

<b>NOTE tank rings YAMAHA</b>		
Our tank ring Lock-it 506006-5 / Basic 516006-5 fits all Yamaha MODELS with 5 hole mounting.		
506006-5	Tank ring Lock-it 5-hole	
516006-5	Tank ring Basic 5-hole	
Our tank ring Lock-it 506009-7/8 / Basic 516009-7/8 fits all Yamaha MODELS with 7 or 8 hole mounting.		
506009-7/8	Tank ring Lock-it 7/8-hole	
516009-7/8	Tank ring Basic 7/8-hole	

**ATTENTION: You can find the new 2024 models online at [www.hepco-becker.de](http://www.hepco-becker.de)**



Item-no.	Description	Info's	Item-no.	Description	Info's	Item-no.	Description	Info's	Item-no.	Description	Info's
<b>FZS 600 / S Fazer (2000-2004)</b>			<b>XJ 6 / Diversion (2013-2016)</b>			<b>XT 600 Z Ténéré (1986-1987)</b>			<b>XJ 650 (1980-1981)</b>		
650406 00 01	Side carrier		6504549 00 01	Side carrier Lock-it		650445 00 01	Side carrier	0	650411 00 02	Complete carrier	
650406 01 01	Rear rack		6504530 01 01	Alurack		650445 01 01	Rear rack	9	<b>XJ 650 (1982-1985)</b>		
630406 00 01	C-Bow holder		6614530 01 01	Easyrack		<b>XT 600 (small tank) (1987-1989)</b>			650435 00 02	Complete carrier	
501413 00 01	Engine guard		6304530 00 01	C-Bow holder		650454 00 01	Side carrier	0,45, 5:A,B, C,D,E, F	<b>XS 650 (1975-1983)</b>		
5054506 00 01	Center stand		5014530 00 01	Engine guard	252	650454 01 01	Rear rack	9	650409 00 02	Complete carrier	
506496 00 01	Tank ring Lock-it	904	5034530 00 01	Front guard	252	<b>XT 600Z Ténéré (1988-1990)</b>			650409 01 02	Rear rack	
516496 00 01	Tank ring Basic	704	5044530 00 01	Rear guard		650456 00 01	Side carrier	0	<b>XS 650 SE (1979-1983)</b>		
<b>SRX 600 (1986-1990)</b>			700007124	Pillion handle (from 6304530)	96	650456 01 01	Rear rack	9	650410 00 02	Complete carrier	
650446 00 02	Complete carrier		5064549 00 01	Tank ring Lock-it	904	<b>XT 600 E 90-94/600 K (1990-1994)</b>			<b>XVS 650 Drag Star (1996-2003)</b>		
650446 01 02	Rear rack	22	5164549 00 01	Tank ring Basic	704	650467 00 01	Complete carrier	0	650493 00 02	Side carrier	
506446 00 01	Tank ring Lock-it	907	<b>XJ 600 (1984-1985)</b>			650467 01 01	Rear rack		650493 01 02	Rear rack	
516446 00 01	Tank ring Basic	707	650440 00 01	Complete carrier	5:A,B, C,D,E, F	501403 00 01	Engine guard		625493 00 02	Leather bag holder tube type	3:P,S
<b>SZR 660 (1996-2000)</b>			650440 01 01	Rear rack	22	<b>XT 600 E (1995-2003)</b>			611404 00 02	Sissybar with rack	59
506483 00 01	Tank ring Lock-it	907	<b>XJ 600 (1986-1991)</b>			650480 00 01	Complete carrier	0	600404 00 02	Sissybar without rack	59
516483 00 01	Tank ring Basic	707	650449 00 01	Complete carrier	5:A,B, C,D,E, F	650480 01 01	Rear rack		611405 00 02	Solorack with pad	59
<b>TT 600 E/S (1993-1997)</b>			650449 01 01	Rear rack	22	<b>YZF 600 Thunder Cat (1996-2002)</b>			600405 00 02	Solorack without pad	59
650479 00 01	Complete carrier	0	<b>XJ 600 S/N Diversion (1991-1995)</b>			501407 00 01	Engine guard		501412 00 02	Engine guard	
<b>TT 600 R / RE (1998-2005)</b>			650473 00 01	Side carrier		<b>YZF 600 Thunder Cat (1996-2002)</b>			400493 00 02	Twinlight Set	
650423 00 01	Side carrier	0	650473 01 01	Rear rack		650486 01 01	Rear rack		<b>NOTE tank rings YAMAHA</b>		
650423 01 01	Rear rack		506473 00 01	Tankring Lock-it	907	506486 00 01	Tank ring Lock-it	907	Our tank ring Lock-it 506006-5 / Basic 516006-5 fits all Yamaha MODELS with 5 hole mounting.		
<b>XJ 6 / Diversion (2009-2012)</b>			516473 00 01	Tankring Basic	707	516486 00 01	Tank ring Basic	707	506006-5	Tank ring Lock-it 5-hole	
6504530 00 01	Side carrier Lock-it		501402 00 02	Engine guard		<b>YZF-R6 (1999-2002)</b>			516006-5	Tank ring Basic 5-hole	
6504530 01 01	Alurack		<b>XJ 600 S/N Diversion (1996-2003)</b>			650438 01 01	Rear rack		Our tank ring Lock-it 506009-7/8 / Basic 516009-7/8 fits all Yamaha MODELS with 7 or 8 hole mounting.		
6614530 01 01	Easyrack		650488 00 01	Side carrier		506438 00 01	Tank ring Lock-it	904	506009-7/8	Tank ring Lock-it 7/8-hole	
6304530 00 01	C-Bow holder		650488 01 01	Rear rack		516438 00 01	Tank ring Basic	704	516009-7/8	Tank ring Basic 7/8-hole	
5014530 00 01	Engine guard	252	506488 00 01	Tankring Lock-it	907	<b>YZF-R 6 (2009-2016)</b>			<b>NOTE tank rings YAMAHA</b>		
5034530 00 01	Front guard	252	516488 00 01	Tankring Basic	707	670402 00 01	Sportrack	52	Our tank ring Lock-it 506006-5 / Basic 516006-5 fits all Yamaha MODELS with 5 hole mounting.		
5044530 00 01	Rear guard		501402 00 02	Engine guard		506402 00 01	Tank ring Lock-it	904	506006-5	Tank ring Basic 5-hole	
700007124	Pillion handle (from 6304530)	96	<b>XT 600 (1984-1986)</b>			516402 00 01	Tank ring Basic	704	Our tank ring Lock-it 506009-7/8 / Basic 516009-7/8 fits all Yamaha MODELS with 7 or 8 hole mounting.		
5064530 00 01	Tank ring Lock-it	904	650426 00 01	Side carrier	0	<b>YZF-R 6 (2017-)</b>			506009-7/8	Tank ring Lock-it 7/8-hole	
5164530 00 01	Tank ring Basic	704	650426 01 01	Rear rack	9	6704555 00 01	Sportrack	52,169	516009-7/8	Tank ring Basic 7/8-hole	
42114530 00 91	Side stand enlargement		<b>XT 600 Z Ténéré (1984-1985)</b>			5064555 00 01	Tank ring Lock-it	904	<b>NOTE tank rings YAMAHA</b>		
			650427 00 01	Side carrier	0	5164555 00 01	Tank ring Basic	704	Our tank ring Lock-it 506006-5 / Basic 516006-5 fits all Yamaha MODELS with 5 hole mounting.		



**ATTENTION: You can find the new 2024 models online at [www.hepco-becker.de](http://www.hepco-becker.de)**



Info reference see p. 271

The last digit of the item-no. refers to the colours: 01= black 02= chrome 03= white 04= red 05= anthracite 06= orange 08= yellow 09= silver 10= blue metallic 12= Alu brushed 22= Stainless steel 91= silver/black

Item-no.	Description	Info's
<b>XVS 650 Drag Star Classic (1998-2007)</b>		
650497 00 02	Side carrier	
650497 01 02	Rear rack	
625497 00 02	Leather bag holder tube type	
410497 00 02	Fender Guard	
611406 00 02	Sissybar with rack	59
600406 00 02	Sissybar without rack	59
611407 00 02	Solorack with pad	59
600407 00 02	Solorack without pad	59
501412 00 02	Engine guard	
400497 00 02	Twinlight Set	
<b>SZR 660 (1996-2000)</b>		
650483 01 01	Rear rack	
<b>XT 660 R/X (2004-2006)</b>		
6504523 00 01	Side carrier Lock-it	
6504523 01 01	Rear rack	
502404 00 01	Engine guard	76
5054505 00 01	Center stand	
<b>XT 660 R/X (2007-2016)</b>		
6504525 00 01	Side carrier Lock-it	
6504525 01 01	Rear rack	
502404 00 01	Engine guard	76
5054505 00 01	Center stand	

Item-no.	Description	Info's
<b>NOTE tank rings YAMAHA</b>		
Our tank ring Lock-it 506006-5 / Basic 516006-5 fits all Yamaha MODELS with 5 hole mounting.		
506006-5	Tank ring Lock-it 5-hole	
516006-5	Tank ring Basic 5-hole	
Our tank ring Lock-it 506009-7/8 / Basic 516009-7/8 fits all Yamaha MODELS with 7 or 8 hole mounting.		
506009-7/8	Tank ring Lock-it 7/8-hole	
516009-7/8	Tank ring Basic 7/8-hole	

Item-no.	Description	Info's
<b>XTZ 660 Ténéré (1991-1993)</b>		
650469 00 01	Side carrier	0
650469 01 01	Rear rack	9
502401 00 01	Engine guard	
<b>XTZ 660 Ténéré (1994-1999)</b>		
650469 00 01	Side carrier	0
650469 01 01	Rear rack	9
502403 00 01	Engine guard	
<b>XT 660 Z Ténéré (2008-2016)</b>		
6504526 00 01	Side carrier Lock-it	
6504535 00 01	Side carrier	95
6504526 01 01	Alurack	9
6614526 01 01	Easyrack	9
502405 00 01	Engine guard	
5054526 00 01	Center stand	
7004526 00 01	Headlight grille	112
731107	LED auxiliary headlights Nova	133
8004526 00 01	Rear rack enlargement	
5064526 00 01	Tank ring Lock-it (2011-)	904
5164526 00 01	Tank ring Basic (2011-)	704
<b>XT 660 Ténéré ABS (2008-2016)</b>		
6504526 00 01	Side carrier Lock-it	
6504535 00 01	Side carrier	95
6504526 01 01	Alurack	9
6614526 01 01	Easyrack	9
502405 00 01	Engine guard	
5054507 00 01	Center stand	
7004526 00 01	Headlight grille	112
8004526 00 01	Rear rack enlargement	
5064535 00 01	Tank ring Lock-it (2011-)	904
5164535 00 01	Tank ring Basic (2011-)	704

Item-no.	Description	Info's
<b>XSR 700 / Xtribute (2016-2021)</b>		
6504550 00 05	Side carrier Lock-it	
6524550 01 05	Alurack	
6614550 01 05	Easyrack	
6604550 01 05	Minirack	
6304550 00 01	C-Bow holder	134
5014550 00 05	Engine guard incl. Protectionpad (2016-2021)	
7004550 00 01	Headlight grille	112
42144550 00 01	Speedometer rising kit	253
5064550 00 01	Tank ring Lock-it	84; 2:L1,L2, M1
5164550 00 01	Tank ring Basic	84; 2:L1,L2, M1
42114550 00 91	Side stand enlargement	
<b>XSR 700 / Xtribute (2022-)</b>		
6504578 00 05	Side carrier Lock-it	
6304578 00 01	C-Bow holder	
6524578 01 05	Alurack	
6614578 01 05	Easyrack	
6604578 01 05	Minirack	
5064578 00 01	Tank ring Lock-it	84; 2:L1,L2, M1
5164578 00 01	Tank ring Basic	84; 2:L1,L2, M1
5014578 00 01	Engine guard	
7004578 00 01	Headlight grille	112
42114578 00 91	Side stand enlargement	

Item-no.	Description	Info's
<b>MT - 07 (2014-2017)</b>		
6504537 00 05	Side carrier Lock-it	
6504537 01 05	Alurack	
6614537 01 05	Easyrack	118
6604537 01 05	Minirack	
6304537 00 05	C-Bow holder	
5014537 00 05	Engine guard incl. Protectionpad	
6704537 00 01	Sportrack	52
5034537 00 05	Front guard	
5044537 00 05	Lock-it Rear guard	
4204537-02	Speedometer rising kit	
5054537 00 01	Center stand	
42114537 00 91	Side stand enlargement	
5064537 00 01	Tank ring Lock-it incl. Speedometer rising kit	4; L1,L2,M1
5164537 00 01	Tank ring Basic incl. Speedometer rising kit	4; L1,L2,M1
<b>MT - 07 (2018-2020)</b>		
6504560 00 05	Side carrier Lock-it	
6524560 01 05	Alurack	
6614560 01 05	Easyrack	
6604560 01 05	Minirack	
6304560 00 05	C-Bow holder	
5014560 00 05	Engine guard incl. Protectionpad	161
6704560 00 01	Sportrack	52
5034560 00 05	Front guard	
5044560 00 05	Rear guard	
42144560 00 01	Speedometer rising kit	
5054560 00 01	Center stand	
5064560 00 01	Tank ring Lock-it incl. Speedometer rising kit	4; L1,L2, M1, M2
5164560 00 01	Tank ring Basic incl. Speedometer rising kit	4; L1,L2, M1, M2
42114560 00 91	Side stand enlargement	150

**ATTENTION: You can find the new 2024 models online at [www.hepco-becker.de](http://www.hepco-becker.de)**



Item-no.	Description	Info's	Item-no.	Description	Info's	Item-no.	Description	Info's	Item-no.	Description	Info's
<b>MT - 07 (2021-)</b>			<b>Ténéré 700 / Rally (2019-)</b>			<b>Ténéré 700 World Raid (2022-)</b>			<b>Tracer 700 / GT (2016-2020)</b>		
6504571 00 05	Side carrier Lock-it		6534564 00 01	Side carrier	0	6534579 00 01	Side carrier	0	6504554 00 01	Side carrier Lock-it	255
6524571 01 05	Alurack		6514564 00 22	Cutout carrier	4:C3,C4	6514579 00 22-00-40	Xplorer Cutout Set		6304554 00 01	C-Bow holder	255
6614571 01 05	Easyrack		6514564 00 22-00-40	Xplorer Cutout Set		6514579 00 22-01-40	Xplorer Cutout Set Black		6524554 01 01	Alurack	255
6604571 01 05	Minirack		6514564 00 22-01-40	Xplorer Cutout Set Black		6514579 00 22	Cutout carrier	4: C3, C4	6614554 01 01	Easyrack	255
6304571 00 05	C-Bow holder		6524564 01 01	Alurack		6304579 00 01	C-Bow holder	173	6604554 01 01	Minirack	255
5014571 00 05	Engine guard incl. Protectionpad		6614564 01 01	Easyrack		6524579 01 01	Alurack		5014554 00 01	Engine guard incl. Protectionpad (-2019)	
6704571 00 01	Sportrack	52	6604564 01 01	Minirack		6614579 01 01	Easyrack		5014568 00 01	Engine guard incl. Protectionpad (2020)	
5034571 00 05	Front guard	82	6304564 00 01	C-Bow holder	173	6604579 01 01	Minirack		5064554 00 01	Tank ring Lock-it	904, 4: L1, L2, M1
5044571 00 05	Rear guard		5014564 00 01	Engine guard	254	8004579 00 01	Rear rack enlargement		5164554 00 01	Tank ring Basic	704, 4: L1, L2, M1
5054571 00 01	Center stand		640100 00 01	Crash bar bag set V1		5064579 00 01	Tank ring Lock-it	3: L4, L6, M2	5054554 00 01	Center stand	
5064571 00 01	Tank ring Lock-it	4: L1, L2, M1, M2	5024564 00 01	Tank guard		5164579 00 01	Tank ring Basic	3: L4, L6, M2	42114554 00 91	Side stand enlargement	
5164571 00 01	Tank ring Basic	4: L1, L2, M1, M2	5024564 00 22	Tank guard		42124579 00 01	Handle guard		<b>Tracer 7 / GT (2021-)</b>		
42114571 00 91	Side stand enlargement	150	5024570 00 01	Tank guard Solid	61	5024579 00 01	Tank guard Solid		6504568 00 01	Side carrier Lock-it	255
<b>R7 (2021-)</b>			8104564 00 12	Skid plate (-2020)		8104579 00 01	Engine guard		6304568 00 01	C-Bow holder	255
5064574 00 01	Tank ring Lock-it	904	8104564 00 01	Skid plate (-2020)		7004579 00 01	Headlight grille	112	6524568 01 01	Alurack	255
5164574 00 01	Tank ring Basic	704	8104570 00 12	Skid plate (2021-)		731107	LED auxiliary headlights Nova	133	6614568 01 01	Easyrack	255
			8104570 00 01	Skid plate (2021-)		5054579 00 01	Center stand		6604568 01 01	Minirack	255
			5064564 00 01	Tank ring Lock-it		42114579 00 91	Side stand enlargement		5014568 00 01	Engine guard incl. Protectionpad	
			5164564 00 01	Tank ring Basic		640100 00 01	Crash bar bag set V1		5064568 00 01	Tank ring Lock-it	904, 4: L1, L2, M1
			5054564 00 01	Center stand		7414579 00 01	Tool box	138	5164568 00 01	Tank ring Basic	704, 4: L1, L2, M1
			7414564 00 01	Tool box	138				5054568 00 01	Center stand	
			731107	LED auxiliary headlights Nova	133				42114568 00 91	Side stand enlargement	
			7004564 00 01	Headlight grille	112				<b>FZ 750 (1984)</b>		
			42114564 00 91	Side stand enlargement					650444 00 01	Complete carrier	
			42124564 00 01	Handle guard					650444 01 01	Rear rack	22
			8004564 00 01	Rear rack enlargement					506444 00 01	Tank ring Lock-it (1984-1986)	907
									516444 00 01	Tank ring Basic (1984-1986)	707
									<b>FZ 750 Genesis (1985-1994)</b>		
									650451 00 01	Complete carrier	5:A,B, C,D,E, F
									650451 01 01	Rear rack	22
									506451 00 01	Tank ring Lock-it	907
									516451 00 01	Tank ring Basic	707

### NOTE tank rings YAMAHA

Our tank ring Lock-it 506006-5 / Basic 516006-5 fits all Yamaha MODELS with 5 hole mounting.

506006-5 Tank ring Lock-it 5-hole

516006-5 Tank ring Basic 5-hole

Our tank ring Lock-it 506009-7/8 / Basic 516009-7/8 fits all Yamaha MODELS with 7 or 8 hole mounting.

506009-7/8 Tank ring Lock-it 7/8-hole

516009-7/8 Tank ring Basic 7/8-hole



**ATTENTION: You can find the new 2024 models online at [www.hepco-becker.de](http://www.hepco-becker.de)**



Info reference see p. 271

The last digit of the item-no. refers to the colours: 01= black 02= chrome 03= white 04= red 05= anthracite 06= orange 08= yellow 09= silver 10= blue metallic 12= Alu brushed 22= Stainless steel 91= silver/black

Item-no.	Description	Info's	Item-no.	Description	Info's	Item-no.	Description	Info's	Item-no.	Description	Info's			
<b>FZR 750 (1987-1988)</b>			<b>XV 750 Virago (1992-1998)</b>			<b>XS 850 (1980-1982)</b>			<b>XSR 900 (2022-)</b>					
650453 00 01	Complete carrier	21, 5:A,B, C,D,E, F	650494 00 02	Complete carrier	154	650416 00 02	Complete carrier	5:A,B, C,D,E, F	6304562 00 01	C-Bow holder				
650453 01 01	Rear rack	22	650494 01 02	Rear rack	154	<b>TDM 850 (1991-1995)</b>			5064562 00 01	Tank ring Lock-it	904			
506453 00 01	Tank ring Lock-it	907	650464 00 02	Complete carrier	154	650472 00 01	Complete carrier		5164562 00 01	Tank ring Basic	704			
516453 00 01	Tank ring Basic	707	650464 01 02	Rear rack	22,154	650472 00 02	Complete carrier		6524562 01 01	Alurack				
<b>XJ 750 F (1984-1985)</b>			625464 00 02	Leather bag holder tube type	3:P,5	650472 01 01	Rear rack	22	6614562 01 01	Easyrack				
650417 00 01	Complete carrier		611403 00 02	Sissybar with rack	59	501410 00 01	Engine guard		6604562 01 01	Minirack				
650417 01 01	Rear rack		600403 00 02	Sissybar without rack	59	505485 00 01	Center stand		5014562 00 01	Engine guard incl. Protectionpad				
<b>XJ 750 Seca (1982-1984)</b>			501406 00 02	Engine guard		506472 00 01	Tank ring Lock-it	907	7004562 00 01	Headlight grille	112			
650415 00 02	Complete carrier	21	400464 00 02	Twinlight Set		516472 00 01	Tank ring Basic	707	42114562 00 91	Side stand enlargement				
<b>XS 750 (1976-1979)</b>			<b>YZF 750 (1993-1995)</b>			<b>TDM 850 (1996-2001)</b>			<b>XJ 900 S Diversion (1994-2003)</b>					
650412 00 02	Complete carrier	5:A,B, C,D,E, F	650477 00 01	Complete carrier	5:A,B, C,D,E, F	650485 00 01	Complete carrier		650481 00 01	Side carrier				
<b>XS 750 SE (1980-1981)</b>			650477 01 01	Rear rack		650485 01 01	Rear rack	22	650481 01 01	Rear rack				
650413 00 02	Complete carrier		506477 00 01	Tank ring Lock-it	907	501410 00 01	Engine guard		501408 00 02	Engine guard				
<b>XTZ 750 Super Ténéré (1989-1997)</b>			516477 00 01	Tank ring Basic	707	505485 00 01	Center stand		506481 00 01	Tank ring Lock-it	907			
650463 00 01	Side carrier	0	<b>FZX 750 Fazer (1985)</b>			506485 00 01	Tank ring Lock-it	907	516481 00 01	Tank ring Basic	707			
650474 00 01	Side carrier	46,0	650452 00 02	Complete carrier		516485 00 01	Tank ring Basic	707	<b>MT - 09 (2013-2016)</b>					
650463 01 01	Rear rack	9	<b>FZ 8 (2010-2016)</b>			<b>XSR 900 (2016-2021)</b>			6504539 00 05	Side carrier Lock-it	104			
502402 00 01	Engine guard		6504532 00 01	Side carrier Lock-it		6604551 01 01	Minirack	100	6504536 00 05	Side carrier Lock-it				
502402 00 03	Engine guard		6304532 00 01	C-Bow holder		6314551 00 01	C-Bow holder	27	6504536 01 05	Alurack				
<b>XV 750 SE (1981-1987)</b>			5014532 00 01	Engine guard		6304551 00 01	C-Bow holder		6614536 01 05	Easyrack	118			
650414 00 02	Complete carrier		5064532 00 01	Tank ring Lock-it	904	42184551 00 01	C-Bow Modification kit		6304536 00 05	C-Bow holder				
650414 01 02	Rear rack	22	5164532 00 01	Tank ring Basic	704	5014551 00 05	Engine guard incl. Protectionpad		6304535 00 05	C-Bow holder	96			
<b>XV 750 Virago (-1991)</b>			<b>FZ 8 Fazer (2010-2016)</b>			640100 00 01	Crash bar bag set V1		5014536 00 05	Engine guard incl. Protectionpad				
650447 00 02	Complete carrier		6504533 00 01	Side carrier Lock-it		8104551 00 91	Belly pan		640100 00 01	Crash bar bag set V1				
<b>NOTE tank rings YAMAHA</b> Our tank ring Lock-it 506006-5 / Basic 516006-5 fits all Yamaha MODELS with 5 hole mounting. 506006-5 Tank ring Lock-it 5-hole 516006-5 Tank ring Basic 5-hole Our tank ring Lock-it 506009-7/8 / Basic 516009-7/8 fits all Yamaha MODELS with 7 or 8 hole mounting. 506009-7/8 Tank ring Lock-it 7/8-hole 516009-7/8 Tank ring Basic 7/8-hole			6614533 01 01	Easyrack		5054551 00 01	Center stand		731107	LED auxiliary headlights Nova	133			
			6304533 00 01	C-Bow holder		42114551 00 91	Side stand enlargement		5054536 00 01	Center stand				
			5014533 00 01	Engine guard		7004551 00 01	Headlight grille	112	8104536 00 91	Belly pan				
			5064533 00 01	Tank ring Lock-it	904	5064551 00 01	Tank ring Lock-it		5064536 00 01	Tank ring Lock-it	904			
			5164533 00 01	Tank ring Basic	704	5164551 00 01	Tank ring Basic		5164536 00 01	Tank ring Basic	704			
			<b>TRX 850 (1996-1999)</b>			650484 01 01	Rear rack		42154551 00 05	Pillion footrest lowering kit	50	42114536 00 91	Side stand enlargement	
			650484 00 01	Tank ring Lock-it	907									
			516484 00 01	Tank ring Basic	707									

▶▶▶ **ATTENTION: You can find the new 2024 models online at [www.hepco-becker.de](http://www.hepco-becker.de)**



HEPCO & BECKER

YAMAHA



Item-no.	Description	Info's	Item-no.	Description	Info's	Item-no.	Description	Info's	Item-no.	Description	Info's
<b>MT - 09 (2017-2020)</b>			<b>Tracer 900 / GT (2018-2020)</b>			<b>Tracer 9 / GT (2021-)</b>			<b>XV 950 / R (2013-2020)</b>		
6504557 00 05	Side carrier Lock-it	75	6504559 00 05	Side carrier Lock-it		5014572 00 01	Engine guard		6504538 01 01	Rear rack	88,126
6524557 01 05	Alurack	75	6524559 01 05	Alurack		6524572 01 01	Alurack		6264538 00 01	Rugged Cutout	195 4:R2
6614557 01 05	Easyrack	75	6614559 01 05	Easyrack		6614572 01 01	Easyrack		6114538 00 01	Sissybar with rack	126
6604557 01 05	Minirack		6304559 00 05	C-Bow holder		8004572 00 01	Rear rack enlargement		6004538 00 01	Sissybar without rack	
6304557 00 05	C-Bow holder		8104559 00 91	Belly pan		5064572 00 01	Tank ring Lock-it		6114539 00 01	Solorack with pad	
5054557 00 01	Center stand		5064559 00 01	Tank ring Lock-it	904, 3:14,L5	5164572 00 01	Tank ring Basic		6004539 00 01	Solorack without pad	
8104557 00 91	Belly pan		5164559 00 01	Tank ring Basic	704, 3:14,L5	42114572 00 91	Side stand enlargement		6584538 01 01	Rear rack tube type	189
5064557 00 01	Tank ring Lock-it	904	42114559 00 91	Side stand enlargement		<b>TDM 900 / A (2002-2013)</b>			5014538 00 01	Engine guard	
5164557 00 01	Tank ring Basic	704	5014559 00 05	Engine guard incl. Protectionpad		6504502 00 01	Side carrier		7004538 00 01	Headlight grille	112
42114557 00 91	Side stand enlargement		8004559 00 01	Rear rack enlargement		6504502 01 01	Rear rack	9	42204538 00 01	Canister Cutout	
5014557 00 05	Engine guard incl. Protectionpad		<b>MT - 09 Tracer / Tracer 900 (2015-2017)</b>			6504504 01 01	Rear rack	47,9	4204538-01	Drivers backrest	
<b>MT - 09 (2021-)</b>			6504547 00 05	Side carrier Lock-it		501415 00 01	Engine guard		4204538-03	Cylinder head fender	
5014573 00 01	Engine guard		6504547 01 05	Alurack		5054502 00 01	Center stand		4204538-04	Air filter box fender	
6304573 00 01	C-Bow holder		6614547 01 05	Easyrack	118	5064502 00 01	Tank ring Lock-it	904	<b>XVS 950 A Midnight Star (2009-2015)</b>		
6524573 01 01	Alurack		6304547 00 05	C-Bow holder		5164502 00 01	Tank ring Basic	704	6504529 00 02	Side carrier	
6614573 01 01	Easyrack		5014547 00 05	Engine guard incl. Protectionpad		<b>XJ 900 F (1985-1994)</b>			6504529 01 02	Rear rack	
6604573 01 01	Minirack		8104547 00 09	Belly pan		650417 00 01	Complete carrier		6304529 00 02	C-Bow leather bag holder	
5064573 00 01	Tank ring Lock-it	904	8004547 00 01	Rear rack enlargement		650417 01 01	Rear rack	22	6254529 00 02	Leather bag holder tube type	
5164573 00 01	Tank ring Basic	704	4204547-02	Pillion footrest lowering kit	68,112	<b>SCR 950 (2017-2020)</b>			6114529 00 02	Sissybar with rack	59
42114573 00 91	Side stand enlargement		5064547 00 01	Tank ring Lock-it	904	6264556 00 01	Rugged Cutout		6004529 00 02	Sissybar without rack	59
<b>MT - 09 SP (2018-2020)</b>			5164547 00 01	Tank ring Basic	704	6544556 01 01	Rear rack tube type	27,141	6114530 00 02	Solorack with pad	59
6524558 01 05	Alurack		42114547 00 91	Side stand enlargement		5014556 00 01	Engine guard		6004530 00 02	Solorack without pad	59
6614558 01 05	Easyrack		<b>NOTE tank rings YAMAHA</b>			4204556-03	Cylinder head fender		5014529 00 02	Engine guard	
6604558 01 05	Minirack		Our tank ring Lock-it 506006-5 / Basic 516006-5 fits all Yamaha MODELS with 5 hole mounting.			4204556-04	Air filter box fender		4104529 00 02	Fender Guard	
6304558 00 05	C-Bow holder		506006-5	Tank ring Lock-it 5-hole		7004556 00 01	Headlight grille	112	4004529 00 02	Twinlight Set	
5054558 00 01	Center stand		516006-5	Tank ring Basic 5-hole		<b>MT - 10 (2016-2021)</b>			6524553 01 05	Alurack	
8104558 00 91	Belly pan		Our tank ring Lock-it 506009-7/8 / Basic 516009-7/8 fits all Yamaha MODELS with 7 or 8 hole mounting.			6614553 01 05	Easyrack		6604553 01 05	Minirack	
5064558 00 01	Tank ring Lock-it	904	506009-7/8	Tank ring Lock-it 7/8-hole		6304553 00 05	C-Bow holder		6304553 00 05	C-Bow holder	
5164558 00 01	Tank ring Basic	704	516009-7/8	Tank ring Basic 7/8-hole		5064553 00 01	Tank ring Lock-it	904	5064553 00 01	Tank ring Lock-it	904
42114558 00 91	Side stand enlargement					5164553 00 01	Tank ring Basic	704			
5014558 00 05	Engine guard incl. Protectionpad										

**ATTENTION: You can find the new 2024 models online at [www.hepco-becker.de](http://www.hepco-becker.de)**



Item-no.	Description	Info's
<b>MT - 10 (2022-)</b>		
6304577 00 05	C-Bow holder	
5064577 00 01	Tank ring Lock-it	904
5164577 00 01	Tank ring Basic	704
6524577 01 05	Alurack	
6614577 01 05	Easyrack	
6604577 01 05	Minirack	
<b>FZ 1 (2006-2015)</b>		
6504522 00 01	Side carrier Lock-it	22
6704515 00 01	Sportrack	8,52
6304522 00 01	C-Bow holder	
501420 00 01	Engine guard	
5064522 00 01	Tank ring Lock-it	904
5164522 00 01	Tank ring Basic	704
<b>FZ 1 Fazer (2006-2015)</b>		
6504522 00 01	Side carrier Lock-it	22
6504515 00 01	Side carrier	32
6504515 01 01	Alurack	106
6614515 01 01	Easyrack	106
6304515 00 01	C-Bow holder	96
501420 00 01	Engine guard	
670403 00 01	Sportrack	52
5064515 00 01	Tank ring Lock-it	904
5164515 00 01	Tank ring Basic	704
<b>NOTE tank rings YAMAHA</b>		
Our tank ring Lock-it 506006-5 / Basic 516006-5 fits all Yamaha MODELS with 5 hole mounting.		
506006-5	Tank ring Lock-it 5-hole	
516006-5	Tank ring Basic 5-hole	
Our tank ring Lock-it 506009-7/8 / Basic 516009-7/8 fits all Yamaha MODELS with 7 or 8 hole mounting.		
506009-7/8	Tank ring Lock-it 7/8-hole	
516009-7/8	Tank ring Basic 7/8-hole	

Item-no.	Description	Info's
<b>FZR 1000 (1987-1988)</b>		
650453 00 01	Complete carrier	21, 5:A,B, C,D,E, F
650453 01 01	Rear rack	22
506453 00 01	Tank ring Lock-it	907
516453 00 01	Tank ring Basic	707
<b>FZR 1000 (1989-1990)</b>		
650465 00 01	Complete carrier	21, 5:A,B, C,D,E, F
650465 01 01	Rear rack	22
506465 00 01	Tank ring Lock-it	907
516465 00 01	Tank ring Basic	707
<b>FZR 1000 (1991-1994)</b>		
650470 00 01	Complete carrier	5:A,B, C,D,E, F
650470 01 01	Rear rack	22
506470 00 01	Tank ring Lock-it	907
516470 00 01	Tank ring Basic	707
<b>FZS 1000 Fazer (2001-2005)</b>		
650431 00 01	Side carrier	
650431 01 01	Alurack	
661431 01 01	Easyrack	
501431 00 01	Engine guard	
506431 00 01	Tank ring Lock-it	904
516431 00 01	Tank ring Basic	704
<b>GTS 1000 (A) (1994-1999)</b>		
650475 00 01	Complete carrier	
506475 00 01	Tank ring Lock-it	907
516475 00 01	Tank ring Basic	707
<b>TR 1 (1981)</b>		
650418 00 01	Complete carrier	
<b>TR 1 (1982-1983)</b>		
650419 00 02	Complete carrier	
<b>XV 1000 Virago (-1991)</b>		
650447 00 02	Complete carrier	

Item-no.	Description	Info's
<b>YZF 1000 Thunder Ace (1996-2003)</b>		
650487 01 01	Rear rack	
506487 00 01	Tank ring Lock-it	907
516487 00 01	Tank ring Basic	707
<b>YZF-R1 (2000-2001)</b>		
650429 01 01	Rear rack	
506429 00 01	Tank ring Lock-it	904
516429 00 01	Tank ring Basic	704
<b>YZF-R1 (2002-2004)</b>		
6504501 01 01	Rear rack	
5064501 00 01	Tank ring Lock-it	904
5164501 00 01	Tank ring Basic	704
<b>YZF-R1 (2009-2014) (RN 22)</b>		
670401 00 01	Sportrack	52
506401 00 01	Tank ring Lock-it	904
516401 00 01	Tank ring Basic	704
<b>YZF-R1 / M (2015-)</b>		
6704545 00 01	Sportrack	52,175, 169
6304545 00 01	C-Bow holder	
5064545 00 01	Tank ring Lock-it	904
5164545 00 01	Tank ring Basic	704
<b>BT 1100 Bulldog (2001-2006)</b>		
6504503 00 01	Side carrier	53
6504503 01 01	Rear rack	53
501416 00 02	Engine guard	
5064503 00 01	Tank ring Lock-it	904
5164503 00 01	Tank ring Basic	704
<b>FJ 1100 (1984-1985)</b>		
650439 00 01	Complete carrier	5:A,B, C,D,E, F
650439 01 01	Rear rack	22
<b>XS 1100 (1977-1980)</b>		
650421 00 02	Complete carrier	
<b>XS 1100 S (1981-1982)</b>		
650422 00 01	Complete carrier	

Item-no.	Description	Info's
<b>XV 1100 Virago (1992-1999)</b>		
650464 00 02	Complete carrier	154
650464 01 02	Rear rack	22,154
650494 00 02	Complete carrier	154
650494 01 02	Rear rack	154
625464 00 02	Leather bag holder tube type	3:P,5
611403 00 02	Sissybar with rack	59
600403 00 02	Sissybar without rack	59
501406 00 02	Engine guard	
400464 00 02	Twinlight Set	
<b>XVS 1100 A Drag Star Classic (2001-2007)</b>		
650430 00 02	Side carrier	24
650430 01 02	Rear rack	
625430 00 02	Leather bag holder tube type	
410430 00 02	Fender Guard	
611430 00 02	Sissybar with rack	59
600430 00 02	Sissybar without rack	59
611412 00 02	Solorack with pad	59
600412 00 02	Solorack without pad	59
501430 00 02	Engine guard	
400430 00 02	Twinlight Set	
<b>XVS 1100 Drag Star (1999-2002)</b>		
650498 00 02	Side carrier	
650498 01 02	Rear rack	
625498 00 02	Leather bag holder tube type	3:P,5
611408 00 02	Sissybar with rack	59
600408 00 02	Sissybar without rack	59
611409 00 02	Solorack with pad	59
600409 00 02	Solorack without pad	59
501414 00 02	Engine guard	
400498 00 02	Twinlight Set	
<b>FJ 1200 (1986-1987)</b>		
650442 00 01	Complete carrier	
650442 01 01	Rear rack	59

**ATTENTION: You can find the new 2024 models online at [www.hepco-becker.de](http://www.hepco-becker.de)**



Item-no.	Description	Info's	Item-no.	Description	Info's	Item-no.	Description	Info's	Item-no.	Description	Info's
<b>FJ 1200 (1988-1990)</b>			<b>XJR 1200 / SP (1994-1998)</b>			<b>XJR 1300 (2004-2006)</b>			<b>MT - 01 (2005-)</b>		
650459 00 01	Complete carrier		650482 00 01	Complete carrier	3:C,D	6504527 00 01	Complete carrier Lock-it		6504513 01 01	Rear rack	
650459 01 01	Rear rack	59	501409 00 01	Engine guard		6504510 00 01	Complete carrier	95	5064513 00 01	Tank ring Lock-it	904
506459 00 01	Tank ring Lock-it	907	501409 00 02	Engine guard		6504510 00 02	Complete carrier	95	5164513 00 01	Tank ring Basic	704
516459 00 01	Tank ring Basic	707	506482 00 01	Tank ring Lock-it		6504510 01 01	Rear rack	22	<b>V Max (-2002)</b>		
<b>XT 1200 Z / XT 1200 ZE Super Ténéré (2014-2020)</b>			516482 00 01	Tank ring Basic		501409 00 01	Engine guard		650455 00 02	Complete carrier	
6504531 00 01	Side carrier Lock-it (-2013)		<b>XVZ 1300 Royal Star (1983-1994)</b>			501409 00 02	Engine guard		650455 01 02	Rear rack	59
6504540 00 01	Side carrier Lock-it (2014-2020)		650491 00 02	Complete carrier		5064510 00 01	Tank ring Lock-it	904	<b>XV 1600 Wild Star (1999-2004)</b>		
6504531 01 01	Alurack		650491 01 02	Rear rack		5164510 00 01	Tank ring Basic	704	650499 00 02	Side carrier	
6614531 01 01	Easyrack		625491 00 02			<b>XJR 1300 (2007-2014)</b>			650499 01 02	Rear rack	
6704531 01 01	Alurack f. pillion seat	27,52, 169	<b>FJR 1300 (2001-2005)</b>			6504518 00 01	Complete carrier Lock-it		625499 00 02	Leather bag holder tube type	
5014531 00 01	Engine guard		650448 00 01	Side carrier		6504518 01 01	Rear rack	22	611499 00 02	Sissybar with rack	59
640100 00 01	Crash bar bag set V1	143	650448 01 01	Rear rack	9	6304518 00 01	C-Bow holder		600499 00 02	Sissybar without rack	59
5024531 00 01	Tank guard	65	506448 00 01	Tank ring Lock-it	904	5014518 00 01	Engine guard		611411 00 02	Solorack with pad	59
5054540 00 01	Center stand (2014-2020)		516448 00 01	Tank ring Basic	704	5014518 00 02	Engine guard		600411 00 02	Solorack without pad	59
7004531 00 01	Headlight grille	112	<b>FJR 1300 (2006-2020)</b>			5064518 00 01	Tank ring Lock-it	904	501499 00 02	Engine guard	
731107	LED auxiliary headlights Nova	133	6504516 00 01	Side carrier		5164518 00 01	Tank ring Basic	704	400499 00 02	Twinlight Set	
8004531 00 01	Rear rack enlargement		6504516 01 01	Rear rack	9	<b>XJR 1300 (2015-)</b>			400496 00 02	Twinlight Set	67
8104531 00 12	Skid plate	74	5064516 00 01	Tank ring Lock-it	904	6504546 01 01	Alurack		<b>XV 1900 Midnight Star (2006-2016)</b>		
42224531 00 01	Adapterkit for the combination of the original Yamaha crash bar with H&B skid plate		5164516 00 01	Tank ring Basic	704	6614546 01 01	Easyrack		6504517 00 02	Side carrier	
4204531-01	Kardan sleeve protection		<b>XJR 1300 (1999-2003)</b>			6304546 00 01	C-Bow holder		6304517 00 02	C-Bow leather bag holder	
4204531-02	Water pump protection		650482 00 01	Complete carrier	3:C,D	5014546 00 01	Engine guard		6254517 00 02	Leather bag holder tube type	
4204531-04	Break fluid reservoir guard		650482 01 01	Rear rack	22	5014546 00 02	Engine guard		6114517 00 02	Sissybar with rack	59
4204540-01	Handle guard (2014-2020)		501409 00 01	Engine guard		<b>XVS 1300 Midnight Star (2007-2016)</b>			6004517 00 02	Sissybar without rack	59
5064531 00 01	Tank ring Lock-it	904	501409 00 02	Engine guard		6504519 00 02	Side carrier	160	5014517 00 02	Engine guard	
5164531 00 01	Tank ring Basic	704	506409 00 01	Tank ring Lock-it	904	6504519 01 02	Rear rack	160	4004517 00 02	Twinlight Set	
<b>FJ 1200 / FJ 1200 (A) (1991-1995)</b>			516409 00 01	Tank ring Basic	704	6254519 00 02	Leather bag holder tube type		<b>NOTE tank rings YAMAHA</b>		
650471 00 01	Complete carrier		650482 00 01			6114519 00 02	Sissybar with rack	59,160	Our tank ring Lock-it 506006-5 / Basic 516006-5 fits all Yamaha MODELS with 5 hole mounting.		
650471 01 01	Rear rack	59	650482 01 01			6004519 00 02	Sissybar without rack	59,160	506006-5	Tank ring Lock-it 5-hole	
506471 00 01	Tank ring Lock-it	907	501409 00 01			6114521 00 02	Solorack with pad	59	516006-5	Tank ring Basic 5-hole	
516471 00 01	Tank ring Basic	707	501409 00 02			6004521 00 02	Solorack without pad	59	Our tank ring Lock-it 506009-7/8 / Basic 516009-7/8 fits all Yamaha MODELS with 7 or 8 hole mounting.		
			506409 00 01			5014519 00 02	Engine guard		506009-7/8	Tank ring Lock-it 7/8-hole	
			516409 00 01			4004519 00 02	Twinlight Set		516009-7/8	Tank ring Basic 7/8-hole	

**ATTENTION: You can find the new 2024 models online at [www.hepco-becker.de](http://www.hepco-becker.de)**



Info reference see p. 271

The last digit of the item-no. refers to the colours: 01= black 02= chrome 03= white 04= red 05= anthracite 06= orange 08= yellow 09= silver 10= blue metallic 12= Alu brushed 22= Stainless steel 91= silver/black

# OTHERS

Item-no.	Description	Info's
<b>BENELLI</b>		
<b>TRK 502 (2017-)</b>		
6537594 00 01	Side carrier	
6527594 01 01	Alurack	
6617594 01 01	Easyrack	
6607594 01 01	Minirack	
<b>TRK 502 X (2018-)</b>		
6537595 00 01	Side carrier	0
6527595 01 01	Alurack	
6617595 01 01	Easyrack	
6607595 01 01	Minirack	
<b>Leoncino 800 (2022-)</b>		
6307645 00 01	C-Bow holder	
5067645 00 01	Tank ring Lock-it	904
5167645 00 01	Tank ring Basic	704

## BUELL

<b>Lightning XB 9 SX (2002-2003)</b>		
650703 00 01	Side carrier Lock-it	27,256
650734 00 01	Side carrier Lock-it	27,257
<b>Lightning XB 12 (2003-2009)</b>		
650703 00 01	Side carrier Lock-it	27,256
650734 00 01	Side carrier Lock-it	27,257
<b>XB 12 Ulysses (2006-2010)</b>		
650799 00 01	Side carrier	139
650799 01 01	Rear rack	139

## CAGIVA

<b>Alazzurra 350 (1984-1986)</b>		
650712 00 01	Complete carrier	
<b>Elefant 350 (1985-1986)</b>		
650713 00 01	Side carrier	0
<b>Alazzurra 650 (1985-1986)</b>		
650712 00 01	Complete carrier	

<b>Raptor 650 (2000-2007)</b>		
650772 01 01	Rear rack	
506772 00 01	Tank ring Lock-it	900
516772 00 01	Tank ring Basic	700
<b>Elefant 750 (-1986)</b>		
650713 00 01	Side carrier	0
<b>Elefant 750 i.e./GT/AC (1994-1996)</b>		
650728 00 01	Side carrier	0
650728 01 01	Rear rack	9
501702 00 01	Engine guard	
506728 00 01	Tank ring Lock-it	900
516728 00 01	Tank ring Basic	700
<b>Elefant 900 i.e. (1990-1992)</b>		
650721 00 01	Side carrier	0
506721 00 01	Tank ring Lock-it	904
516721 00 01	Tank ring Basic	704
650721 01 01	Rear rack	50; 3: B, E
501702 00 01	Engine guard	
<b>Gran Canyon 900 (1998-2000)</b>		
650753 00 01	Side carrier	
650753 01 01	Rear rack	9
501704 00 01	Engine guard	
<b>Elefant 900 i.e./GT (1993-1997)</b>		
650728 00 01	Side carrier	0
650728 01 01	Rear rack	9
501702 00 01	Engine guard	
506728 00 01	Tank ring Lock-it	
516728 00 01	Tank ring Basic	
<b>Navigator (2000-2005)</b>		
650770 00 01	Side carrier	
650770 01 01	Rear rack	9
501705 00 01	Engine guard	
<b>Raptor 1000 (2000-2005)</b>		
650772 01 01	Rear rack	
506772 00 01	Tank ring Lock-it	
516772 00 01	Tank ring Basic	

<b>CF-MOTO</b>		
<b>650 NK (2016-)</b>		
5067642 00 01	Tank ring Lock-it	918
5167642 00 01	Tank ring Basic	718
<b>700 CL-X (2022-)</b>		
5067643 00 01	Tankring Lock-it	918
5167643 00 01	Tankring Basic	718
5047643 00 01	Rear guard	
5037643 00 01	Front guard	
5017643 00 01	Engine guard	
6307643 00 01	C-Bow holder	

### NOTICE Tank rings CF-MOTO

Our tank ring Lock-it 506019-5 / Basic 516019-5 fits all CF-MOTO models with 5 hole mounting.

506019-5	Tank ring Lock-it 5 hole
516019-5	Tank ring Basic 5 hole

## GENERIC

### XOR 50 / XOR 125 (2008-)

650840 01 01	Rear rack
--------------	-----------

## HUSQVARNA

### TR 650 Terra / Strada (2013-)

6507521 01 01	Alurack	
6617521 01 01	Easyrack	
<b>Nuda 900 (2012-2014)</b>		
6507511 01 01	Minirack	72
6307511 00 01	C-Bow holder	
5027511 00 01	Engine guard	

<b>Norden 901 / Expedition (2022-)</b>		
6537634 00 01	Side carrier	
6517634 00 22-01-40	Xplorer Cutout Set Black	
6517634 00 22-00-40	Xplorer Cutout Set Silver	
6517634 00 22	Cutout carrier	
6307634 00 01	C-Bow holder	
5067634 00 01	Tank ring Lock-it	
5167634 00 01	Tank ring Basic	
6557634 01 01	Alurack f. original rack	
6627634 01 01	Easyrack f. original rack	
8007634 00 01	Rear rack enlargement	
5017634 00 01	Engine Guard	
5017634 00 22	Engine Guard	
5017634 00 08	Engine Guard	
5027634 00 01	Engine Guard Solid	
5027634 00 08	Engine Guard Solid	
5027634 00 03	Engine Guard Solid	
640100 00 01	Crash bar bag set V1	
42267634 00 01	Additional plate f. original skid plate	231
7007634 00 01	Headlight grilles	
7017634 00 01	Protective screen	
42127634 00 01	Handle guard	
42117634 00 91	Side stand enlargement	
741100 00 01	Tool box	
731107	LED auxiliary headlights Nova	133



**ATTENTION: You can find the new 2024 models online at [www.hepco-becker.de](http://www.hepco-becker.de)**



# OTHERS

Item-no.	Description	Info's
<b>HYOSUNG</b>		
<b>GT 125 / 250 (2003-2008)</b>		
650778 01 01	Rear rack	
<b>GT 650 Naked (2004-2007)</b>		
650778 01 01	Rear rack	
501709 00 01	Engine guard	
<b>GV 650 i Aquila (2006-2011)</b>		
650793 01 02	Rear rack	
630793 00 02	C-Bow holder	
611793 00 02	Sissybar with rack	59
600793 00 02	Sissybar without rack	59

## INDIAN

Item-no.	Description	Info's
<b>Scout / Sixty (2015-)</b>		
6307561 00 01	C-Bow holder	154,164, 3:H
6307561 00 02	C-Bow holder	154,164, 3:H
5017561 00 01	Engine guard	
5017561 00 02	Engine guard	
6137561 00 01	Solorack	
6137561 00 02	Solorack	
42197561 00 01	Railing	96
42197561 00 02	Railing	96
5067561 00 01	Tank ring Lock-it	4: L1,L2,M1
5167561 00 01	Tank ring Basic	4: L1,L2,M1
<b>Scout Bobber/ Sixty/ Twenty/ Rogue (2017-)</b>		
5017568 00 02	Engine guard	
5017568 00 01	Engine guard	
6137568 00 01	Solorack	221
6127568 00 01	Solorack with backrest	221
6267568 00 01	Rugged Cutout	4:R2
5067568 00 01	Tank ring Lock-it	4: L1,L2,M1
5167568 00 01	Tank ring Basic	4: L1,L2,M1
42167568 00 01	Backrest	148,221
42207568 00 01	Canister cutout set (one sided left)	

Item-no.	Description	Info's
<b>FTR 1200 / S / R Carbon / Rally (2019-)</b>		
6317580 00 01L	C-Bow holder, one-sided, left	
6587580 01 01	Rear rack tube type	141
<b>Chief Dark Horse / Chief Bobber Dark Horse / Super Chief Limited (2022-) / Sport Chief (2023-)</b>		
6307641 00 01	C-Bow holder	258,4: K1,Q1
6137641 00 01	Solorack without backrest	258
6127641 00 01	Solorack with backrest	258
42167641 00 01	Backrest for Solorack	148, 258
5017641 00 01	Engine Guard	
4007641 00 01	Twinlight Set (not f. Sport Chief)	

## KYMCO

Item-no.	Description	Info's
<b>Xciting S 400i ABS (2019-)</b>		
6527570 01 01	Alurack	
6617570 01 01	Easyrack	
6607570 01 01	Minirack	

## LAVERDA

Item-no.	Description	Info's
<b>1000 RGS (1983)</b>		
650706 00 01	Complete carrier	
<b>Jota 1000 (1980)</b>		
650705 00 01	Complete carrier	
<b>Jota 1200 (1981)</b>		
650705 00 01	Complete carrier	

## MALAGUTI

Item-no.	Description	Info's
<b>Madison 125 / 250 / 400 (1999-2011)</b>		
650836 01 01	Rear rack	

Item-no.	Description	Info's
<b>MASH</b>		
<b>X-Ride 650 Classic (2020-)</b>		
5017611 00 01	Engine guard	
7007611 00 01	Headlight grilles	112
<b>MONDIAL</b>		
<b>SMX 125i Enduro CBS / Supermoto CBS (2019-)</b>		
6607607 01 01	Minirack	
6527607 01 01	Alurack	
6617607 01 01	Easyrack	

## MOTO MORINI

Item-no.	Description	Info's
<b>Granpasso 1200 (2008-2011)</b>		
650749 00 01	Side carrier Lock-it	0
650749 01 01	Alurack	
661749 01 01	Easyrack	

## MV AGUSTA

Item-no.	Description	Info's
<b>Brutale 675 / 800 (2012-2016)</b>		
6507522 01 01	Alurack	
6617522 01 01	Easyrack	
6307522 00 01	C-Bow holder	
5067522 00 01	Tank ring Lock-it (2014-)	900
5167522 00 01	Tank ring Basic (2014-)	700

### NOTICE Tank rings MV AGUSTA

Our tank ring Lock-it 506001-6 / Basic 516001-6 fits all MV AGUSTA models with 6 hole mounting.

506001-6	Tank ring Lock-it 6-hole
516001-6	Tank ring Basic 6-hole

Item-no.	Description	Info's
<b>MZ</b>		
<b>ETZ 250 (1981-1990)</b>		
650709 00 02	Complete carrier	
<b>ETZ 251 (1989-1997)</b>		
650717 00 02	Complete carrier	8
<b>Country (1993-1998)</b>		
650743 00 01	Side carrier	
<b>500 R Classic (1991-1992)</b>		
650729 00 01	Complete carrier	
<b>Silver Star Classic 500 (1992-1997)</b>		
650738 00 02	Complete carrier	
650738 01 02	Rear rack	
<b>Mastiff / Baghira (1997-2005)</b>		
650762 01 01	Rear rack	
<b>Scorpion Tour (1994-2002)</b>		
650741 00 01	Complete carrier	

## PEUGEOT

Item-no.	Description	Info's
<b>Speed Fight 2 50 AC (1997-2009)</b>		
650837 01 01	Rear rack	13
<b>Speedfight 3 (2009-2015)</b>		
650842 01 01	Rear rack	13
<b>100 X-Race (1997-2007)</b>		
650837 01 01	Rear rack	13

## PIAGGIO

Item-no.	Description	Info's
<b>Hexagon (1994-2003)</b>		
650809 00 01	Side carrier	32
650809 01 02	Rear rack	
650809 01 01	Rear rack	
<b>Beverly 125 / 200 / 500 (2009-2012)</b>		
650834 01 01	Rear rack	13
<b>X9 125-500 (2003-2009)</b>		
650835 01 01	Rear rack	



**ATTENTION: You can find the new 2024 models online at [www.hepco-becker.de](http://www.hepco-becker.de)**



Info reference see p. 271

The last digit of the item-no. refers to the colours: 01= black 02= chrome 03= white 04= red 05= anthracite 06= orange 08= yellow 09= silver 10= blue metallic 12= Alu brushed 22= Stainless steel 91= silver/black

# OTHERS

Item-no.	Description	Info's
<b>MP3 350 (2018-)</b>		
6307604 00 01	C-Bow holder	
6557604 01 01	Alurack	
6627604 01 01	Easyrack	
<b>MP3 500 (2015-)</b>		
6307596 00 01	C-Bow holder	
6557596 01 01	Alurack (2015-2021)	
6627596 01 01	Easyrack (2015-2021)	
<b>MP3 Exclusive 530 (2022-)</b>		
6307650 00 01	C-Bow holder	
6557650 01 01	Alurack	
6627650 01 01	Easyrack	
<b>MP3 400 / MP3 Sport 400 (2022-)</b>		
6307652 00 01	C-Bow holder	
6557652 01 01	Alurack	
6627652 01 01	Easyrack	

## ROYAL ENFIELD

<b>Meteor 350 (2021-)</b>		
6307619 00 01	C-Bow holder	
6307619 00 02	C-Bow holder	
6587619 01 01	Rear rack tube type	141
<b>Classic 350 (2022-)</b>		
6307633 00 01	C-Bow holder	
6307633 00 02	C-Bow holder	
6587633 01 01	Rear rack tube type	189,192
6547633 01 01	Rear rack tube type	27,189
6547633 01 02	Rear rack tube type	27,189
5017633 00 01	Engine guard	
<b>HNTR 350 (2023-)</b>		
6307635 00 01	C-Bow holder	
6587635 01 01	Rear rack tube type	189
7007635 00 01	Headlight grille	112
5017635 00 01	Engine guard	

Item-no.	Description	Info's
<b>Scram 411 (2022-)</b>		
6307646 00 01	C-Bow holder	
6587646 01 01	Rear rack tube type	189
5067646 00 01	Tank ring Lock-it	
5167646 00 01	Tank ring Basic	
5017646 00 01	Engine guard	
7007646 00 01	Headlight grille	
<b>Bullet Classic (2009-)</b>		
630715 00 01	C-Bow holder	
<b>Continental GT (2013-2018)</b>		
6607534 01 01	Mini- Rear rack	10,100
6307534 00 01	C-Bow holder	
<b>Interceptor 650 (2018-) / Continental GT 650 (2019-)</b>		
6307571 00 01	C-Bow holder	170, 3:H,K2, P,S
6307571 00 02	C-Bow holder	170, 3:H,K2, P,S
6547571 01 01	Rear rack	
6547571 01 02	Rear rack	
5017571 00 02	Engine guard	
42157571 00 01	Pillion footrest relocation kit	50,233
<b>Super Meteor 650 (2023-)</b>		
6307651 00 01	C-Bow holder	214
6117651 00 01	Sissybar with rack	223,227
6007651 00 01	Sissybar without rack	223,227
6547651 01 01	Rear rack tube type	223,227, 3:B3
6137651 00 01	Solorack	227
42167651 00 01	Drivers Backrest	148, 227
7007651 00 01	Headlight grille	112, 227
5017651 00 01	Engine guard	
5017651 00 02	Engine guard	

Item-no.	Description	Info's
<b>Himalayan (2018-)</b>		
6537590 00 01	Side carrier	161,162, 75
6307590 00 01	C-Bow holder	
5067590 00 01	Tank ring Lock-it	
5167590 00 01	Tank ring Basic	
6557590 01 01	Alurack f. original rack (2018-2020)	
6627590 01 01	Easyrack f. original rack (2018-2020)	
6557629 01 01	Alurack f. original rack (2021-)	
6627629 01 01	Easyrack f. original rack (2021-)	
42257590 00 22	Heatshield f. case	
640100 00 01	Crash bar bag set V1	159

## VICTORY

<b>Kingpin (2003-2016)</b>		
630721 00 01	C-Bow leather bag holder	
630721 00 02	C-Bow leather bag holder	
501721 00 02	Engine guard	
611721 00 02	Sissybar with rack	59
600721 00 02	Sissybar without rack	59

## VOGE

<b>300 AC (2021-)</b>		
5067621 00 01	Tank ring Lock-it	
5167621 00 01	Tank ring Basic	

Item-no.	Description	Info's
<b>500 R (2020-)</b>		
6307609 00 01	C-Bow holder	
5067609 00 01	Tank ring Lock-it	
5167609 00 01	Tank ring Basic	
6527609 01 01	Alurack	
6617609 01 01	Easyrack	
6607609 01 01	Minirack	
5017609 00 01	Engine guard	
<b>500 AC (2022-)</b>		
5067637 00 01	Tank ring Lock-it	
5167637 00 01	Tank ring Basic	
<b>500 DS / X (2020-)</b>		
5067620 00 01	Tank ring Lock-it	
5167620 00 01	Tank ring Basic	
<b>650 DSX (2022-)</b>		
5067649 00 01	Tank ring Lock-it	
5167649 00 01	Tank ring Basic	



**ATTENTION: You can find the new 2024 models online at [www.hepco-becker.de](http://www.hepco-becker.de)**



# GENERAL / SPECIFIC NOTES

Our accessories are designed for the standard condition of the motorcycle.

- 0 Asymmetrical side carrier. Recommendation: use narrower cases on the exhaust side. e.g. 30 L & 40 L in combination.
- 1 Limitations in combination with Topcase. Please follow the installation instructions.
- 2 Recommendation for:
- 3 Not suitable for:
- 4 Only suitable for:
- 5 Limitations of the legroom with:

## A Junior included:

- A1 Junior / Flash 30
- A2 Junior / Flash 40

## B Alu Standard included:

- B1 Alu Standard 35
- B2 Alu Standard 40
- B3 Alu Standard Topcase 35

## C Xplorer included:

- C1 Xplorer 30
- C2 Xplorer 40
- C3 Xplorer 40 Cutout
- C4 Xplorer 37 Cutout

## D Xceed

## E Gobi

## F Journey 42

## G Orbit Sidecase

## H Xtravel

## I Royster Speed

## J Street

## K Legacy included:

- K1 Legacy Kuriertasche M
- K2 Legacy Kuriertasche L
- K3 Legacy Aktentasche

## L Street included:

- L1 Street Daypack
- L2 Street Tourer M
- L3 Street Tourer L
- L4 Street Tourer XL
- L5 Street Tourer Enduro
- L6 Street Enduro M

6 Original turn signals cannot be used. The same turn signals as in the front can be used. These turn signals are identical in construction with the turn signals for CB 750/900F.

7 Suitable from model year 2016 with plastic attachment on helmet compartment (see installation instruction).

## M Royster included:

- M1 Royster Daypack
- M2 Royster Tankbag

## N Legacy Tankbag

## O Nevada

## P Buffalo included:

- P1 Buffalo / Buffalo Custom
- P2 Buffalo Big / Buffalo Big Custom

## Q Liberty included:

- Q1 Liberty
- Q2 Liberty Big

## R Rugged included:

- R1 Rugged
- R2 Rugged Cutout

## S Ivory

## T Royster Neo

## U Epic included:

- U1 Epic 3
- U2 Epic 6
- U3 Epic 11 Belt
- U4 Epic 13
- U5 Epic 16
- U6 Epic 11

- 8 Please specify year of manufacture when ordering.
- 9 Our rear rack is mounted on the original rack. The HEPCO&BECKER topcases equipped with metal retaining lock can be mounted on it.
- 10 Not suitable for Lock-it rear bag adapters.
- 11 On the left side different side carriers for chain and Beltdrive.
- 12 Can be combined with original and H&B center stand.
- 13 Rear rack only suitable for Journey Topcases 30 and 40 with universal adapter plate (610089 or 610206).
- 14 For model with plastic hump behind the seat.
- 15 For model without plastic hump behind the seat.
- 16 For model with two suspension struts.
- 17 For model with central shock absorber.
- 18 The rear turn signals cannot be used. New turn signals are included in the kit.
- 19 The complete carrier is designed for standard exhaust height.
- 20 Carrier fits for single and double seat.
- 21 Exhaust silencer may have to be lowered a bit.
- 22 Single rear rack cannot be combined with the side carrier.
- 23 Required when mounting the side carrier without rear rack.
- 24 For mounting without rear rack 4219992 00 05 is required.
- 25 Only Xplorer case 30/30.
- 26 Only Junior / Flash 30/30.
- 27 Only suitable for solo use.
- 28 Not suitable for Eldorado with split seat.
- 29 Only in combination with rear guard.
- 30 Alu Standard as well as Junior side cases cannot be combined with Alu Standard Topcase 45, Junior TC 55 and Journey TC 50/52.
- 31 Please specify if a side carrier or a rear rack from H&B is already installed!
- 32 Side carrier can only be mounted in connection with the rear rack.
- 33 Only the Journey topcase 30 or 40 can be mounted in connection with side cases.
- 34 Please specify if a backrest is available.
- 35 Rear rack not suitable for topcase; compatible with original sissybar.
- 36 One-sided side carrier.
- 37 For model without Honda original rear rack.
- 38 Turn signals included.
- 39 For model with cast wheels.
- 40 For model with spoked wheels.
- 41 Only in combination with modified tank guard 502994 (Please observe mounting instructions).
- 42 For model with double exhaust system.
- 43 For model with 4in1 exhaust system.
- 44 Not in combination with original auxiliary headlights.
- 45 For model with small tank.
- 46 For model with Sebring exhaust system.

- 47 In combination with original side carrier.
- 48 Only in combination with original sissybar.
- 49 Symmetrical complete side carrier/ side carrier for model with 2in2 exhaust system.
- 50 In Germany, registration (individual approval) is required at the TÜV.
- 51 Rear rack cannot be combined with BMW original carrier.
- 52 Luggage carrier instead of the pillion seat.
- 53 Side case GOBI and top case GOBI cannot be mounted together.
- 54 Rear rack suitable for one-man seat. Suitable for top case.
- 55 Combination of Xplorer side cases with Xplorer TC60 is not possible.
- 56 Can be combined with original cases.
- 57 For model with single-sided swing arm.
- 58 For model with double swing arm.
- 59 Sissybar/Solorack can be combined with H&B side carrier and C-Bow holder for this model.
- 60 Sissybar can be combined with H&B side carrier for this model.
- 61 Not suitable in combination with 5014564
- 62 For model with two-man seat.
- 63 Not compatible with original BMW topcase plastic adapter.
- 64 Cannot be combined with 6542535! Can only be combined with 6502535 01 02.
- 65 Not mountable alone, only in combination with H&B engine/tank guard for this model.
- 66 Can only be fitted with or on the side carrier 6532535 00 02.
- 67 Twilight set for models with windshield.
- 68 Not combinable with original side carrier / side cases!
- 69 Mounting instead of the original rear rack.
- 70 Model from 08/09 on with welded footrests.
- 71 Rear rack only suitable for top case with universal adapter plate (610089, 610087 or 610206).
- 72 Mini rear rack only suitable for luggage rolls / bags. No topcase mounting possible!
- 73 Alurack available as optional accessory for topcase mounting.
- 74 Cannot be combined with original Yamaha engine guards. Adapter kit 700007408 required.
- 75 Using Xplorer side cases with Xplorer Topcase: Side case lid cannot be opened.
- 76 Engine guard (502404) cannot be mounted if the original skid plate is mounted.
- 77 Alurack, Easyrack or rear rack with C-Bow holder cannot be combined.
- 78 Specify which footrest system (black or silver) is installed.
- 79 Not for lowered version.
- 80 Not suitable for model with long seat.
- 81 Not suitable for model with short seat.
- 82 Also suitable for use with the original windshield or short windshield.

83 Can only be mounted in combination with original hand protector.

84 Max. payload 3Kg

85 Pillion handle not applicable.

86 Can also be combined with original rear rack.

87 Legacy courier bag L / Xtravel only possible in combination with vertical C-Bow shifting.

88 Can be combined with original side carrier.

89 With bags mounted, pillion passenger suitability is limited

90 Alu Standard side case cannot be combined with top case.

91 With top loader side cases the lid cannot be opened when top case is mounted.

92 Mounting of universal rear rack enlargement or top cases with pallet not possible!

93 Not compatible with original windshield.

94 Can only be mounted in combination with original engine guard.

95 Firmly screwed to the motorcycle frame (no Lock-it system).

96 Not mountable together with rear rack/Alurack/Easyrack.

97 Also for model with double clutch transmission.

98 Mounting rear right incl. crash pad head.

99 Use of lockable Lock-it screws not possible.

100 Max. payload 3Kg; not suitable for topcase.

101 If the original Honda front spoiler is mounted, the radiator grille cannot be mounted.

102 Not combinable with original Sissybar.

103 Not combinable with the engine guard.

104 Only in combination with original rear rack.

105 Not mountable together with tube-leather bag holder.

106 Not mountable together with C-Bow holder.

107 Only Junior Topcase 40 fits in combination with the Junior cases.

108 Only Journey Topcase 40 / 50 suitable in combination with the Journey side cases.

109 Not to be combined with rear rack 650284 01 02 / 01 01.

110 Not suitable for model with LED headlight; suitable is 700671.

111 The legroom for the pillion rider may be restricted.

112 There is no ABE or TÜV approval for this product in Germany.

113 Due to the seating position, topcase mounting or luggage rack extension is not possible.

114 Not compatible with the original removable sissybar.

115 Not compatible with Sportrack.

116 Only mountable in combination with H&B tank guard or the holding adapter.

117 Mounting / substructure in silver, Easyrack in black.

118 Mounting / substructure in anthracite, Easyrack in black.

119 Not combinable with original tank guard.

120 Can be combined with original engine guard / can be mounted alone.

121 The handle guard was developed in the „Road“ handlebar setting.

122 Can only be mounted in connection with the Hepco&Becker rear rack/ Alurack/ Easyrack.

123 Can only be mounted in connection with short rear.

124 Side carrier is coated black.

125 Bracket/base in red, Easyrack/Alurack in black.

126 Not suitable "Smallbag with quick release fastener"; only belt fastening possible.

127 For plastic tank.

128 For metal tank.

129 Only in combination with engine guard.

130 Load capacity max. 3 Kg / side.

131 Can only be mounted in connection with the tank guard or with special adapter.

132 Not for model with double clutch transmission.

133 Can be mounted universally on tank or engine guard.

134 Required when using the Rugged panniers - optional C-Bow installation (710630).

135 For ABS model with black footrest system.

136 Mounting only possible in connection with side carrier, otherwise article 4226994 00 01/42269510 00 01 (retaining set for support strut) is required.

137 Retaining set is required for assembly without side carrier.

138 Only suitable for side carrier Cutout.

139 Without screw set! Inch screws are available at Harley dealers.

140 Not suitable for US versions.

141 For top-case installation, only suitable for models with universal pallet.

142 Combination of Junior side case and Junior top case 55 not possible!

143 Only mountable without tank guard!

144 Optional shift lever does not fit with the DCT gearbox in combination with the H&B engine guard.

145 Only for model with dual clutch transmission (DCT).

146 Strayker cases cannot be combined with top case.

147 Only mountable in combination with H&B Alu-/ Easy-/ Minirack or pillion handle.

148 Only in combination with Solorack.

149 Pillion passenger suitability is limited. For increased legroom, we recommend the C-Bow holder shifting 710630 00 01/02.

150 Cannot be combined with Hepco&Becker center stand.

151 Only suitable for side carrier Lock-it / firmly screwed

152 Recommendation: Install the optional support bracket.

153 Only suitable for models with mounting on the tank cover and for models with carbon cover.

154 Can also be mounted in combination with the original Sissybar.

155 Enlarged version.

156 Recommendation: Mounting of the heat protection plate.

157 Only for mounting on original accessory rear rack (tour package).

158 Not mountable in combination with original Navi mount.

159 Only mountable in combination with the original tank guard.

160 Side carrier can not be combined with sissybar and rear rack.

161 Turn signals must be moved: Please follow the instructions.

162 Heat shield recommended.

163 Not suitable for LED headlights.

164 When using the legacy bags only size "M" can be used on the exhaust side.

165 Only for lowered version.

166 Only for LED version.

167 Not suitable for the "Urban" models.

168 Only in combination with complete side carrier.

169 Sportrack firmly screwed on.

170 The model-specific pillion footrest installation is necessary for driving with pillion.

171 Cannot be combined with original engine spoiler/ skid plate.

172 In combination with accessory exhaust SC-Project & ZARD possible.

173 Xtravel C-Bow / Legacy courier bag L only in combination with extension set 40mm Item-no. 710633 00 01.

174 Not suitable for the Street Model with wide chrome turn signals.

175 Not compatible with GPS tracker.

176 Not suitable for the S-Version.

177 Only for Rally / Pro model.

178 Not compatible with C-Bow horizontal or vertical installation.

179 Can be combined with original auxiliary headlights, 4213668 00 01 is required for this.

180 Depending on the model variant, the side stand must be folded out to be jacked up onto the center stand.

181 Xtravel C-Bow / Legacy courier bag L only possible in combination with vertical C-Bow shifting 710632 00 01.

182 Not in combination with original rack.

183 In combination with original rack 655/6629522 01 01 fits.

184 Mounting only possible in conjunction with Sportrack

185 Please specify the item no. of the protection guard or brand/ model/ year of construction when ordering.

186 Restrictions with original rack: With Xplorer cases, the lid cannot be opened. Alu Standard not possible.

187 Combination with rear guard possible.

188 Pad brown, metal black glossy

189 Not for topcases.

190 Combination of Junior side case and Junior TC 40 not possible!

191 The engine guard is not suitable for the valve cover "Option 719"

192 Only in combination with pillion seat.



# GENERAL / SPECIFIC NOTES

193	Also suitable in combination with original auxiliary headlights / fog lights. For this Art.Nr. 42269537 00 01 necessary.	221	Not suitable with seat variant Syndicate	264	Original parts from the pillion seat are used!
194	Not suitable in front footrest position	222	Only fits with the original handles.	265	Only in combination with original BMW plastic hand guard. Can also be fitted with original BMW sat nav preparation.
195	Also suitable for the shock absorber version with expansion tank.	223	Not suitable for Touring double seat.	266	Not suitable for the comfort handlebar.
196	For increased load we recommend item no. 710153.	224	Not for XT model.	267	If the original rear rack or the top case carrier is omitted, we recommend the additional fitting of the original cover for the rear frame. The parts are available from your BMW dealer under the following spare part numbers: 1x rear frame cover: 46637106015 and 2x clips: 52105A09840
197	Only for original top case incl. original cover.	225	For XT model.	268	Also suitable with the rear rack, handlebar or top case carrier from BMW.
198	Only for original cases	226	Only for XT model.	269	Epic 16 fits with article 710506001.
199	In combination with the original rack or the side bags Xtravel / Legacy courier bag L / Royster Neo / Street the widening set 40mm item no. 710633 00 01 is necessary.	227	Not for Celestial.		
200	To open the on-board tool box, the holder on the left must be removed.	228	Not for F model.		
201	Only suitable for „off“ handlebar position.	229	In combination with the side cases Alu Standard, these must be removed for opening.		
202	The function of the foot brake lever must be checked after assembly, adjust the position if necessary.	230	Not for S / R models.		
203	Not in combination with side carrier.	231	Not for Norden 901 Expedition.		
204	Combinable with headlight grilles (7009525 / 701998). Not compatible with original touring windshield/ Headlight cover.	232	Only for Tuono V4 Factory		
205	Also suitable with original tank guard.	233	Not for Continental GT 650		
206	Not in combination with skid plate from DUCATI.	234	Single cylinder		
207	Not suitable with original accessory rack. Only suitable in combination with H&B rear rack or optionally available pillion handle. Original pillion handle not necessary.	235	Only for HP seat.		
208	Required when mounting the C-Bow holder without rear rack.	236	Not for HP seat.		
209	The pillion suitability is limited when the bags are mounted. In combination with Royster Neo and Xtravel bags we recommend the vertical C-Bow installation 720630 00 01	237	Only for Desert Sled.		
210	Only in combination with H&B tank guard. Can also be combined with 42237638.	238	Not for Desert Sled.		
211	Can only be mounted in combination with the H&B tank guard.	239	Also for GT model.		
212	Not in combination with Minirack or Sportrack.	240	Not suitable for S version with lamp cover.		
213	Not suitable for model SE.	241	Only suitable for Hepco&Becker center stand.		
214	In combination with the original sissy bar, the widening set 710632 00 01 is required.	242	Also suitable for DSG (automatic gearbox)		
215	Is needed if no original tank guard or engine guard is mounted.	243	Not for Racer model.		
216	Only possible in combination with 5019539	244	Not for Sport model.		
217	Only possible in combination with 5029539	245	Not for XRX model.		
218	Also suitable with original engine guard.	246	Not for GT / GT Pro / GT Low (2020-), Rally / Pro (2021-).	700	Same as universal tank ring 516001-6
219	Can be combined with engine guard 5019539 or original engine guard. The adapter set 42139539 is required for: Mounting of 5029539 with/or 5019539. The adapter set 42139539 is not required for: Mounting on an already installed engine guard (Hepco&Becker or original).	247	Only for 20L tank.	701	Same as universal tank ring 516002-5
220	Can be combined with tank guard 5029539 or original tank guard. The adapter set 42139539 is required for: Installation of 5019539 with/or 5029539. The adapter set 42139539 is not required for: Mounting on an already installed tank guard (Hepco&Becker or original).	248	Only for GT / GT Pro model.	702	Same as universal tank ring 516003-6
		249	Not for Commander / LT model.	703	Same as universal tank ring 516005-0
		250	Not for LT model.	704	Same as universal tank ring 516006-5
		251	Not for Commander / LT / Storm model.	705	Same as universal tank ring 516007-7
		252	Only for XJ 6 model.	706	Same as universal tank ring 516008-7
		253	Not for Xtribute model.	707	Same as universal tank ring 516009-7/8
		254	Not for Rally model.	708	Same as universal tank ring 516010-5
		255	Not for GT model.	709	Same as universal tank ring 516011-7
		256	Long rear.	710	Same as universal tank ring 516012-5
		257	Short rear.	711	Same as universal tank ring 516013-5
		258	Not for Super Chief Limited model.	712	Same as universal tank ring 516014-5
		259	Only for Tiger 900/GT/GT Pro/GT Low (2020-)	713	Same as universal tank ring 516015-0
		260	Only for Tiger 900 Rally / Pro (2021-)	714	Same as universal tank ring 516016-7
		261	Nur für Tiger 900 Rally / Pro (2020)	715	Same as universal tank ring 516017-4
		262	Also suitable with original valve cover guard	716	Same as universal tank ring 516992-5
		263	Suitable in combination with side cases.	717	Same as universal tank ring 516018-7
				718	Same as universal tank ring 516019-5
				719	Same as universal tank ring 516020-0

900	Same as universal tank ring 506001-6
901	Same as universal tank ring 506002-5
902	Same as universal tank ring 506003-6
903	Same as universal tank ring 506005-0
904	Same as universal tank ring 506006-5
905	Same as universal tank ring 506007-7
906	Same as universal tank ring 506008-7
907	Same as universal tank ring 506009-7/8
908	Same as universal tank ring 506010-5
909	Same as universal tank ring 506011-7
910	Same as universal tank ring 506012-5
911	Same as universal tank ring 506013-5
912	Same as universal tank ring 506014-5
913	Same as universal tank ring 506015-0
914	Same as universal tank ring 506016-7
915	Same as universal tank ring 506017-4
916	Same as universal tank ring 506992-5
917	Same as universal tank ring 506018-7
918	Same as universal tank ring 506019-5
919	Same as universal tank ring 506020-0

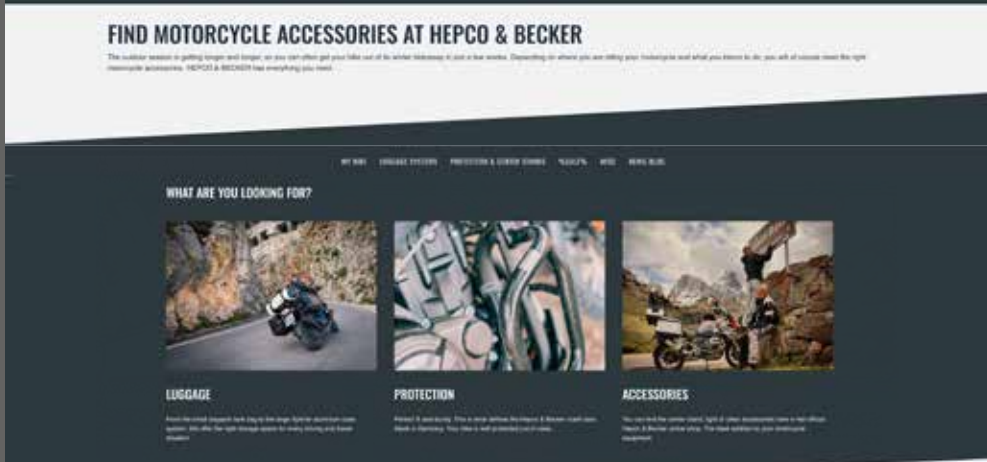

# ONLINE

## Our english website

Provides comprehensive information:

- The latest product development - Catalog in PDF format
- Assembly instructions - Fast, individual brand search
- All our products for your motorcycle

**Sales Hotline: +49 (0)6331 / 1453-105**

**Openings: Mo.-Fr. 8:00-12:00 a.m. & 12:30-04:00 p.m.**

Years of experience and deep technical knowledge

We offer short delivery terms, fast and uncomplicated customer service and a 5 year warranty for easier business with us.

For further information please contact our importers directly (for more details see our web page) or send an e-mail to us. [sales@hepco-becker.de](mailto:sales@hepco-becker.de)

## Find a dealer/importer in your country

- On our website



**HEPCO & BECKER**



## CONTACT

For further information please contact our importers directly: (for more details see our web page) or send an e-mail to us: [sales@hepco-becker.de](mailto:sales@hepco-becker.de)



Print product with financial  
**climate contribution**  
ClimatePartner.com/53510-2312-1020



**HEPCO & BECKER**