

A person wearing a white helmet and dark riding gear is riding a black motorcycle on a paved road that curves through a lush, green, hilly landscape. In the background, a sandy dune and a blue sky with light clouds are visible. The overall scene is bright and scenic.

# ***DAYTONA***

**2024-2025**

**HIGH PERFORMANCE PARTS AND ACCESSORIES  
FOR ALL THE MOTORCYCLE LOVERS  
SINCE 1972**

# DAYTONA

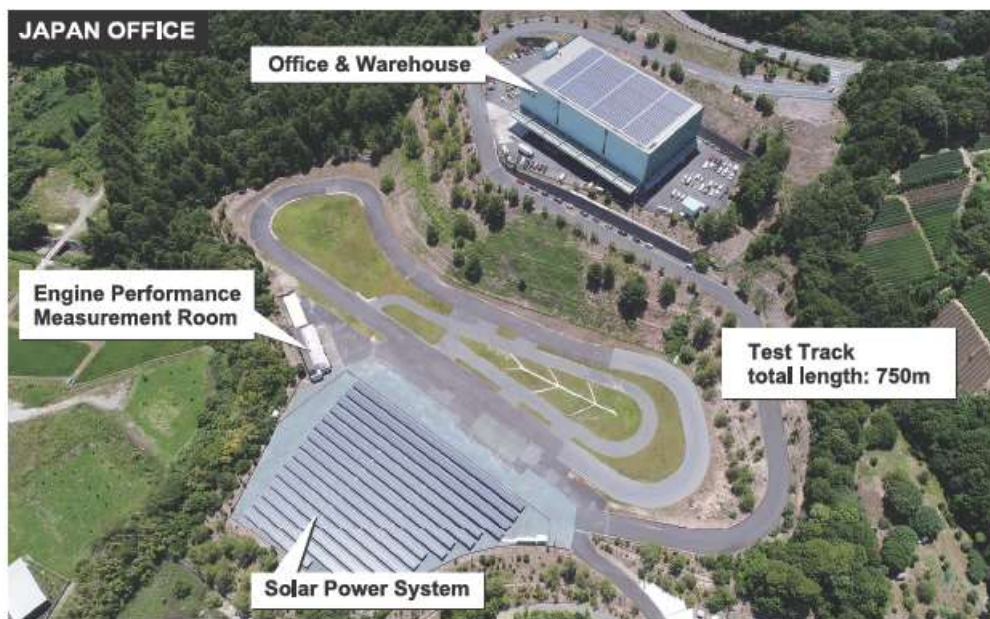

## DAYTONA CORPORATION

4805 Ichimiya, Mori-machi,  
Shuchi-gun, Shizuoka, 437-0226, Japan  
<https://daytona-europe.com>

# Message

**Welcome to Daytona Japan!**

**For over 50 years, we've been passionate about creating high-quality motorcycle parts that riders love. As a top brand in Japan, we take pride in our legacy and commitment to the motorcycle community.**

**At Daytona Japan, we believe in enhancing every ride. Our extensive range of innovative customization parts and cutting-edge accessories is designed to elevate the riding experience for enthusiasts around the world.**

**Whether you're seeking performance, style, or reliability, our products are crafted to meet the diverse needs of every motorcycle and rider.**

**With a strong global presence, we're proud to serve customers from all corners of the world. Our mission is simple: to ensure that every rider can enjoy the thrill of the open road with confidence and excitement, powered by our reliable and exhilarating motorcycle parts.**



**Join us on this exciting journey  
and experience the Daytona Japan  
difference.**

**Happy riding!**

**President  
Tetsu, Oda**

# Handlebar Control Switch

**NEW**

■3-Button Control switch



#81254 Chrome button



#81371 Black chrome button

- Housing: CNC aluminum
- Button: Coated ABS
- For 22.2/25.4mm handlebars
- Max. current 50mA
- No need to drill hole on handlebar
- Need relay to function
- Incl. icon stickers

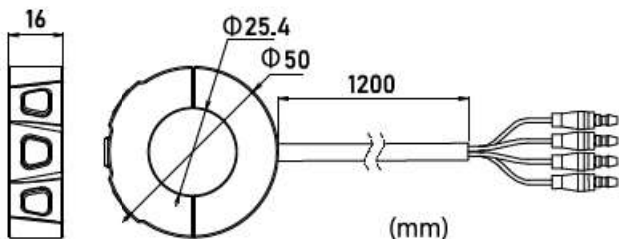



#### Key Features

- Compatible with both 6V & 12V systems (Operating voltage: 6–18V DC)
- Built-in turn signal relay for easy wiring
- Compact design: 75x30x20mm, made from durable ABS material
- Auto-cancel function for turn signals
- Supports up to 8 switch connections for a fully customizable setup
- Works with Daytona handlebar switches and common momentary-type switches
- Reverse current protection to prevent damage
- Waterproof (IP67) for reliable performance in all weather conditions
- CE approved

#### Input:

- ACC IN (Max 20A), GND IN

#### Outputs:

- Left and right turn signals (L OUT, R OUT), max. 5A each
- Headlight (HI OUT, LOW OUT), max. 10A each
- Horn (HORN OUT), max. 10A
- Starter relay (START OUT), max. 15A
- Accessories (ACC OUT), max. 10A
- Optional output 1 (OPT1 OUT – e.g., fog lights), max. 10A
- Optional output 2 (OPT2 OUT – for pass switch), max. 10A
- Optional output 3 (OPT3 OUT – for kill switch), max. 15A



#81255

# VELONA60-WP



**NEW**



#81443

- SPEED & RPM
- 200km/h (MPH)
- 0-20,000rpm
- 0-99,999.9km (mile)
- 1 & 2, 0-9,999km (mile)
- DC 10.0-16.0V
- Indicators

- Aluminum housing
- Incl. V-shaped bracket

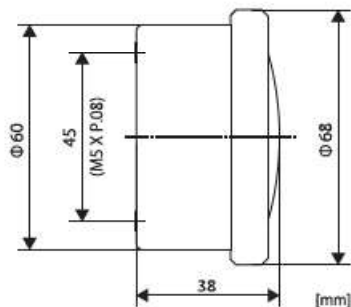

*New white panel!*



# VELONA-W

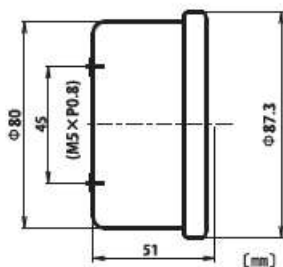

#89364

- Two Needles (SPEED & RPM)
- 200km/h (MPH)
- 0-9,000rpm
- 0-99,999.9km (mile)
- 1 & 2, 0-99,999.9km (mile)
- DC 10.0-16.0V
- Memory & Recall
- Memory & Recall
- Indicators
- Indicators
- Indicators
- Indicators

- Stainless-steel housing
- Incl. V-shaped bracket



Photo by : JSL MOTO

# VELONA80



Photo by : Schepers Motoren Design



#87789  
[140]



#87790  
[200]



#87791  
[260]



140/200/260 km/h (MPH)



0-20,000rpm



0-99,999,9km (mile)



1 & 2, 0-99,999,9km (mile)



DC 10,0-18,0V



Memory & Recall



with Red LED lamp



Indicators



0-399km/h (0-260MPH)



9000rpm / 15000rpm



0-99,999km/h(mile)



1 & 2, 0-99,999,9km (mile)



DC 10,0-18,0V



Memory & Recall



with Red LED lamp



Indicators

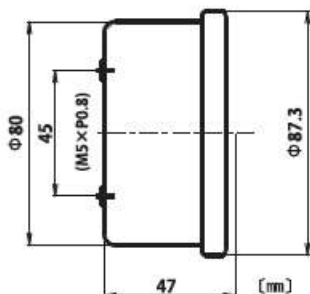

- Stainless-steel housing
- Incl. V-shaped bracket



#87792  
[9000]



#87793  
[15000]



# VELONA60



Photo by sJM Customs

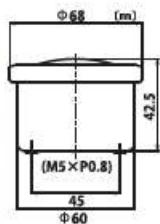

## ■ SPEED (km/h or MPH)



#88641  
[140]



#88642  
[200]



#88643  
[260]



#86267  
[260]



## ■ RPM



#88644  
[9000]



#88645  
[15000]



#88677  
[15000]



#87527  
[15000]



# Digital VELONA



#85836

-  SPEED & RPM
-  0-399km/h (0-250MPH)
-  0-20,000rpm
-  0-99,999km(mile)
-  1 & 2, 0-9,999.9km(mile)
-  RPM bar-scale programmable

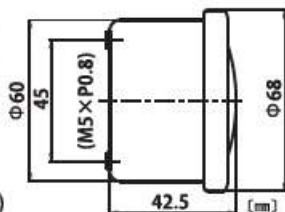

- Stainless-steel housing
- Incl. V-shaped bracket



# VELONA-Volt

When less than 12V



#80859

#80860

-  8,0-16,0V
-  Low voltage alert by Red LED backlight when less than 12V
- Stainless - steel housing
- Incl. V-shaped bracket

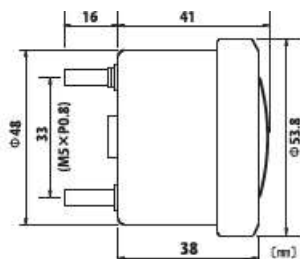

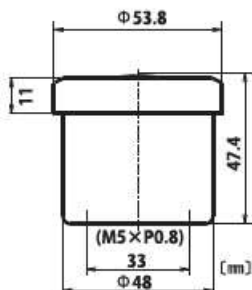

# VELONA48



- Stainless-steel housing
- Incl. V-shaped bracket

## ■ SPEED (km/h or MPH)



-  200/260 km/h (MPH)
-  0-99,999.9km (mile)
-  1 & 2, 0-99,999.9km (mile)
-  DC 10.0-18.0V
-  Memory & Recall
-  Changeable backlit  
White / Blue / Orange

## ■ RPM



-  9000rpm
-  DC 10.0-18.0V
-  Memory & Recall
-  with Red LED lamp
- Changeable backlit  
White / Blue / Orange

## ■ Mount Kit for VELONA48 RPM



#81322  
for HONDA CMX500 (2017-2023)







#81324  
for HONDA CL500 (2023)

**NEW**



# Digital Gauge CUBE



-  0-399km/h or 0-250MPH
-  0-10,000 or 20,000rpm
-  0-99,999km (mile)
-  1 & 2, 0-9,999.9km (mile)
-  DC 8.0-18.0V
-  RPM bar-scale  
10,000 / 20,000rpm
-  Bar-graph blinking

- Aluminum housing, black anodized
- Compact size

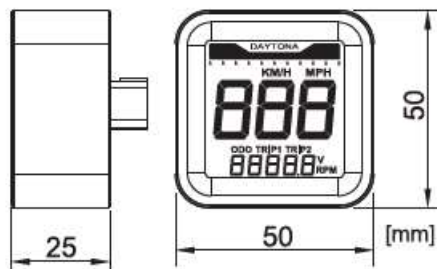

# Multifunction Cockpit









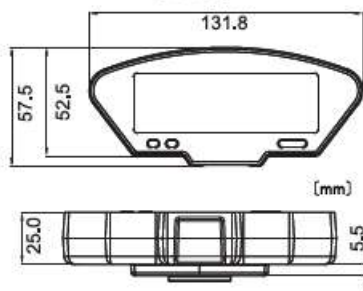















■DEVA  



#89363



- ABS housing
- Incl. stainless-steel bracket
- Incl. magnetic speed sensor

- |  |   |
|--|---|
|  0-399km/h or<br>0-250MPH   |  0-10,000 or<br>20,000rpm          |
|  0-99,999.9km (mile)  |  RPM bar-scale<br>10,000/20,000rpm |
|  1&2, 0-9999.9km (mile)   |  Memory & Recall                   |
|  0-99,999.9km (mile)<br>Set start from any value  |  Bar-graph blinking                |
|  Memory & Recall  |  Fuel Gauge<br>(100Ω,250Ω,510Ω)    |
|  8.0-18.0V  |  0°C ~ +150°C<br>(+32°F ~ +356°F)  |
|  Low Battery Warning  |  0°C ~ +150°C<br>(+32°F ~ +356°F)  |
|  12h or 24h   |  -10°C ~ +60°C<br>(+14°F ~ +140°F) |
|  N, 1, 2, 3, 4, 5, 6 Top 4/5/6 selectable   |   |
|       Indicators |   |

Option



#89845  
Handle clamp kit



#89846  
Oil temp sensor



#89847  
Air temp sensor







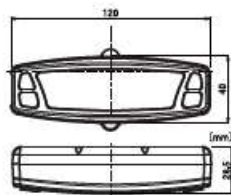









■ASURA 



#84787



- ABS housing
- Incl. clamp for Φ22,2/25,4/31,8mm handlebars
- Incl. magnetic speed sensor

- |  |  |
|--|--|
|  0-399km/h or<br>0-250MPH  |  0-20,000rpm                         |
|  0-99,999.9km (mile)  |  1&2, 0-999.9km (mile)              |
|  -10°C ~ +60°C<br>(+14°F ~ +140°F)  |  40°C ~ +200°C<br>(+104°F ~ +392°F) |
|  Memory & Recall  |  Memory & Recall                    |
|  12h or 24h   |  Fuel Gauge                         |
|  Low Battery Warning  |  Oil Changing Time Notification     |
|     Indicators |  |

Option



#84851  
Temp Sensor

# NANO I

- 40(W)x60(L)x17.6(D)mm
- Without backlight
- Coin cell driven (CR2032)
- Unit detachable

## ■TEMP



#85995

- 0°C ~ +270°C (+32°F ~ +518°F) 12h
- 0°C ~ +60°C (+32°F ~ +140°F) Memory & Recall
- Low Battery Warning

※ Incl. R1/8 sensor

## ■RPM



#86719

- 0-20,000rpm
- Resettable & Non-resettable, 0-9,999.9hours
- 12h
- Memory & Recall

# NANO II

- 40(W)x60(L)x22(D)mm
- White LED backlight
- Work on DC12V
- Clamp for Φ22.2/25.4mm handlebars

## ■SPEED



#86596

- 0-399km/h or 0-250MPH
  - 0-999,999km (mile)
  - 1 & 2, 0-99,999.9km(mile)
  - 12h Memory & Recall
- ※ Incl. magnetic speed sensor

## ■GEAR



#86533

- N, 1, 2, 3, 4, 5, 6, 7, 8  
Top 4/5/6/7/8 selectable
- Bar-graph blinking

# Compact Gauge Series

## ■ Volt Meter



#89279



7.5 ~ 18.0V



Low voltage alert  
by Red LED backlight  
when less than 12V

- 25(W) x 42(L) x 10.8(D)mm
- White LED backlight
- Waterproof (IPX7)

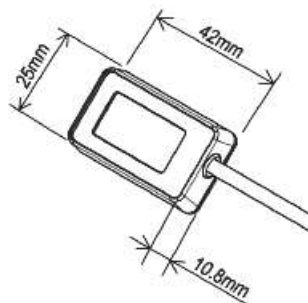

## ■ Wireless Hour Meter



#80072



0-999,999 hours 59minutes

- 36(W) x 57(L) x 17.3(D)mm
- No wiring connection required
- The battery included inside cannot be replaced
- Battery life approx. 4years
- Waterproof (IP68)

# Gauge Options

## ■ Proximity Speed Sensor



"Non-contact" type speed sensor,  
can generate electrical pulse signal from most vehicles.

Wire length : 2000mm

Max.current : 100mA

#87038

## ■ Speed Pulse Converters



Dia10 insert

TRIUMPH, HONDA,  
BMW etc.

Wire length : 1280mm

#87755



Dia18 plug connection

YAMAHA SR400/500  
etc.

Wire length : 1280mm

#87041



Dia15 insert

HONDA, SUZUKI etc.

Wire length : 1800mm

#87143



M12 thread female

YAMAHA, SUZUKI,  
DUCATI, MOTO GUZZI  
etc.

Wire length : 1200mm

#87429



For BMW

BMW boxer models  
Wire length : 700mm

#88457



Universal

Wire length : 650mm



OEM  
SPEEDOMETER CABLE

#87430

## ■ RPM Induction Wire Set



For easy detection of  
RPM pulse connecting to  
spark plug wire or  
to ignition coil

#87170

## ■ RPM Pulse Rectifier



For cases  
that RPM pulse cannot  
be detected well or  
RPM signal is unstable

#92333

## ■ Temp Sensor (R1/8)

Wire length : 1000mm



#80228



## ■ Remote Control Switch



Operates VELONA gauges remotely instead of pressing bottom buttons.

- For  $\Phi 22.2/25.4$ mm handlebars
- Wiring outside or inside handlebar possible
- Max. current capacity 50mA
- Width 12mm



Round type  
#80918 BLACK  
#80919 CHROME

Edge type  
#87047 BLACK



## ■ Adjustable Bracket of VELONA-W, VELONA80, VELONA60



#80203



- mount pitch adjustable 63-112mm

## ■ Combinative Brackets for VELONA48



#87768



#87785



## ■ Anti-vibration Brackets for VELONA60



#61197

#63526



#63527

#63528

## ■ Combinative Brackets for VELONA60



#87404



#87403



#63529

# LED Micro Indicator

■GAMMA



#81068

- Aluminum body
- CNC Aluminum clamp for  $\Phi 22,2/25,4$ mm handlebars
- Vertical & horizontal installation possible

3 Interchangeable lenses!



■ALPHA



#86531 BLACK

#86532 CHROME

- ABS body
- Aluminum clamp for  $\Phi 22,2/25,4$ mm handlebars
- Vertical & horizontal installation possible

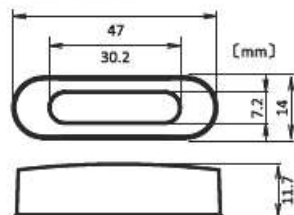

# D-Mirror-3



■ Aluminum Housing & Stem



#89428  
Bar-end type  
1PC



#89429  
Standard type  
1PC

# D-Mirror-4



■ Aluminum Housing & Stem



#89430  
Bar-end type  
1PC



#89431  
Standard type  
1PC

# D-Mirror-5



## ■Aluminum Housing & Stem



#89474  
Bar-end type  
1PC



#89475  
Standard type  
1PC

# D-Mirror-6



## ■Aluminum Housing & Stem



#89722  
Bar-end type (Short)  
1PC



#89723  
Bar-end type (Long)  
1PC

## ■Aluminum housing & steel stem



#89724  
Standard type (Right)  
1PC



#89725  
Standard type (Left)  
1PC

# D-Mirror-7



## ■Aluminum Housing & Stem



#89726  
Bar-end type (Short)  
1PC



#89727  
Bar-end type (Long)  
1PC

## ■Aluminum housing & steel stem



#89728  
Standard type (Right)  
1PC



#89729  
Standard type (Left)  
1PC

# D-Mirror-8



## ■Aluminum Housing & Stem



#89730  
Bar-end type (Short)  
1PC



#89731  
Bar-end type (Long)  
1PC

## ■Aluminum housing & steel stem



#89732  
Standard type (Right)  
1PC



#89733  
Standard type (Left)  
1PC

# D-Mirror-9



■ABS housing & aluminum stem



■ABS housing & steel stem



#89813  
Bar-end type (Short)  
2PCS/SET



#89814  
Bar-end type (Long)  
2PCS/SET



#89815  
Standard type  
L/R SET

# D-Mirror-10



■ABS housing & aluminum stem



■ABS housing & steel stem



#89816  
Bar-end type (Short)  
2PCS/SET



#89817  
Bar-end type (Long)  
2PCS/SET



#89818  
Standard type  
L/R SET

# D-Mirror-11



■ABS housing & aluminum stem



#80715 LEFT (cowl type)  
#80716 RIGHT (cowl type)



#80719 LEFT  
#80720 RIGHT

# D-Mirror-12



■ABS housing & aluminum stem



#80717 LEFT (cowl type)  
#80718 RIGHT (cowl type)



#80721 LEFT  
#80722 RIGHT

# D-Mirror-13



■ABS housing & aluminum stem

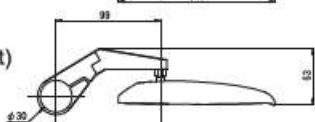
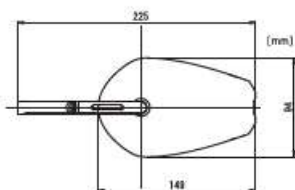

#80761  
Bar-end type (Short)  
1PC

# D-Mirror-14



■ABS housing & aluminum stem

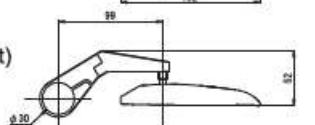
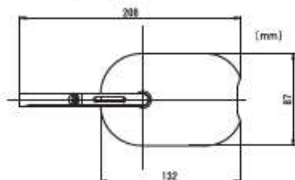

#80762  
Bar-end type (Short)  
1PC



# D-Mirror-15



■Aluminum Housing & Stem



#80799 Bar-end type  
1PC



*Very flat housing!*  
4 ~ 6mm

# D-Mirror-16



■Aluminum Housing & Stem



#80800 Bar-end type  
1PC



# D-Mirror-17



■Aluminum Housing & Stem



#80801 Bar-end type  
1PC



# D-Mirror-18

■ABS housing & Nylon stem



*Easily install  
anywhere on the handlebar  
without removing parts!*



#80917  
Handlebar clamp type  
1PC

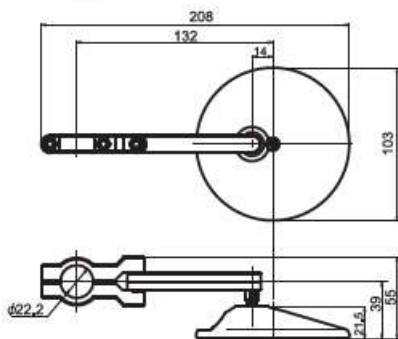

# D-Mirror-19

■ABS housing & Nylon stem

*Ideal shape  
for under the handlebar position,  
hard to hit the tank  
when turning the handlebar*



#81001  
Handlebar clamp type  
1PC

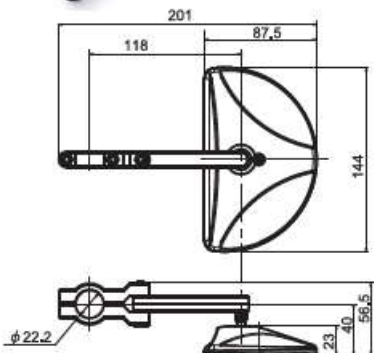

# D-Mirror-20

■Aluminum housing & stem



- #80993 Left, 1PC
- #80994 Right, 1PC

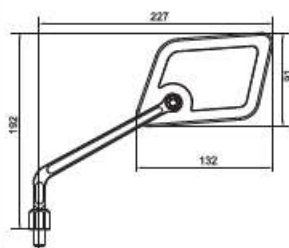

# D-Mirror-21

■Aluminum housing & stem



- #80998 Left, 1PC
- #80999 Right, 1PC

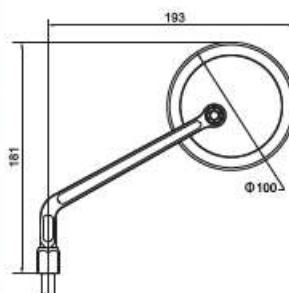

# D-Mirror-22

■Aluminum housing & stem



#81073  
Bar-end type  
1PC

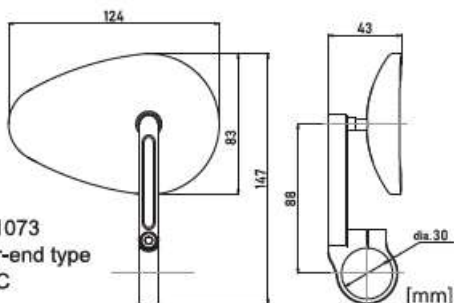

# D-Mirror-23

■Aluminum housing & stem



#81074  
Bar-end type  
1PC

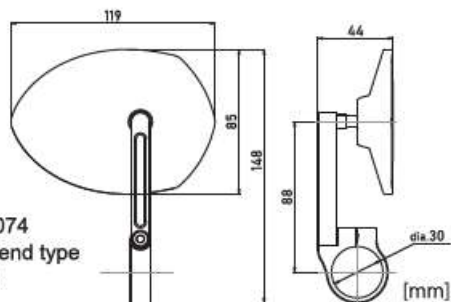

# Mirror Adapters



- CNC Aluminum
- Mount area  $\Phi 30 \times 12 \text{mm}$
- 2pcs/set

## ■ KAWASAKI



#89444

## ■ SUZUKI



#89443

## ■ YAMAHA-1



#89441

## ■ YAMAHA-2



#89442

## ■ BMW



#80863

## ■ UNIVERSAL for 22.2mm

\*Please use adapter A for inner diameters between 13.5 ~ 16 mm and B for 16 ~ 19mm.



#89440

## ■ UNIVERSAL for inner diameters between 19 ~ 22.5mm



#80996

## ■ Adapter for HD

- UNF 5/16-24
- Steel
- 1pc



#87303

# Mirror Hole Plug Bolt



- CNC Aluminum
- 1pc

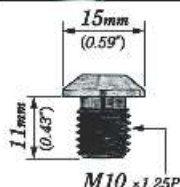

SIZE	RHS	LHS
RED	#99794	#99795
BLUE	#99796	#99797
GOLD	#99798	#99799
GREEN	#99800	#99801
SILVER	#99614	#99615
BLACK	#99616	#99617
TITANIUM	#99618	#99619



SIZE	RHS	LHS
BLACK	#80939	#80943
GUNMETAL	#80940	#80944
RED	#80941	#80945
ORANGE	#80942	#80946

# LED Indicator

## ■D-Light MINI 1

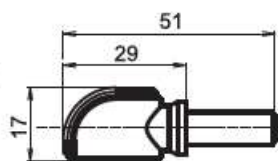

#80758

- Zinc alloy body
- M8 bolt installation
- ECE approved for front and rear



## ■D-Light MINI 2

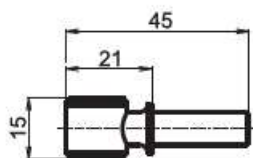

#80825

- Zinc alloy body
- M8 bolt installation
- ECE approved for front and rear



## ■D-Light MINI 3

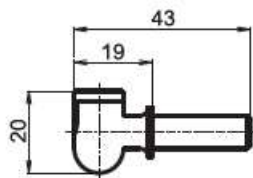

#80826

- Zinc alloy body
- M8 bolt installation
- ECE approved for front and rear



## ■D-Light SOL 2



**NEW**



#81247 ORANGE LENS



#81248 SMOKE LENS

- CNC Aluminum body
- M8 bolt installation
- ECE approved for front and rear

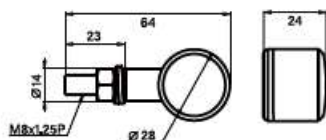

## ■D-Light STELLAR



#88266

- Aluminum body
- M8 bolt installation
- ECE approved for front and rear
- Sequential lighting

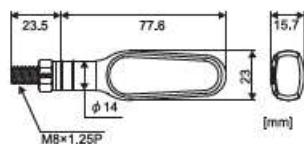

## ■D-Light RAY



#89273

- Aluminum body
- M8 bolt installation
- ECE approved for front and rear
- Sequential lighting

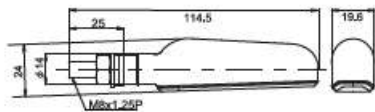

■D-Light CLASSIC 



#81043

- Aluminum body
- M8 bolt installation
- ECE approved for front and rear

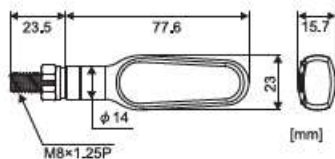

■D-Light SOL 



#88703  
ORANGE LENS



#88731  
SMOKE LENS

- Aluminum body
- M8 bolt installation
- ECE approved for front and rear

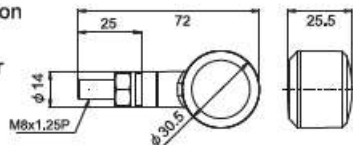

■D-Light SOL-W  



#89275  
SMOKE LENS

- Aluminum body
- M8 bolt installation
- ECE approved for rear indicator and stop & tail
- 3 in 1

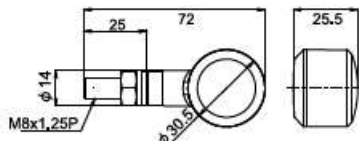



# IC Relay

## ■10P for HONDA, hazard & position & ESS

**NEW**



#81442

- Power : DC8-16V (regular 12V)
- Power range : 0.1~100W
- Direction flashes : 85 count/minutes
- Hazard flashes : 85 count/minutes
- ESS flashes : 220 count/minutes
- Position light canceller
- CE approved

For CB650R/CBR650R(2024), CB125R (2024),  
CBR500R(2024), NX500 (2024),  
Hornet 500[CB500HORNET] (2024) etc..

## ■HONDA 8P, hazard & position & ESS



#89658

- Power : DC8-16V (regular 12V)
- Power range : 0.1~100W
- Direction flashes : 85 count/minutes
- Hazard flashes : 85 count/minutes
- ESS flashes : 220 count/minutes
- CE approved

For CB500F(2019-2023), CB650R(2019-2022),  
CBR650R(2019-2023), CB1000R(2018-2020),  
CMX250/300/500 REBEL(2020-2022),  
CMX1100 REBEL(2021-2022) etc.,

## ■Universal



#88985

- Power : DC8-16V (regular 12V)
- Power range : 0.1 ~ 100W
- Size : 38×28,4×17,5mm
- Flashes : 85 count/minutes
- Incl. convertible connector (2P→3P)
- CE approved

## ■Universal, hazard & position



#89460

- Power : DC8-16V (regular 12V)
- Power range : 0.1~100W
- Size : 38×28,4×17,5mm
- Flashes : 85 count/minutes
- CE approved

# Options for Direction Indicator

## ■ Fork Clamp for Indicator Mount



- CNC aluminum
- For M8 indicator
- Inside groove for discreet wiring

#89855	Φ35mm
#89856	Φ39mm
#89857	Φ41mm
#89858	Φ43mm
#89859	Φ47mm
#89860	Φ48mm
#89861	Φ49mm
#89862	Φ53mm
#89863	Φ57mm
#89864	Φ59mm



## ■ Extension



#81045



- CNC aluminum
- For M8 indicator (M8 in → M8 out)
- Outer diameter 13mm
- Length 30mm
- Sold by set (2pcs)

## ■ Mounting Plates



#81065 BMW



#97235 KAWASAKI



#97238 HONDA



#97398 SUZUKI



#97420 YAMAHA, KAWASAKI



#86963 SUZUKI



#86964 SUZUKI



#86965 KAWASAKI



#86987 HONDA



#86988 YAMAHA



#86989 YAMAHA



## ■ Adapter Collar M10

#86994

# Headlight

## ■CAPSULE120



- LED headlight
- Steel housing
- Dia. 120mm lens
- Front Position Lamp (ring)

### SIDE-MOUNT

- #88633 BLACK
- #88634 CHROME

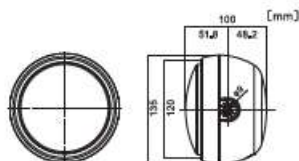

### BOTTOM-MOUNT

- #88635 BLACK
- #88636 CHROME

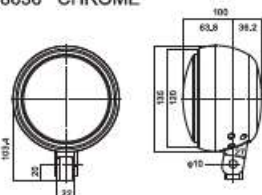

## ■NEO VINTAGE



- LED headlight
- Steel housing
- 5-3/4" (146mm) lens
- Daytime Running Light (center-bar)
- Front Position Lamp (ring)
- With a hole for  $\Phi 60$ mm gauge installation

- #88431 BLACK
- #88432 CHROME

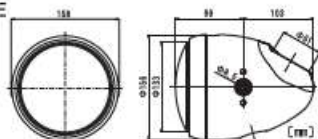

## ■VINTAGE



- Steel housing
- 5-3/4" (146mm) lens
- H4 12V 60/55W bulb with T10 5W position light
- With a hole for  $\Phi 60$ mm gauge installation

- #86903
- RHS, BLACK

- #86904
- RHS, CHROME

- #87357
- RHS, BLACK & BLACK



# Headlight Brackets

## ■Dual-axis Adjustable Type



- #80725 for  $\Phi 35\text{mm}$
- #80726 for  $\Phi 39\text{mm}$
- #80727 for  $\Phi 41\text{mm}$
- #80728 for  $\Phi 49\text{mm}$

● Material : CNC aluminum



● The fork clamp can be adjusted vertically, allowing the headlight position to be adjusted in the front-back direction.

● M8 indicator mount kit is included



## ■Modern Type

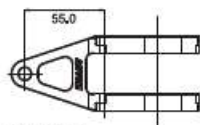

SHORT

- #88622 for  $\Phi 35\text{mm}$
- #88623 for  $\Phi 39\text{mm}$
- #88624 for  $\Phi 41\text{mm}$
- #88625 for  $\Phi 43\text{mm}$
- #88626 for  $\Phi 49\text{mm}$

● Material : CNC aluminum

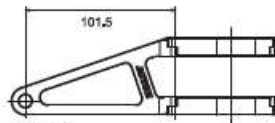

LONG

- #88617 for  $\Phi 35\text{mm}$
- #88618 for  $\Phi 39\text{mm}$
- #88619 for  $\Phi 41\text{mm}$
- #88620 for  $\Phi 43\text{mm}$
- #88621 for  $\Phi 49\text{mm}$



#88624



#88619

# LED Taillight

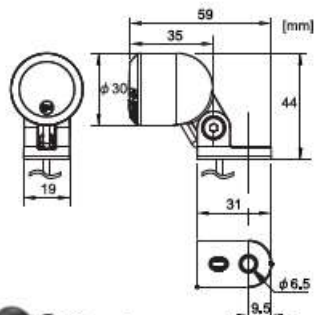

#80930

- Housing & bracket material : zinc alloy
- Fixing hardware material : stainless-steel
- ECE approved for stop & tail light
- M6 bolt installation
- Mounting angle adjustable

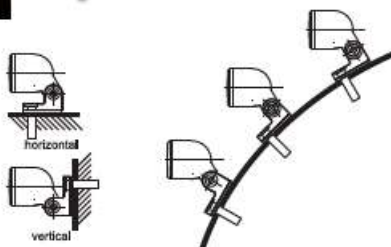

# LED License Plate Lamp

- ECE approved

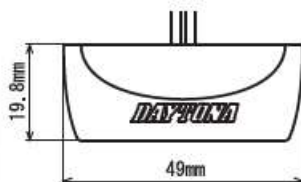

#88857

# Slim Reflector

- Reflector area 100 x 13mm



#87192 Bolt-on

#87193 Tape-down

# Universal ON / OFF Switch

## ■ Slim Type

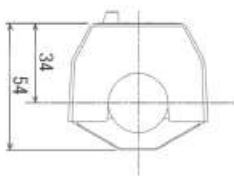
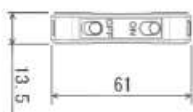

- Max. current 15A (12V-180W, 6V-90W)
- For  $\Phi 22.2/25.4$ mm handlebars
- Housing material: nylon
- Wire length: 800mm



#88159 Flat Seesaw Type



#88160 Toggle Type

## ■ For H4 Headlight



#88162 Flat Seesaw Type



- Max. current 15A (12V-180W, 6V-90W)
- For  $\Phi 22.2/25.4$ mm handlebars
- Housing material: nylon
- For H4 bulb only
- Wire length: 900mm

## ■ Slide Type



#71779 BLACK



#40440 YELLOW

- Size : 20×35×17mm (12V-180W, 6V-90W)
- 12V/6V
- 100W
- Wire length: 800mm

# Smartphone Holder

## ■SMARTPHONE HOLDER 3



#80218 RIGID TYPE (bolt-mount clamp)  
#80219 DETACHABLE (quick-release clamp)

- Width adjustable 55 ~ 85mm
- Length adjustable 123 ~ 170mm
- Depth for 6 ~ 18mm
- Weight for up to 300g
- Clamp for  $\Phi 22 \sim 29$ mm handlebars

DETACHABLE  
(quick-release clamp)



RIGID TYPE  
(bolt-mount clamp)

## ■SMARTPHONE HOLDER 1



#87963 RIGID TYPE (bolt-mount clamp)  
#87964 DETACHABLE (quick-release clamp)

- Width adjustable 55 ~ 85mm
- Length adjustable 110 ~ 147mm  
※using additional arm : over 153mm possible
- Depth for 6 ~ 18mm
- Weight for up to 300g
- Clamp for  $\Phi 22 \sim 29$ mm handlebars

# USB Power Supply

**NEW**



## TYPE-A

#81354

USB "TYPE-A" × 1port

- ABS housing
- QC3.0 (Quick charge 3.0)
- Input DC12.5V
- Max.30W
- Output 5V/3A, 9V/2A, 12V/1.5A
- For 22.2 & 25.4mm handlebars
- Powers on ignition key
- Over current protection
- Short-circuit protection
- CE approved





**TYPE-A**

#89371

Slim-mount USB "TYPE-A" × 1 port

- Input : DC12V
- Output : DC5V
- Rated current : 2,4A
- Housing : ABS resins
- For 22.2mm/ 25.4mm handlebars
- Powers on with ignition key
- CE approved

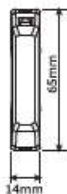
**TYPE-A**

#89372

Slim-mount USB "TYPE-A" × 2 port

- Input : DC12V
- Output : DC5V
- Rated current : 2,4A × 2 port
- Housing : ABS resins
- For 22.2mm/ 25.4mm handlebars
- Powers on with ignition key
- CE approved

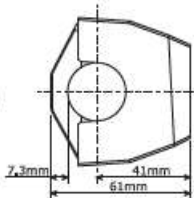
**TYPE-A**

#80729

USB "TYPE-A" × 1 port

- Input : DC12V
- Output : DC5V
- Rated current : 2.4A
- Powers on with ignition key
- CE approved

**TYPE-A**

#80730

USB "TYPE-A" × 2 port

- Input : DC12V
- Output : DC5V
- Rated current : 2.4A × 2 port
- Powers on with ignition key
- CE approved



### TYPE-C



#80399

USB "TYPE-C" × 1port

- For USB PD (Power Delivery)
- Input : DC12V
- Output : 5V/3A, 9V/2A, 12V/1.5A
- Max : 18W
- Powers on with ignition key
- CE approved

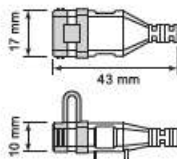

### TYPE-C



#80400

Slim-mount USB "TYPE-C" × 1 port

- For USB PD (Power Delivery)
- Input : DC12V
- Output : 5V/3A, 9V/2A, 12V/1.5A
- Max : 18W
- For 22.2mm/ 25.4mm handlebars
- Powers on with ignition key
- CE approved

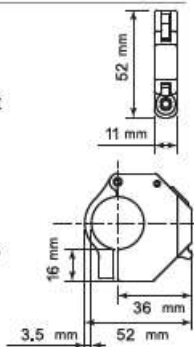

### TYPE-C



#80992

USB "TYPE-C" × 1port

- Aluminum housing & nut
- For USB PD(Power Delivery)
- Input DC12V
- Output 5V/3A, 9V/2A, 12V/1.5A
- Max.18W
- Powers on ignition key
- Green LED indicator when charging
- CE approved

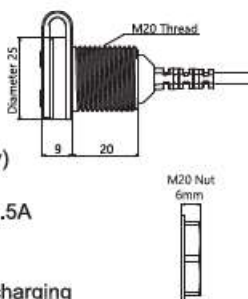

### TYPE-C

#80967

USB "TYPE-C" × 1port

- Aluminum housing
- For USB PD(Power Delivery)
- Input DC12V
- Output 5V/3A, 9V/2A, 12V/1.5A
- Max.18W
- For 22.2/25.4mm handlebars
- Powers on with ignition key
- CE approved

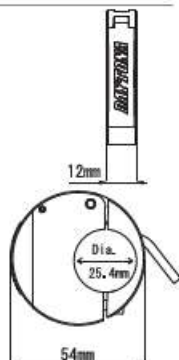

# USB Cable for Motorcycle



- #80468 TYPE-C to TYPE-C
- #80469 TYPE-C to Lightning
- #80470 TYPE-A to TYPE-C
- #80471 TYPE-A to Lightning

- L-shaped
- Wire length : 20cm
- 18W (5V/3A, 9V/2A, 12V/1.5A)
- #80469 & #80471 with MFi approval

# Smartphone DIRECT Charging Cable



- #15644 TYPE-C
- #15645 Lightning

- L-shaped
- Wire length : 800mm (from Connector to connector)
- LED lamp
- Powers on with ignition key
- #15645 with MFi approval

POWER

DAYTONA "DIRECT" charging cable



# Mount Bar Holder

- Creates space for smartphone, navigation, USB power supply or switch etc.
- Bar diameter 22,2mm

## ■Master Cylinder Clamp Type



- #92746 BLACK,100mm  
#77435 BLACK,155mm  
#77434 CHROME,155mm

## ■Master Cylinder Clamp Flat Type



- #92801 BLACK,100mm  
#92802 CHROME,100mm

## ■Handle Clamp Type



- #92748 BLACK,100mm  
#92747 CHROME,100mm  
#77437 BLACK,155mm  
#77436 CHROME,155mm

## ■Mirror Clamp Type



- #78031 BLACK,100mm  
#78030 CHROME,100mm

# Free Combination Handle Brace



Adapter bar : 50mm



Bar : L200mm / L250mm



Clamp (pair)

For	Bar		Clamp Φ22,2mm	Adapter bar 50mm
	200mm	250mm		
RED	#99427	#99433	#99440	#99469
BLUE	#99428	#99434	#99441	#99470
GOLD	#99429	#99435	#99442	#99471
GREEN	#99430	#99436	#99443	#99472
SILVER	#99431	#99437	#99444	#99473
BLACK	#99432	#99438	#99445	#99474

# Handlebar Bracket



#97253 BLACK

#98516 SILVER

#77791

- Aluminum handle clamp bracket
- For  $\Phi 22.2$ mm handlebar
- Plate 40 x 40mm
- Angle adjustable

- ABS handle clamp bracket
- For  $\Phi 22.2/25.4$ mm handlebars
- Plate 34 x 35mm

## ■ Type B

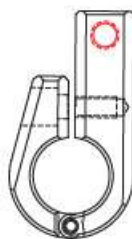

- #68453 : M8, 7/8" (22.2mm)
- #68459 : M8, 1" (25.4mm)
- #68456 : M10, 7/8" (22.2mm)
- #68462 : M10, 1" (25.4mm)

## ■ Type C

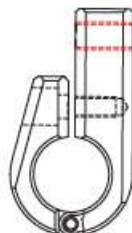

- #68454 : M8, 7/8" (22.2mm)
- #68460 : M8, 1" (25.4mm)
- #68457 : M10, 7/8" (22.2mm)
- #68463 : M10, 1" (25.4mm)

# Heated Grips

■ **Built-in Switch, 4-level Heat Control**

#88640



4-level Heat Control  
For  $\Phi 22.2\text{mm}$  (7/8") motorcycles  
Open end



#89820



4-level Heat Control  
For  $\Phi 22.2\text{mm}$  (7/8") motorcycles  
Open end



★ **Battery Protection**

※ automatically turned off  
when voltage is less than 12V



#81044

4-level Heat Control  
For  $\Phi 22.2\text{mm}$  (7/8") motorcycles  
Open end



### ■ Built-in Switch, 3-level Heat Control



#87407

For  $\Phi 22.2\text{mm}$  ( 7/8" ), Open end



#88019

For  $\Phi 25.4\text{mm}$  ( 1" )  
Closed end

#88020

For Harley Davidson  
(96UP, 08UP)  
Closed end



### ■ 4-level Heat Control



#88987

For  $\Phi 22.2\text{mm}$  ( 7/8" ), Open end

#88988

For ATVs, Open end



#86610

For  $\Phi 25.4\text{mm}$  ( 1" ), Closed end



### ■ Spare Switch



#86983

orange button



#89650

black button w/clamp kit

### ■ Thumb warmer



#89875

For ATV Heated Grips (#88988)

### ■2-level Heat Control



#86607

For  $\Phi 22.2\text{mm}$  ( 7/8" )  
Closed end

### ■Spare Switch



#24050

### ■Glue

**NEW**



#81282

Glue for heated grips, GORILLA

- Heatproof temperature 93°C
- 3g/pc for left & right grips

## Grip Warmer



#80583

- 12V
- Size : 105×95mm
- ON/OFF switch
- Wrap type

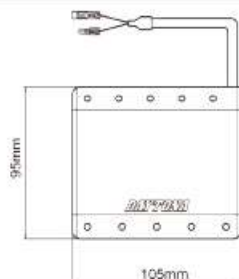



# GrippyGrip

## ■GGD-CLASSIC (Φ22.2mm/L122mm)



#33448  
BLACK



#33513 BROWN #33520 RUBBER-LIKE

## ■GGD-VINTAGE (Φ22.2mm/L122mm)



#33445  
BLACK



#33446 BROWN #33447 RUBBER-LIKE

## ■GGD-KNIT (Φ22.2mm/L122mm)



#33432  
BLACK



#33440 BROWN #33444 DARK RED

## ■GGD-GRID (Φ22.2mm/L122mm)



#32727  
BLACK



#32728 BROWN #32729 DARK RED #32731 RUBBER-LIKE

## ■GGD-BASE (Φ22.2mm/L125mm)



#88217  
BLACK



#88218 GRAY #88219 BROWN

## ■GGD-DELTA (Φ22.2mm/L123mm)



#88565  
BLACK



#88567 DARK RED

■GGD-NAMI (Φ22.2mm/L125mm)



#88561  
BLACK



#88562  
BROWN

#88563  
DARK RED

■GGD-KANI (Φ22.2mm/L125mm)



#88937  
BLACK



#88938  
GRAY

#88939  
BROWN

#88940  
CARAMEL

■GGD-AMI (Φ22.2mm/L125mm)



#88569  
BLACK



#88613  
GRAY

#88570  
BROWN

#88614  
DARK BLUE

#88615  
DARK GREEN

#88571  
DARK RED

■GGD-SAKURA (Φ22.2mm/L125mm)



#88942  
BLACK



#88943  
GRAY

#88944  
CARAMEL

■GGD-NINJA (Φ22.2mm/L125mm)



#88663  
BLACK



#88664  
GRAY

#88665  
BROWN

#88666  
DARK RED

■GGD-LINE (Φ22.2mm/L125mm)



#88658  
RED



#88659  
BLUE

#88660  
GREEN

#88661  
YELLOW

#88769  
GRAY

■GGD-KATANA (Φ22.2mm/L125mm)



#88573  
RED



#88574  
BLUE

#88575  
GREEN

#88579  
WHITE

#88576  
GRAY

■GGD-CELL (Φ22.2mm/L125mm)



#88669  
RED



#88670  
BLUE

#88671  
GREEN

#88673  
DARK GREEN

#88672  
GRAY

■GGDM-BASE (Φ22.2mm/L125mm)



#80912  
BLACK × SILVER



#80913  
BROWN × SILVER

■GGDM-CROSS (Φ22.2mm/L125mm)



#80914  
BLACK × BLACK



#80915  
BLACK × SILVER

■GGDI-BASE (Φ25.4mm/L125mm)



#89746  
BLACK



#48044  
BROWN

**NEW**  
Color

■GGDI-KAWA (Φ25.4mm/L125mm)



#89747  
BLACK



#48046  
BROWN

**NEW**  
Color

■GGDI-GRID (Φ25.4mm/L127mm)

**NEW**



#47826  
BLACK



#47893 BROWN #47897 OXBLOOD RED

■GGDI-KNIT (Φ25.4mm/L127mm)

**NEW**



#47825  
BLACK



#47901 BROWN #47903 OXBLOOD RED

■GGDI-ARC1 (Φ25.4mm/L125mm)



#88667

■GGDI-ARC3 (Φ25.4mm/L125mm)



#88675

■GGDI-OCTA (Φ25.4mm/L125mm)



#88674

■Grip Spacer



Before

fills the gap ↓



After

#80561

- Material : Neoprene
- O.D. : 50mm
- I.D. : 22 or 26mm
- Thickness : 5mm
- 2pcs/set

# Throttle Sleeve

**NEW**



#77240 HONDA-0



#29453 HONDA-1



#29778 HONDA-2

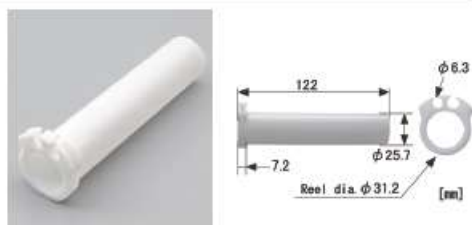

#70673 YAMAHA-0



#29456 YAMAHA-1



#29733 YAMAHA-2



#70360 SUZUKI-0



#29470 KAWASAKI-1



#29479 KAWASAKI-2



#42577 Universal

# Master Cylinder Tank Cap



■ For BMW



#80834



#80836



#80838



#80835



#80837



#80839



#80840

#80834 R1250GS, R1200GS

#80836 R1250GS, R1200GS

#80838 R1250GS, R1200GS

#80835 R NINE T, F850GS

#80837 R NINE T

#80839 R NINE T

#80840 F850GS

- Double color anodized
- CNC Aluminum
- Use OEM diaphragm
- Patented design

■For KAWASAKI, Z650, Z900 etc.



#80634 GREEN



#80635 BLACK

■For HONDA, MONKEY125



#80814 BLACK

#80815 BLUE

#80816 RED

#80817 GOLD

■For HONDA, GROM, CB650R etc.



#80818 BLACK

■For NISSAN



#80636 GREEN  $\Phi$ 42



#80637 BLACK  $\Phi$ 42

■For NISSAN



SIZE	$\Phi$ 38	$\Phi$ 42	$\Phi$ 59
RED	#92737	#92732	#92727
BLUE	#92738	#92733	#92728
GOLD	#92739	#92734	#92729
GREEN	#92740	#92735	#92730
SILVER	-	#92736	-

# Oil Filler Cap



#80638 GREEN  
M20×P2.5



#80639 BLACK  
M20×P2.5



SIZE	M20× P2.5	M24× P3.0
RED	#98399	-
BLUE	#98400	#98406
GOLD	#98401	#98407
GREEN	#98402	-
SILVER	#98403	#98409
BLACK	#98404	-



# Handlebar End Plug

**NEW**

## ■ "RING"



*Can also be used as a  
bar-end mirror adapter.*



- For I.D. 14-19mm
- Outer Diameter 31
- Double function
- Mirror mounting area  $\Phi 30$

#81228 BLACK  
#81229 CHROME

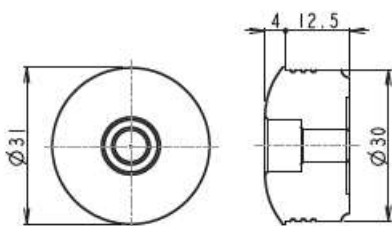

## ■ "W"



- For I.D. 14-19mm
- Outer Diameter 31
- Double function
- Mirror mounting area  $\Phi 30$

#81174 BLACK  
#81175 RED  
#81176 ORANGE

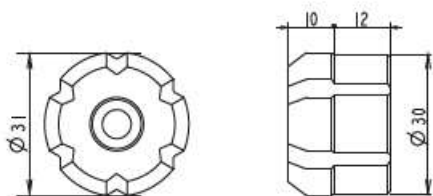

### ■“TKM-2”

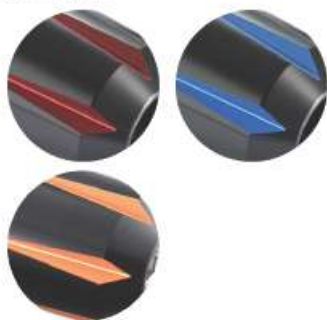

- For I.D. 14-19mm
- Outer Diameter 30mm
- Dual Anodizing

#87331 RED

#87332 BLUE

#88059 ORANGE



### ■“COMPASS”



- For I.D. 14-19mm
- Outer Diameter 30mm

#80897 RED

#80898 BLUE

#80899 SILVER

#80900 ORANGE



### ■“BULLET”



- For I.D. 14-19mm
- Outer Diameter 30mm

#80911 GUNMETAL

#98374 BLACK



### ■“PINO-3”



- For I.D. 14-19mm
- Outer Diameter 30mm

#99981 : RED

#99982 : BLUE

#99983 : CHAMPAGNE

#99984 : GREEN

#99985 : SILVER

#99986 : BLACK



# Crash Pad

**NEW**



- L/R set
- Shock-absorbent PE pad
- Anodized aluminum cap



#81287	YAMAHA	MT07 (2014-), XSR700 (2016-), Tracer700 (2016-2020), R7 (2023-)
#81079	KAWASAKI	Z900 (2017-)
#81345	KAWASAKI	Z650 (2017-), Ninja650 (2017-), Z650RS (2021-)
#81346	HONDA	CMX500 Rebel [S] (2017-), CL500 (2023-)
#81347	HONDA	CB650R (2019-2023)

# Aluminum Meter Visor



**NEW**



Material : Aluminum



#81349



BACKSIDE

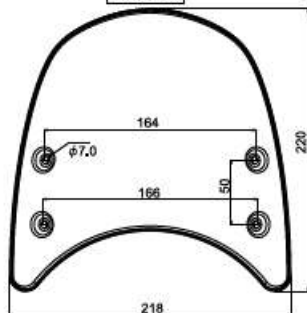

## ■Bracket



#81350  
BMW  
R NINET



#81470  
HONDA  
CB650R(19-23)



#81471  
HONDA  
CMX500(17-19)

**NEW**



#81472  
HONDA  
CMX500(20-23)



#81473  
HONDA  
DAX125(23)  
MONKEY(18-22)



#81474  
YAMAHA  
XSR900(22)



#81439  
YAMAHA  
SR500(78-08)  
SR400FI(10-21)



#81475  
KAWASAKI  
W800(11-16)



#81476  
KAWASAKI  
W650(99-08)



#81477  
KAWASAKI  
Z900RS(18-22)



#81411  
TRIUMPH  
BONNEVILLE



# HenlyBegins Seat Bag

※HenlyBegins is a brand owned by Daytona Japan.



- |                                     |           |                          |                     |
|-------------------------------------|-----------|--------------------------|---------------------|
| ① #96719 (Black) / ⑤ #29783 (Khaki) | 20 ~ 26 ℓ | W(300 ~ 400)×D300×H200mm | Loading Weight 7kg  |
| ② #96720 (Black) / ⑥ #29784 (Khaki) | 33 ~ 42 ℓ | W(490 ~ 610)×D275×H225mm | Loading Weight 8kg  |
| ③ #96721 (Black) / ⑦ #29785 (Khaki) | 44 ~ 60 ℓ | W(410 ~ 570)×D320×H300mm | Loading Weight 10kg |
| ④ #97980 (Black) / ⑧ #29786 (Khaki) | 53 ~ 70 ℓ | W(525 ~ 685)×D320×H300mm | Loading Weight 14kg |

● Polyester ● Incl. rain cover ● Expandable





#19437

**DH-747** 5.5 ℓ

- W220×D295×H165mm
- PC & Polyester
- Incl. rain cover
- Loading weight 5.5kg



#95741 (BLACK)  
#95734 (CARBON × BLACK)  
#95735 (RED)

**DH-708** 4 ℓ

- W250×D285×H110mm
- Artificial leather & Polyester
- Incl. rain cover
- Loading weight 5kg



#97087

**DH-723** 6 ℓ

- W250×D300×H185mm
- Artificial leather & Polyester
- Incl. rain cover
- Loading weight 5kg



#96043

**DH-710** 7 ℓ

- W235×D280×H145mm
- Artificial leather & Nylon
- Incl. rain cover
- Loading weight 5kg



#97241

**DH-722** 7~12 ℓ

- W250×D345×H(150~220)mm
- Polyester • Expandable
- Incl. rain cover
- Incl. shoulder strap
- Loading weight 5kg



#98661

**DH-731** 13~26 ℓ

- W280×D345×H(190~310)mm
- Polyester • Expandable
- Incl. rain cover
- Incl. shoulder strap
- Loading weight 5kg





**NEW**



#48147 (polyester)

#48148 (tarpaulin)

**DH-768 / 769 20 €**

- W440×D300×H170mm
- Incl. rain cover
- Incl. easy ring belt
- Loading weight 5kg



**NEW**



#48385 (BLACK)

#48389 (GRAY)

#48390 (YELLOW)

#41380 (BLACK)

#48383 (GRAY)

#48384 (YELLOW)

**DH-772 40 €**

**DH-767 60 €**

- W530×D300×H270mm
- Loading weight 10kg
- Tarpaulin Fabric
- Incl. shoulder belt and fixing belt
- W550×D330×H350mm
- Loading weight 14kg
- Waterproof

## Backpack



**NEW**



#41379 (BLACK)

#48379 (GRAY)

#48380 (YELLOW)

**DH-766 30 €**

- Ø300×L450mm
- Tarpaulin Fabric
- Loading weight 7kg
- Waterproof
- Incl. shoulder belt and fixing belt



# HenlyBegins Saddle Bag

※HenlyBegins is a brand owned by Daytona Japan.



#40412 LEFT



#40413 RIGHT

11 ℓ W420xD150xH245mm  
Loading Weight 5kg



①



②



③



④



⑤



⑥



⑦



⑧



⑨



⑩

Loading Weight

9 ℓ W360xD130xH200

5kg

①#96906 (DHS-1)

10 ℓ W360xD260xH270

5kg

②#32679 (DHS-29), ③#32680 (DHS-30, DIAMOND)

12 ℓ W420xD150xH245

5kg

④#40262 (DHS-36), ⑤#40263 (DHS-37, DIAMOND)

12 ℓ W360xD10xH270

5kg

⑥#96907 (DHS-2), ⑦#24364 (DHS-21, DIAMOND)

13 ℓ W280xD170xH300

5kg

⑧#18994 (DHS-18)

18 ℓ W400xD150xH300

5kg

⑨#96909 (DHS-4)

22 ℓ W430xD160xH320

5kg

⑩#18996 (DHS-19)

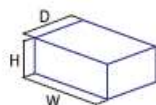

● Artificial leather & Polyester

● Incl. rain cover



#90557 **DHS-13** 10 ℓ W350×D100×H280mm

#99702 **DHS-10** 15 ℓ W365×D135×H320mm

• Polyester



Loading weight 2kg

Loading weight 2kg

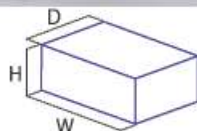

#99703 **DHS-11** 20 ℓ W350×D100×H280mm

#99704 **DHS-12** 30 ℓ W360×D140×H315mm

• Polyester



Loading weight 2kg each

Loading weight 2kg each



10 ℓ W360×D120×H270mm

• Loading weight 2kg

• Polyester



#21774 **DHS-20** BLACK

#30849 **DHS-28** KHAKI

# HenlyBegins Tool Bag

※HenlyBegins is a brand owned by Daytona Japan.



#98771 DHS-7 1.5 ℓ W250×D75×H105mm Loading weight 1.5kg

#98773 DHS-8 2 ℓ W255×D65×H130mm Loading weight 1.5kg

● Polyester

## Under-seat Storage Pocket for Scooters



#93000  
SMALL (250x320)

- For scooters
- Installation with tapping screws
- Storable weight 1kg



#93001  
MEDIUM (270x320)



#93002  
LARGE (270x400)



# Daytona Outdoor

Compact & Light Camping Goods for Riders

## ■MAEHIRO DOME DUO

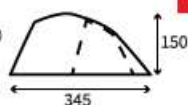
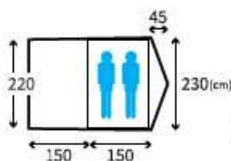

**NEW**



- #42165
- W345×D230×H150cm
  - Inner size 300×220cm
  - Storage size 45×Φ20cm
  - 4,2kg
  - Nylon cover
  - Aluminum pole

## ■MAEHIRO DOME PLUS

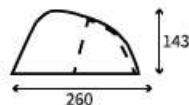
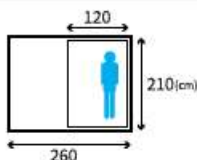

- #48341
- W260×D220×H143cm
  - Inner size 210×120cm
  - Storage size 44×Φ18cm
  - 3.7kg
  - Nylon cover
  - Aluminum pole

## ■MAEHIRO SHELTER

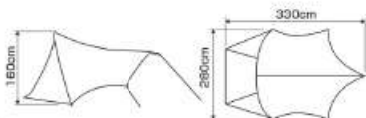

**NEW**

- #44223
- W330×D280×H160cm
  - Storage size 44×Φ10cm
  - 1,35kg
  - Nylon cover
  - Aluminum pole



- Aluminum pole (option)

- #46302
- 100cm



### ■Ground Sheet



#46250

**NEW**

- for tent (#42165)
- 220×150cm
- Storage size 18×21cm
- 300g
- Polyester



#39569

- for tent (#48341)
- 210×120cm
- Storage size 18×21cm
- 240g
- Polyester

### ■Aluminum Forged Peg

**NEW**



#37028

- 200mm
- 53g



#37800

- 300mm
- 75g

### ■Peg Hammer

**NEW**



#48208 BK-STL

- W3×D5×H25cm
- 550g
- Head: Steel
- handle : Beech tree



#48206 BR-SUS

- W3×D5×H25cm
- 550g
- Head: Stainless steel
- handle : Walnut



### ■Chisel

**NEW**



#39610

- W6.5×D1.5×H15cm
- 390g
- Steel



## ■Inflatable Mat



① #35467 (thickness 3.5cm)

② #46247 (thickness 5.0cm) **NEW**

- W183×D53cm
- Storage size (①Φ14.5×27 / ②Φ17×27cm)
- Weight (①680g / ②880g)
- Detachable cushion
- Nylon

## ■Air pillow



#34251

- 42×27cm
- Storage size 11×17cm
- 72g
- Polyester



## ■Barbecue Grill



#16374

- Foldable Design
- W23.7xD17.8xH17.5cm(Unfolded)
- Storage size W23.5×D18×H2.5cm
- 1950g
- Stainless Steel



### ■Foldable Table

**NEW**



#37539

- W40×D34×H36cm
- Storage size W47×D10×H12cm
- 1100g
- Up to 30kg of weight
- Aluminum

### ■Sierra Cup

**NEW**



#48326

- $\Phi$ 12×16.5×4.5cm
- 95g
- Stainless steel



### ■Square Kettle

**NEW**



#37008

- W14.7xD14.7xH5.6cm
- 220g
- Capacity 450ml
- Body: Aluminum / Handle: stainless steel /  
Handle cover: silicon / Lid handle: brass



# Connector & Terminal Set



## TYPE110

- #96167 (2-pole)
- #96168 (3-pole)
- #96169 (4-pole)
- #96170 (6-pole)
- #96171 (9-pole)

#96167



## TYPE250

- #96172 (2-pole)
- #96173 (3-pole)
- #96174 (4-pole)
- #96175 (6-pole)

#96172



## TYPE HM

- #96182 (2-pole)
- #96183 (3-pole)
- #96184 (4-pole)
- #96185 (6-pole)

#96182



## TYPE HM [waterproof]

- #96176 (2-pole)
- #96177 (3-pole)
- #96178 (4-pole)
- #96179 (6-pole)

#96176



## TYPE MT [waterproof]

- #96180 (3-pole)
- #96181 (4-pole)

#96180

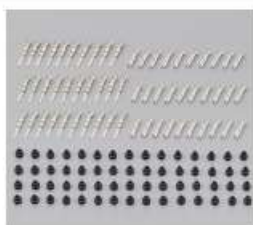

## Terminal Set for HM/MT waterproof connector

- Male terminal x 30
- Female terminal x 30
- Wire seal x 60

#96303



## Bullet Terminal Set

- TYPE CA/CB103
- #96153 Set of 30
- #96155 Set of 5

- TYPE CA/CB104
- #96156 Set of 30
- #96157 Set of 5

- For KAWASAKI
- #96158 Set of 30

#96187



## Bullet Terminal Set [waterproof]

- TYPE CA/CB103
- #41220 Set of 20
- #61938 Set of 5

- TYPE CA/CB104
- #41221 Set of 20
- #61939 Set of 5



## Connector Set TYPE 250 [Reverse Lock]

- #96187 (2-pole)
- #96188 (3-pole)
- #96189 (4-pole)
- #96190 (6-pole)

#96187



## Connector Set for H4 Bulb

- TYPE H4
- male connector x 1
- female connector x 1

- TYPE 305
- male terminal x 3
- female terminal x 3

#96186



## ■Connector Set for Turn Signal



#96191 (2-pole)  
HONDA-A  
LIGHT BLUE



#96192 (2-pole)  
HONDA-A  
ORANGE



#96300 (2-pole)  
HONDA-B  
LIGHT BLUE



#96301 (2-pole)  
HONDA-B  
ORANGE



#96302 (3-pole)  
HONDA-B  
WHITE



#96193 (2-pole)  
SUZUKI  
BLACK



#96194 (2-pole)  
SUZUKI  
GRAY



#96195 (2-pole)  
SUZUKI  
WHITE



#96199 (2-pole)  
KAWASAKI  
BLACK



#96200 (2-pole)  
KAWASAKI  
GRAY



#15414 (2-pole)  
KAWASAKI  
TYPE 040-HX series

## ■Connector Cover Boot



#96206  
Φ8xΦ22x70

#96207  
Φ16xΦ37x84

#96208  
Φ27xΦ42x84

# OEM-colored wire

## ■SQ 0.75 (14A/12V) x 2M

#93181 RED	#93182 BLACK
#93183 GREEN	#93184 LIGHT BLUE
#93185 ORANGE	#93186 BLUE
#93187 WHITE	#93188 YELLOW
#93189 GREEN/ YELLOW	#93190 BROWN
#93191 LIGHT GREEN	#93192 BLACK/ WHITE
#93193 WHITE/ BLACK	#93194 GRAY
#93195 BLACK/ YELLOW	#93196 RED/ BLACK
#93197 RED/ YELLOW	#93198 BLACK/ BROWN
#93199 ORANGE/ WHITE	
#93200 LIGHT BLUE/ WHITE	

## ■SQ 1.25 (20A/12V) x 1M

#93201 RED	#93203 BLACK
#93202 GREEN	

## ■SQ 2.0 (26A/12V) x 1M

#93204 RED	#93206 BLACK
#93205 GREEN	

## ■SQ 0.5 (11A/12V) x 2M

#65097 RED	#65098 BLACK
#65099 GREEN	

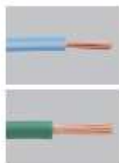

Color	Brand	Usage
RED	UNIVERSAL	
BLACK	UNIVERSAL	
GREEN	UNIVERSAL	
LIGHT BLUE	HONDA	Winker (Right)
ORANGE	HONDA	Winker (Left)
BLUE	HONDA	Headlight (High Beam)
WHITE	HONDA	Headlight (Low Beam)
YELLOW	YAMAHA	Headlight (High Beam), Taillight
GREEN/YELLOW	HONDA	Taillight
BROWN	YAMAHA	ACC Wire
LIGHT GREEN	SUZUKI	Winker (Right)
BLACK/WHITE	SUZUKI	GND Wire
WHITE/BLACK	SUZUKI	Taillight
GRAY	KAWASAKI	Winker (Right)
BLACK/YELLOW	KAWASAKI	GND Wire
RED/BLACK	HONDA	ACC Wire
RED/YELLOW	KAWASAKI	Headlight (High Beam)
BLACK/BROWN	KAWASAKI	Headlight (Low Beam)
ORANGE/WHITE	HONDA	ACC Wire
LIGHTBLUE/WHITE	HONDA	Position Light

# Fuel Hose (1M)

## ■2-layered Fuel Hose



#96460  $\Phi 4 \times \Phi 8$ , 1M  
 #96461  $\Phi 5 \times \Phi 10$ , 1M  
 #96462  $\Phi 6 \times \Phi 10$ , 1M  
 #96463  $\Phi 8 \times \Phi 13$ , 1M  
 #96464  $\Phi 10 \times \Phi 15$ , 1M

- 2-layered
- Pressure capacity 1.0MPa
- Heatproof temperature 100°C
- Incl. 5pcs of clip

※ Not for brake fluid  
 ※ Not for FI models

## ■Hose Clamp



#91238 $\Phi 6$	#91244 $\Phi 12$
#91239 $\Phi 7$	#91245 $\Phi 13$
#91240 $\Phi 8$	#91246 $\Phi 14$
#91241 $\Phi 9$	
#91242 $\Phi 10$	• 2pcs / set
#91243 $\Phi 11$	• Material: Steel

## ■Hose Clip



#91420 $\Phi 6$	• 10pcs / set
#91422 $\Phi 8$	• Material: Steel
#91423 $\Phi 9$	
#91424 $\Phi 11$	
#91425 $\Phi 13$	

## ■Fuel Hose Stopper



#91110  
 • For hose outer diameter up to 15mm  
 ※ Not for negative pressure cock  
 ※ Not for FI models

# Front Lever Lock



#97636 (ORANGE)  
 #97637 (BLACK)  
 #97638 (GREEN)  
 #97639 (RED)  
 Grip mount type  
 I.D. 36mm

# Seat Repair Sticker



84705 (M-BLACK)  
84708 (BLACK)  
84706 (M-BROWN)  
84709 (BROWN)  
84707 (M-BEIGE)  
84710 (BEIGE)

110x170mm  
※ M- ▶matte

# Protection Sticker

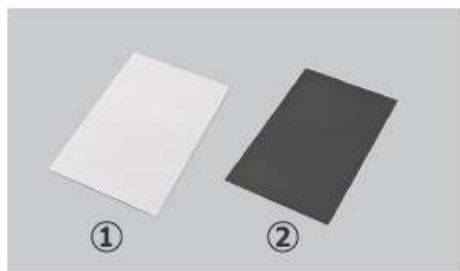

① #69803  
(CLEAR)  
② #69816  
(BLACK)

130x200mm

# Anti-slip Sticker

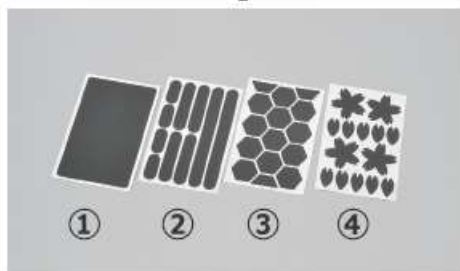

① #17381  
(PLAIN)  
② #17391  
(SLOT)  
③ #17389  
(HONEYCOMB)  
④ #17379  
(SAKURA)

# License Number Plate Holder (Germany)

#89854

- Aluminum
- Anodized black
- For German number plate 180x200



website



Instagram



Youtube



***DAYTONA***

<https://daytona-europe.com>

